**CITY OF MISSION VIEJO
CALIFORNIA
SPECIFICATIONS**

FOR

**MELINDA ROAD PAVEMENT REHABILITATION
FROM OLYMPIAD ROAD TO SANTA MARGARITA PARKWAY**

CIP NO. 837

PREPARED BY

CITY OF MISSION VIEJO
200 Civic Center
Mission Viejo, California 92691
(949) 470-3091

April 2023

These plans and specifications are the exclusive property of the Agency and shall not be used in any manner without prior consent of the Agency.

FEDERAL PROJECT #CRAL-5451(036)

CITY OF MISSION VIEJO
CALIFORNIA

SPECIFICATIONS

FOR

MELINDA ROAD PAVEMENT REHABILITATION
FROM OLYMPIAD ROAD TO SANTA MARGARITA PARKWAY

Prepared By:



Amanda Bajhart, Associate Engineer

4/11/23

Date

Approved By:



Mark Chagnon, Director of Public Works

4/11/23

Date

**CITY OF MISSION VIEJO
TABLE OF CONTENTS**

**MELINDA ROAD PAVEMENT REHABILITATION
FROM OLYMPIAD ROAD TO SANTA MARGARITA PARKWAY**

NOTICE INVITING SEALED BIDS	NB-1
INSTRUCTIONS TO BIDDERS	IB-1
PROPOSAL DOCUMENTS	
Proposal	P-1
Bidder's Information	P-2
List of Subcontractors.....	P-3
References.....	P-4
Designation of Sureties	P-4
Bidder's Statement of Past Contract Disqualifications	P-5
Non-Collusion Affidavit	P-7
Bid Bond.....	P-9
Proposal Bid Sheet.....	P-14
CONTRACT DOCUMENTS	
Contract Agreement	CA-1
Faithful Performance Bond.....	CA-5
Labor and Material Payment Bond	CA-7
Compensation Insurance Certificate.....	CA-9
Required Federal Contract Language (FHWA 1273)	CA-11
GENERAL SPECIFICATIONS	
Scope of Work	GS-1
Location of Work	GS-1
Time of Completion	GS-1
Utility Requirements	GS-1
Flow and Acceptance of Water.....	GS-2
Removal of Water	GS-2
Standard Specifications.....	GS-3
Wage Rates and Labor Codes	GS-3
Clayton and Cartwright Act.....	GS-4
Substitution of Securities	GS-4
Water Pollution Control (NPDES Compliance)	GS-4
SPECIAL PROVISIONS	
PART 1 - GENERAL PROVISIONS	SP-1
PART 2 - CONSTRUCTION MATERIALS	SP-18
PART 3 - CONSTRUCTION METHODS	SP-24
PART 4 – EXISTING IMPROVEMENTS	SP-30
PART 6 – TEMPORARY TRAFFIC CONTROL	SP-33
APPENDICES	
APPLICABLE STANDARD PLANS.....	APPENDIX A
FEDERAL MINIMUM WAGE REQUIREMENTS.....	APPENDIX B
EXCERPTS FROM STATE LABOR CODE.....	APPENDIX C
NOTIFICATION SIGN SPECIFICATIONS AND PLANS.....	APPENDIX D
SANTA MARGARITA WATER DISTRICT ENCROACHMENT PERMIT APPLICATION.....	APPENDIX E

CALTRANS FEDERAL CONTRACT DOCUMENTS..... APPENDIX F
VENDOR APPLICATION FORM..... APPENDIX G
W9 REQUEST FOR TAXPAYER..... APPENDIX H

CITY OF MISSION VIEJO
NOTICE INVITING BIDS
MELINDA ROAD PAVEMENT REHABILITATION
FROM OLYMPIAD ROAD TO SANTA MARGARITA PARKWAY

CIP NO. 837

NOTICE IS HEREBY GIVEN that sealed bids will be received by the **City of Mission Viejo**, as "AGENCY," for furnishing all materials, equipment, tools, labor and incidentals as required for the above-stated project in strict accordance with the specifications and drawings on file at the office of the City Clerk of the **City of Mission Viejo**.

Bids will be received at the office of the City Clerk, 200 Civic Center, **City of Mission Viejo**, until the hour of 10:00 a.m. on May 16, 2023, at which time and place the bids will be publicly opened and read aloud. Bids shall be submitted in sealed envelopes marked on the outside, "**SEALED BID FOR MELINDA ROAD PAVEMENT REHABILITATION FROM OLYMPIAD ROAD TO SANTA MARGARITA PARKWAY.**"

The Work to be constructed under the Contract is located in the **City of Mission Viejo**. The Work to be performed consists of furnishing all materials, equipment, tools, labor, and incidentals as required by the Plans, Specifications, and Contract Documents for the above-stated Contract. The general items of Work to be done hereunder consist of:

Demolition and removals, roadway improvements of failed pavement areas, cold milling AC pavement, resurfacing with ARHM overlay, reconstruction of PCC access ramps, curb, gutter, and sidewalk, adjusting utility structures to new grade, replacing traffic signal loops, striping and pavement markings on Melinda Road from Olympiad Road to Santa Margarita Parkway.

The Agency reserves the right, after opening bids, to reject any or all bids, or to make award to the lowest responsive and responsible bidder and reject all other bids; to waive any informality in the bidding; and to take all bids under advisement for a period of 45 days. Bids will be compared on the basis of the Engineer's estimate of the quantities of the several items of Work as shown on the Bid Sheets. Only such plans, specifications, and items of work as are appropriate shall apply to the Work as bid.

At the time of Contract award to a bidder, the bidder shall possess a Class A Contractor's License, issued by the State of California.

This project involves Federal funding. As such, the Contractor will be required to comply with all Federal requirements contained herein, including Disadvantaged Business Enterprise (DBE) utilization and Underutilized Disadvantaged Business Enterprise (UDBE) utilization, and complete all associated paperwork. See Appendix F. The City of Mission Viejo has established a DBE goal of 6.3% for this project.

Each bid must be accompanied by all required pages of the Proposal (see Instructions to Bidders), including a certified or cashier's check, or a corporate surety bond on the form furnished by the AGENCY, as a guarantee that the bidder will, if an award is made to it in accordance with the terms of its bid, promptly secure workmen's compensation insurance and liability insurance, execute a contract in the required form, and furnish satisfactory bonds for the faithful performance of the contract and for the payment of claims of material and laborers thereunder. Said check or bidder's bond shall be in an amount not less than 10% of the amount of the bid.

The successful bidder will be allowed to substitute securities or establish an escrow in lieu of retainage, pursuant to Public Contract Code Section 22300, and as described in the Agreement between Agency and Contractor and General Conditions.

The Performance and Payment Bonds shall be submitted before execution of the Contract. The Performance Bond shall be not less than 100% of the total amount of the bid price named in the Contract. The Payment Bond shall be not less than 100% of the total amount of the bid price named in the Contract. The AGENCY reserves the right to reject any bond if, in the opinion of the AGENCY Attorney, the Surety's acknowledgment is not in the form included in the Contract Documents or in another form substantially as prescribed by law.

In accordance with provisions of Section 1773.2 (amended 1977) of the California Labor Code, copies of the prevailing rate of per diem wages as determined by the State Director of Industrial Relations are on file in the office of the City Clerk of the **City of Mission Viejo**. It shall be mandatory upon the Contractor to whom the Contract is awarded and

upon any subcontractor under it to pay not less than said specified rates to all workmen employed by them in the execution of the Contract.

The Contractor and all Subcontractors, of any tier, must comply with the requirements of the California Labor Code including but not limited to Sections §§1715.5, 1725.5, 1771.1, 1771.1a, 1771.4(a)(1), 1774, 1775, 1776, 1777.5, 1813 and 1815. A contractor or subcontractor shall not be qualified to submit a bid or to be listed in a bid proposal subject to requirements of Public Contract Code Section 4104, nor shall it be qualified to enter into, or engage in the performance of, any contract of public work, unless it is currently registered and qualified under Labor Code Section 1725.5 to perform public work (as "public work" is defined by Division 2, Part 7, Chapter 1 (§§1720 et seq.) of the Labor Code). [Note: Required in the Notice by Labor Code §1771.1(b).]

Contractors are required to register with the Department of Industrial Relations (DIR). Notwithstanding any other requirements (including federal labor requirements), this contract is subject to compliance monitoring and enforcement by the Department of Industrial relations (DIR).

The City of Mission Viejo hereby notifies all bidders that it will affirmatively ensure that in any Contract entered into pursuant to this advertisement, Disadvantaged Business and Underutilized Disadvantaged Business Enterprises will be afforded full opportunity to submit bids in response to this invitation and will not be discriminated against on the grounds of race, creed, color, or national origin in consideration for an award.

A full set of drawings and specifications is available for inspection without charge at the Engineering Counter at the City Hall of the **City of Mission Viejo**.

Complete sets of said Contract Documents may be purchased at a cost of **\$100.00 (One Hundred Dollars)** per set and are obtainable from the **City of Mission Viejo**, 200 Civic Center, Engineering Counter, Mission Viejo, California 92691, 949-470-3040. No refund will be made of any charges for sets of Contract Documents. Plans and specifications can be mailed for an additional **\$20.00 (Twenty Dollars)** per set. For additional information, contact the Project Manager, Amanda Bajhart, at 949-470-4719 or abajhart@cityofmissionviejo.org.

Dated this 12th day of April, 2023.

Kimberly Schmitt

Kimberly Schmitt
City Clerk

City of Mission Viejo
200 Civic Center
Mission Viejo, California 92691

CITY OF MISSION VIEJO
MELINDA ROAD PAVEMENT REHABILITATION
FROM OLYMPIAD ROAD TO SANTA MARGARITA PARKWAY

CIP NO. 837

1. PROPOSAL FORMS AND REVIEW OF PLANS AND SPECIFICATIONS

Bids shall be submitted in writing on the Proposal forms provided by the AGENCY. All information requested therein must be clearly and legibly set forth in the manner and form indicated. The Proposal must include all pages of the Proposal form with all of the required information, including but not limited to the Bidder's Information, Proposal Bid Sheet, List of Subcontractors, Bidder's Statement of Past Contract Disqualifications, Non-Collusion Affidavit, Bid Bond, Iran Contracting Act Certification (if required), and Sufficient Funds Declaration. The AGENCY will not consider any proposal not meeting these requirements.

In addition, the AGENCY shall not accept any bid or enter into any contract without proof of the Bidder's current registration to perform public work under Labor Code Section 1725.5; and the Bidder shall not accept any sub-bid or enter into any subcontract without proof of the subcontractor's current registration to perform public work under Labor Code Section 1725.5.

Each bidder must review the plans and specifications in its capacity as a contractor prior to submitting its bid, and any errors must be reported to the AGENCY.

2. PROPOSAL GUARANTEE (BID BOND)

Proposals must be accompanied by a proposal guarantee consisting of a certified check or bid bond payable to the AGENCY in the minimum amount of ten percent (10%) of the total amount bid. Any proposal not accompanied by such a guarantee will not be considered. If a bidder to whom a Contract is awarded fails or refuses to execute the Contract Documents or furnish the required insurance policies and bonds as set forth in those documents, the proposal guarantee shall be forfeited to the AGENCY. The proposal guarantees of all bidders will be held until the successful bidder has properly executed all Contract Documents.

3. PROPOSED SCHEDULE

The Contractor shall have Forty-Five (45) Working Days to Complete the Work.

April 12, 2023	Advertise in trade journals and on the Internet
May 16, 2023	Bid opening at 10:00 a.m., City Council Chambers, 1 st floor City Hall
May 25, 2023	Award of contract consideration
June 26, 2023	Construction begins

4. NON-COLLUSION AFFIDAVIT

Bidder shall declare that the only persons or parties interested in the Proposal as principals are those named therein; that no officer, agent, or employee of the AGENCY is personally interested, directly or indirectly, in the Proposal; that the Proposal is made without connection to any other individual, firm, or corporation making a bid for the same Work; and that the Proposal is in all respects fair and without collusion or fraud. The Non-Collusion Affidavit shall be executed and submitted with the Proposal.

5. PROPOSAL BID SHEET

Bidders shall give unit prices for each and all of the items set forth. No aggregate bids will be considered. The bidder shall set forth for each item of Work, in clearly legible figures, a unit item price and a total for the item in the respective spaces provided for this purpose. The quantities listed in the bid sheets are supplied to give an indication of the general scope of Work, but the accuracy of figures is not guaranteed and the bidder shall make its estimates from the drawings. In case of a variation between the unit price and the totals shown by the bidder, the unit price will be considered to be the bid.

6. DELIVERY OF PROPOSAL

Proposals may be mailed or delivered by messenger. However, it is the bidder's responsibility alone to ensure delivery of the Proposal to the hands of the AGENCY's designated official prior to the bid opening hour stipulated in the "Notice Inviting Bids." Late Proposals will not be considered. Proposals shall be enclosed in a sealed envelope plainly marked on the outside, **"SEALED BID FOR MELINDA ROAD PAVEMENT REHABILITATION FROM OLYMPIAD ROAD TO SANTA MARGARITA PARKWAY"**.

7. WITHDRAWAL OF PROPOSALS

A Proposal may be withdrawn by a written request signed by the bidder. Such requests must be delivered to the AGENCY's designated official prior to the bid-opening hour stipulated in the "Notice Inviting Bids." The withdrawal of a Proposal will not prejudice the right of the bidder to submit a new Proposal, providing there is time to do so. Proposals may not be withdrawn after said hour without forfeiture of the proposal guarantee, unless withdrawal is allowed under law.

8. IRREGULAR PROPOSALS

Unauthorized conditions, limitations or provisions attached to a Proposal will render it irregular and may cause its rejection. The completed Proposal forms shall be without interlineations, alterations or erasures. Notwithstanding the foregoing, the City may waive such if allowed by law, and if, in the City's discretion, it deems that waiver is in the City's best interest and that such interlineations, alterations or erasures do not substantially alter the written response or create an unfair advantage to such bidders. Alternative Proposals will not be considered unless specifically requested. No oral, telegraphic or telephonic Proposal, modification or withdrawal will be considered.

9. TAXES

No mention shall be made in the Proposal of Sales Tax, Use Tax, or any other tax, as all amounts bid will be deemed and held to include any such taxes, which may be applicable.

10. DISQUALIFICATION OF BIDDERS

In the event that any bidder on the Contract submits a proposal on another contract on the same work of improvement, all such proposals will be rejected and the bidder will be disqualified. This restriction does not apply to subcontractors or suppliers who may submit quotations to more than one bidder.

The Contract will not be awarded or executed unless the Bidder is licensed in accordance with the provisions of the State Business and Professions Code.

11. INTERPRETATION OF PLANS AND DOCUMENTS

If any person contemplates submission of a bid for the proposed Contract and is in doubt as to the true meaning of any part of the plans, specifications or other proposed Contract Documents, or finds discrepancies in, or omissions from, the drawings or specifications, he may submit to the Engineer of said AGENCY a written request for an interpretation or correction thereof. The person submitting the request will be responsible for its prompt delivery. Any interpretation or correction of the proposed documents shall be made only by addendum duly issued and copy of such addendum will be mailed or delivered to each person receiving a set of such documents. The Engineer will not be responsible for any other explanation or interpretations of the proposed documents.

12. ADDENDA OR BULLETINS

The effect of all addenda to the Contract Documents shall be considered in the bid, and said addenda shall be made a part of the Contract Documents and shall be returned with them. Before submitting its bid, each bidder shall inform itself as to whether or not any addenda have been issued, and failure to cover in this bid any such addenda issued, may render its bid irregular and may result in its rejection by the AGENCY.

13. LEGAL RESPONSIBILITIES

All Proposals must be submitted, filed, made, and executed in accordance with State and Federal laws relating to bids for contracts of this nature whether the same are expressly referred to herein or not.

Any bidder submitting a Proposal shall by such action thereby agree to each and all of the terms, conditions, provisions, and requirements set forth, contemplated, and referred to in the Plans, Specifications, and Contract Documents, and to full compliance therewith.

14. AWARD OF CONTRACT

The award of contract, if made, will be to the most responsible Bidder as determined solely by the City, pursuant to the City's Plans, Specifications and Contract Documents and in the best interests of the City pursuant to law. At the time of contract award, the successful bidder shall hold the contractor's license(s) required in Notice Inviting Bids. Additionally, the AGENCY reserves the right to reject any or all Proposals, to accept any bid, to waive any irregularity if allowed by law, and to take the bids under advisement for the period of time stated in the "Notice Inviting Bids," all as may be required to provide for the best interests of the AGENCY. In no event will an award be made until all necessary investigations are made as to the responsibility and qualifications of the bidder to whom the award is contemplated.

No bidder may withdraw its proposal for a period of forty-five (45) days after the time set for opening thereof, unless permitted by law. However, the AGENCY will return all proposal guarantees within ten (10) days after the award of the Contract or rejection of the bids, as the case may be, to the respective bidders whose Proposals they accompany.

15. LABOR CODE

Pursuant to the provisions of Section 1773 of the Labor Code of the State of California, the AGENCY has obtained the general provisions rate of per diem wages and the general prevailing rate for holiday and overtime work in this locality for each craft, classification, or type of workman needed to execute the Contract from the State Director of the Department of Industrial Relations (DIR). It shall be the responsibility of the prime Contractor to comply with all applicable sections of the Labor Code.

Travel and subsistence payments to each workman needed to execute the Work shall be made as such travel and subsistence payments are defined in the applicable collective bargaining agreements filed in accordance with Section 1773.8 of the Labor Code.

The Contractor shall comply with the provisions of Section 1774 of the Labor Code. Failure to comply with the subject section will subject the Contractor to penalty and forfeiture provisions of Section 1775 of the Labor Code.

Pursuant to the provisions of Section 1770 of the Labor Code, the general prevailing rate of wages has been ascertained (which rate includes employer payments for health and welfare, vacation, pension and similar purposes) applicable to the Work to be done, for straight time, overtime, Saturday, Sunday, and holiday work. The holiday wage rate listed shall be applicable to all holidays recognized in the collective bargaining agreement of the particular craft, classification, or type of workmen concerned.

This project is subject to compliance registration, monitoring, and enforcement by the DIR. (See, among others, Labor Code Sections 1715.5, 1725.5, 1771.1 and 1771.4.)

The AGENCY will not recognize any claim for additional compensation because of the payment by the Contractor of any wage rate in excess of the prevailing wage rate or the Federal Minimum Wage Rate (whichever is greater) as set forth in the Contract. The possibility of wage increases is one of the elements to be considered by the Contractor in determining its bid, and will not under any circumstances be considered as the basis of a claim against the AGENCY on the Contract.

The Contractor and subcontractors shall comply with Section 1777.6 which stipulates that it shall be unlawful to refuse to accept otherwise qualified employees as registered apprentices solely on the grounds of race, religious creed, color, national origin, ancestry, sex, or age, except as provided in Section 3077, of such employee.

16. WORKERS' COMPENSATION CERTIFICATE

Section 3700 of the State Labor Code requires that every employer shall secure the payment compensation by either being insured against liability to pay compensation with one or more insurers or by securing a certificate of consent to self-insure from the State Director of Industrial Relations. In accordance with this section and with Section 1861 of the State Labor Code, the Contractor shall sign a Compensation Insurance Certificate, which is included with the Contract Agreement, and submit same to City along with the other required Contract Documents prior to performing any Work. Reimbursement for this requirement shall be considered as included in the various items of Work.

17. CLAYTON ACT AND CARTWRIGHT ACT

In accordance with Section 7103 of the Public Contract Code, in entering the Contract to supply goods, services, or materials, the Contractor and its subcontractors offer and agree to assign to the AGENCY all rights and interest in and all causes of action it may have under Section 4 of the Clayton Act (15 U.S.C. Sec. 15) or under the Cartwright Act (Chapter 2 [commencing with Section 16700] of Part 2 of Division 7 of the Business and Professions Code), arising from purchases of goods, services, or materials pursuant to the Contract or the subcontracts. This assignment shall be made and become effective at the time the AGENCY tenders final payment to the Contractor, without further acknowledgment by the parties.

18. SUBLETTING AND SUBCONTRACTING

Pursuant to the Subletting and Subcontracting Fair Practices Act (commencing with Section 4100 of the Public Contract Code), bidders are required to list in their Proposal the name, location of place of business, license number, and the portion of the Work of each subcontractor who will perform Work or labor or render services in or about the construction of the Work or improvement, and each subcontractor who specially fabricates and installs a portion of the Work or improvement according to detailed drawings contained in the Plans and Specifications, but only if (a) for a Contract for construction of streets or highways, including bridges, the dollar amount of the subcontractor's work is in excess of \$10,000 or 1/2 of 1% of the total bid in the Proposal, whichever is greater; or (b) for all other Contracts, the dollar amount of the subcontractor's work is in excess of 1/2 of 1% of the total bid in the Proposal. Failure to list a subcontractor for a portion of the work means that the prime Contractor will do that portion of the Work. It is the AGENCY's intent for the Subletting and Subcontracting Fair Practices Act to apply to all phases of the Work.

Attention is directed to the provisions in Sections 10262 and 10262.5 of the Public Contract Code and Section 7108.5 of the Business and Professions Code concerning prompt payment to subcontractors. The Contractor shall return all moneys withheld in retention from the subcontractor within 30 days after receiving payment for Work satisfactorily Completed, even if the other Contract Work is not Completed and has not been accepted by the Agency. This requirement shall not be construed to limit or impair any contractual, administrative, or judicial remedies otherwise available to the Contractor or subcontractor in the event of a dispute involving late payment or nonpayment by the Contractor or deficient subcontract performance or noncompliance by a subcontractor.

19. INSURANCE

Prior to commencement of Work, Contractor shall obtain, provide, and maintain at its own expense policies of insurance of the type and amounts described below and in a form satisfactory to City. If Contractor uses existing coverage to comply with these requirements and that coverage does not meet the requirements set forth herein, Contractor agrees to amend, supplement, or endorse the existing coverage to do so.

General Liability Insurance. Contractor shall maintain a policy of general liability insurance against any and all claims arising out of or in connection with the work performed for this Project with coverage at least as broad as ISO form No. CG 00 01. Contractor shall provide coverage in an amount not less than three million dollars (\$3,000,000.00) per occurrence, six million dollars (\$6,000,000.00) general aggregate, for bodily injury, personal injury, and property damage, and a six million dollar (\$6,000,000.00) completed operations aggregate. The policy must include contractual liability that has not been amended. The policy shall be endorsed to reflect that the per occurrence and aggregate coverage shall apply on a per PROJECT basis, coverage available shall not be eroded by other claims on other projects. This policy shall name City, its officers, officials, employees, agents, and volunteers as additional insureds, covering both ongoing and completed operations, using ISO additional insured endorsement forms CG 20 10 and CG 20 37, or equivalent form(s). Coverage shall apply on a primary, non-contributing basis in relation to any other insurance or self-insurance, primary or excess, available to City or any employee or agent of City. Coverage shall not be limited to the vicarious liability or supervisory role of any additional insured.

Automobile Liability Insurance. Contractor shall maintain automobile insurance at least as broad as Insurance Services Office form CA 00 01 covering bodily injury and property damage for all activities of the Contractor arising out of or in connection with Work to be performed for this Project, including coverage for any owned, hired, non-owned, or rented vehicles, in an amount not less than three million dollars (\$3,000,000.00) combined single limit for each accident.

Workers' Compensation/Employers' Liability. Contractor acknowledges awareness of Section 3700 *et seq.* of the *California Labor Code*, which requires every employer to be insured against liability for workers' compensation. Contractor covenants that it shall comply with such provisions prior to commencement of work performed for this Project. Contractor shall obtain and furnish to City workers' compensation insurance per statutory limits and employer's liability insurance in an amount not less than one million dollars (\$1,000,000.00) per accident for bodily injury or disease. Contractor shall require all subcontractors to provide such workers' compensation and employer's liability insurance for

all of subcontractors' employees. Contractor shall submit to City, along with the certificate of insurance, a waiver of subrogation endorsement in favor of City, its officers, agents, employees, and volunteers. Contractor shall similarly require all subcontractors to waive subrogation.

Contractor's pollution liability insurance. Coverage shall provide for liability arising out of sudden, accidental, and gradual pollution, and remediation. The policy limit shall be no less than one million dollars (\$1,000,000.00) per claim and in the aggregate. All activities contemplated for and during this Project shall be specifically scheduled on the policy as "covered operations." The policy shall provide coverage for remediation of the site in the event of an environmental contamination event arising out of the materials, supplies, products, work, operations, or workmanship. If coverage is provided under a claims-made policy, any policy inception date, continuity date, or retroactive date must be before the effective date of this agreement, and the Consultant agrees to maintain continuous coverage through a period no less than three years after completion of the services required by this agreement.

Umbrella or Excess Liability Insurance. (If required to meet higher limits). Contractor shall obtain and maintain an umbrella liability insurance policy with limits that will provide bodily injury, personal injury, and property damage liability coverage, including commercial general liability, automobile liability, and employer's liability. Such policy or policies shall include the following terms and conditions:

- A. A drop-down feature requiring the policy to respond if any primary insurance that would otherwise have applied proves to be uncollectible in whole or in part for any reason, other than bankruptcy or insolvency of said primary insurer;
- B. "Pay on behalf of" wording as opposed to "reimbursement";
- C. Concurrency of effective dates with primary policies.

Should Contractor obtain and maintain an excess liability policy, such policy shall be excess over commercial general liability, automobile liability, and employer's liability policies. Such policy or policies shall include wording that the excess liability policy follows the terms and conditions of the underlying policies.

Self-Insured Retentions

Any self-insured retentions must be declared to and approved by City. City reserves the right to require that self-insured retentions be eliminated, lowered, or replaced by a deductible, or require proof of ability to pay losses and related investigations, claim administration, and defense expenses within the retention through confirmation from the underwriter.

Other Insurance Provisions

Proof of Insurance. Contractor shall provide certificates of insurance and required endorsements to City as evidence of the insurance coverage required herein. Insurance certificates and endorsements must be approved by City's Risk Management prior to commencement of Work. Current certification of insurance shall be kept on file with City for the contract period and any additional length of time required thereafter. City reserves the right to require complete, certified copies of all required insurance policies, at any time.

Requirements not Limiting. Requirements of specific coverage features or limits contained herein are not intended as a limitation on coverage, limits on other requirements, or a waiver of any coverage normally provided by any insurance. Specific reference to a given coverage feature is for purposes of clarification only as it pertains to a given issue and is not intended by any party or insured to be all inclusive, or to the exclusion of other coverage, or a waiver or limitation of any type. If the Contractor maintains higher limits than the minimums shown above, the City requires and shall be entitled to coverage for the higher limits maintained by the Contractor. Any available insurance proceeds in excess of the specified minimum limits of insurance and coverage shall be available to the City.

Duration of coverage. Contractor shall procure and maintain for the contract period, and any additional length of time required thereafter, insurance against claims for injuries to persons or damages to property, or financial loss which may arise from or in connection with the performance of the Work for this project by Contractor, their agents, representatives, employees, or subcontractors/subconsultants. Contractor must maintain general liability and umbrella or excess liability insurance for as long as there is a statutory exposure to completed operations claims. City and its officers, officials, employees, and agents shall continue as additional insureds under such policies.

Primary/noncontributing. Coverage provided by Contractor shall be primary and any insurance or self-insurance procured or maintained by City shall not be required to contribute with it. The limits of insurance required herein may be satisfied by a combination of primary and umbrella or excess insurance. Any umbrella or excess insurance shall contain or be endorsed to contain a provision that such coverage shall also apply on a primary and non-contributory basis for the benefit of City before City's own insurance or self-insurance shall be called upon to protect it as a named insured.

Products/completed operations coverage. Products/completed operations coverage shall extend a minimum of three (3) years after project completion. Coverage shall be included on behalf of the insured for covered claims arising out of the actions of independent contractors. If the insured is using subcontractors, the Policy must include work performed "by or on behalf" of the insured. Policy shall contain no language that would invalidate or remove the insurer's duty to defend or indemnify for claims or suits expressly excluded from coverage. Policy shall specifically provide for a duty to defend on the part of the insurer. The City, its officials, officers, agents, and employees, shall be included as additional insureds under the Products and Completed Operations coverage.

Waiver of Subrogation. All insurance coverage maintained or procured pursuant to these specifications/for this Project shall be endorsed to waive subrogation against City, its elected or appointed officers, agents, officials, employees, and volunteers or shall specifically allow Contractor or others providing insurance evidence in compliance with these specifications to waive their right of recovery prior to a loss. Contractor hereby waives its own right of recovery against City and shall require similar written express waivers and insurance clauses from each of its subcontractors/subconsultants.

The general liability, automobile liability and umbrella/excess liability policies shall provide/contain, or be endorsed to provide/contain, the following provisions:

1. The City, its officers, officials, employees, agents, and volunteers are to be covered as additional insureds as respects: liability arising out of activities performed by or on behalf of the Contractor, products and Completed operations of the Contractor; premises owned, occupied or used by the Contractor; or automobiles owned, leased, hired, or borrowed by the Contractor. The coverage shall contain no special limitations on the scope of protection afforded to the City, its officers, officials, employees, agents, or volunteers.
2. For any claims related to this project, the Contractor's insurance coverage shall be primary insurance as respects to the City, its officers, officials, employees, agents, or volunteers. Any insurance or self-insurance maintained by the City, its officers, officials, employees, agents, or volunteers shall be in excess of the Contractor's insurance and shall not contribute with it.
3. Any failure to comply with reporting or other provisions of the policies including breaches of warranties shall not affect coverage provided to the City, its officers, officials, employees, agents, or volunteers.
4. The Contractor's insurance shall apply separately to each insured against whom claim is made or suit is brought, except with respect to the limits of the insurer's liability.
5. Each insurance policy required by this clause shall be endorsed to state that coverage shall not be suspended, voided, canceled by either party, reduced in coverage or in limits except after thirty (30) days' prior written notice by certified mail, return receipt required, has been given to the City. Contractor agrees to oblige its insurance agent or broker and insurers to provide the City with a thirty (30) day notice of cancellation (except for nonpayment for which a ten (10) day notice is required) or nonrenewal of coverage for each required coverage. If any of the Contractor's insurers are unwilling to provide such notice, then Contractor shall have the responsibility of notifying City immediately in the event of Contractor's failure to renew any of the required insurance coverages, or insurer's cancellation or non-renewal.

Acceptability of Insurers

Insurance is to be placed with insurers with a current A.M. Best's rating of no less than A:VII.

Verification of Coverage

Contractor shall furnish the City with original endorsements effecting coverage required by this clause. The endorsements are to be signed by a person authorized by that insurer to bind coverage on its behalf. All certificates and endorsements are to be received and approved by the City before Work commences. Contractor's insurer shall provide complete, certified copies of all required insurance policies, including endorsements effecting the coverage required by these specifications.

Contractor acknowledges and agrees that any actual or alleged failure on the part of the City to inform Contractor of non-compliance with any requirement imposes no additional obligations on the City nor does it waive any rights hereunder.

Subcontractors

Contractor agrees to ensure that its subconsultants, subcontractors, and any other party who is brought onto or involved in the project/service by Contractor (hereinafter collectively "subcontractor"), provide the same minimum insurance coverage and endorsements required of Contractor. Contractor agrees to monitor and review all such coverage and assumes all responsibility for ensuring that such coverage is provided in conformity with the requirements of this section. However, in the event Contractor's subcontractor cannot comply with this requirement, which proof must be submitted to the City, Contractor shall be required to ensure that its subcontractor provide and maintain insurance coverage and endorsements sufficient to the specific risk of exposure involved with subcontractor's scope of work and services, with limits less than required of the Contractor, but in all other terms consistent with the Contractor's requirements under this agreement. This provision does not relieve the Contractor of its contractual obligations under the agreement and/or limit its liability to the amount of insurance coverage provided by its subcontractors. This provision is intended solely to provide Contractor with the ability to utilize a subcontractor who may be otherwise qualified to perform the work or services but may not carry the same insurance limits as required of the Contractor under this agreement given the limited scope of work or services provided by the subcontractor. Contractor agrees that upon request, all agreements with subcontractors, and others engaged in the project, will be submitted to City for review.

20. ARBITRATION

Optional Arbitration; Applicable Law

In lieu of litigation of a dispute, the Contractor and City may agree to submit the dispute to binding arbitration so long as agreed by the parties in writing and approved in writing by the Board as an amendment to the Contract Documents. Except as provided below or as may be agreed upon by the parties in writing, (a) any such arbitration shall be governed by Code of Civil Procedure Sections 1280 et seq., and (b) the arbitration award must be supported by law and substantial evidence, and that the award may be vacated if not so supported, per Code of Civil Procedure Section 1296. Should any provision in this "Arbitration" section be found to be unenforceable, then such provision shall be severed and the parties agree that the remaining provisions shall be binding and enforceable as if adopted absent the unenforceable provision. Should the parties wish to modify any provision in this "Arbitration" section, the parties may do so.

Selection of Arbitrator

If the parties agree to binding arbitration, upon notification of a party's election to proceed with arbitration under this section, the parties shall have thirty (30) days to jointly select an arbitrator. In the event that the parties are unable to reach an agreement as to the selection of an arbitrator, an arbitrator will be selected from the American Arbitration Association's panel of construction arbitrators. There shall be no limit on the number of arbitrators that a party can disqualify with respect to the American Arbitration Association's list of arbitrators.

Amount in Controversy/Discovery

If the parties agree to arbitration, the following would apply:

1. If the amount in controversy is less than \$50,000, then, notwithstanding any other provision of law, the only discovery permitted will be (1) the noticing and taking of one deposition (in accordance with Code of Civil Procedure Section 2025) by each party to the dispute and (2) inspection demands pursuant to Code of Civil Procedure Section 2031.
2. If the amount in controversy is equal to or greater than \$50,000 but less than \$150,000, then, notwithstanding any other provision of law, the only discovery permitted will be (1) the noticing and taking of no more than three depositions (in accordance with Code of Civil Procedure Section 2025) by each party to the dispute and (2) inspection demands pursuant to Code of Civil Procedure Section 2031.
3. If the amount in controversy is equal to or greater than \$150,000, then all discovery rules contained in the California Civil Discovery Act, Code of Civil Procedure Section 2016, et seq., shall apply to the arbitration, except each party will only be allowed to propound no more than fifty (50) special interrogatories, and no requests for admissions shall be permitted.

The above deposition limits shall not be applicable to expert depositions. Experts shall be designated and deposed in accordance with Code of Civil Procedure Section 2034.

Procedure/Evidence

If the parties agree to arbitration, the following would apply:

1. General and specific rules of trial procedure and evidence as set forth in the California Code of Civil Procedure and the California Evidence Code, respectfully, shall apply except that the arbitrator may admit any relevant evidence which he believes should be afforded consideration.
2. Motions for summary judgment and/or summary adjudication of issues shall be permitted only if the amount in controversy is equal to or greater than \$50,000. Motions for summary judgment and/or summary adjudication of issues shall be heard in accordance with the Federal Rules of Civil Procedure, Rule 56. The arbitrator shall also have the authority to decide specific legal and/or factual issues by way of a motion for summary judgment and/or summary adjudication of issues regardless of whether or not such resolve a cause of action.
3. Demurrers and motions for judgment on the pleadings shall not be allowed. The arbitrator shall review the pleadings and, in the arbitrator's sole, discretion a dismissal and/or amendment of a pleading can be ordered.
4. The arbitrator shall conduct a pre-arbitration conference for purposes of coordinating the arbitration. At the pre-arbitration conference, all of the following issues shall be addressed: procedural matters, exchange of exhibits, witness lists, motions in limine, arbitration briefs, and the potential for narrowing issues and/or factual disputes by stipulation or by bifurcating the arbitration. The arbitrator can bifurcate specific factual and/or legal issues in addition to causes of action.
5. The arbitrator will close the arbitration hearing after presentation of the evidence and receipt of final briefs, which must be submitted within twenty (20) days from the final presentation of evidence. The time limit within which the award must be filed begins with the closing of the hearing.
6. The arbitrator may for good cause reopen the hearing through request of either party, at any time, before the award is made and/or legal issues in addition to causes of action.
7. The arbitrator's award must be mailed promptly to the parties, but no later than thirty (30) days after the closing of the hearing. The award will be based upon the evidence introduced at the hearing, including all logical and reasonable inferences made therefrom. Pursuant to Code of Civil Procedure Section 1296, the arbitration award must be supported by law and substantial evidence, or else it may be vacated. The arbitrator may grant any remedy that is just and equitable.

Joinder

No arbitration in which the parties elect to participate that arises out of or relates to the contract documents shall include by consolidation, joinder, or any other manner any other person or entity who is not a party to this contract unless:

1. the inclusion of such other person or entity is necessary if complete relief is to be afforded among those who are already parties to the arbitration, and
2. such other person or entity is substantially involved in a question of law or fact which is common to those who are already parties to the arbitration and which will arise in such proceedings, and
3. the written consent of the other person or entity sought to be included and of City and Contractor has been obtained for such inclusion, which consent shall make specific reference to this section; but no such consent shall constitute consent to arbitration of any dispute not specifically described in such consent or to arbitration with any party not specifically identified in such consent.

Costs and Fees

Prior to a decision being rendered in any arbitration, the parties shall split the arbitrator's fees and be responsible for the prompt payment thereof.

Conclusiveness of Judgment

Any arbitration award will be final and binding and there is no direct appeal from the award on the grounds of error in the application of the law or based upon the arbitrator's interpretation of the facts presented. The only reasons for challenging an arbitrator's award are those set forth in the Code of Civil Procedure, Section 1286.2(a), (b), (c) and/or (f), and Section 1296 (failure to base the award on applicable law and substantial evidence). If any party other than the City seeks to challenge the arbitrator's award pursuant to these Code of Civil Procedures sections, such party must post a bond in the amount of 150% of the arbitrator's award (including the award of costs and fees).

Duration

From the time any arbitration proceedings are initiated, such proceedings must be completed within six (6) months, unless (1) the amount in controversy equals or exceeds \$150,000, the arbitration must be completed within one year or (2) the arbitrator extends the completion period for good cause or based upon the stipulation of the parties. Arbitration proceedings shall be deemed initiated upon the appointment of the arbitrator.

21. HOURS FOR PERFORMANCE

Working hours for the construction project will be 8:30 a.m. to 4:30 p.m. on any Working Day. Contractor is to take into special consideration that the nature of the Work is *predominantly near residential properties*. All project Work will not disrupt or conflict with City special events as directed by the Engineer.

Bidder's Name: _____

CITY OF MISSION VIEJO
PROPOSAL
MELINDA ROAD PAVEMENT REHABILITATION
FROM OLYMPIAD ROAD TO SANTA MARGARITA PARKWAY
CIP NO. 837

TO **CITY OF MISSION VIEJO**, as AGENCY:

In accordance with AGENCY's "Notice Inviting Bids", the undersigned bidder ("BIDDER") hereby proposes to furnish all materials, equipment, tools, labor, and incidentals required for the above-stated Contract as set forth in the Plans, Specifications, and Contract Documents therefor, and to perform all Work in the manner and time prescribed therein.

BIDDER declares that this proposal, including the bid sheet, the subcontractor list, the non-collusion declaration, the Iran Contracting Act declaration, and a sufficient funds declaration ("Proposal") is based upon careful examination of the Work site, Plans, Specifications, Notice Inviting Bids, Instructions to Bidders, and other Contract Documents. If this proposal is accepted for award, BIDDER agrees to enter into the Contract with AGENCY at the unit and/or lump sum prices set forth in this Proposal. BIDDER understands that failure to enter into the Contract in the manner and time prescribed will result in forfeiture to AGENCY of the Bid Bond accompanying this proposal.

BIDDER understands that a bid is required for the entire Work, that any estimated quantities set forth in the Proposal are solely for the purpose of comparing bids, and that final compensation under the Contract will be based upon the actual quantities of Work satisfactorily Completed. It is agreed that any unit and/or lump sum prices in the Proposal include all appurtenant expenses, taxes, royalties, and fees. In the case of discrepancies in the amounts bid, unit prices shall govern over extended amounts.

BIDDER agrees and acknowledges that it is aware of the provisions of Section 3700 of the Labor Code, which requires every employer to be insured against liability for workers' compensation or to undertake self-insurance in accordance with the provisions of that code, and that the BIDDER will comply with such provisions of that code before commencing the performance of this Contract if awarded to it.

BIDDER acknowledges this is a Federal-aid construction contract. Additional Federal-aid requirements are:

BIDDER declares that he/she has taken all necessary and reasonable steps to ensure that Disadvantaged Business Enterprises (DBEs) have opportunity to participate in the contract (49 CFR 26).

BIDDER declares **Exhibit 15-G** Local Agency Bidder DBE Commitment (Construction Contracts) form, **Exhibit 12-B** Bidder's List of Subcontractor (DBE and non-DBE), AND **Exhibit 15-H** Proposer/Contractor Good Faith Efforts form is included in this proposal, or if these forms are not submitted with the bid, the BIDDER will submit the forms to the AGENCY no later than 4:00 p.m. on the 4th business day after bid opening unless the AGENCY does not request the forms.

BIDDER agrees and acknowledges that they are aware of **Exhibit 12-G**, "Required Federal Aid Contract Language," and agrees to all of the language including, but not limited to, bidding, Disadvantage Business Enterprise participation, contract award, start of Work, prosecution of Work, purchase of materials, and prosecution of the Work.

BIDDER agrees to the contract award procedure in these Specifications, including those listed in **Exhibit 12-G**, "Required Federal Aid Contract Language," regarding the AGENCY finding any bids non-responsive.

BIDDER certifies that in all previous contracts or subcontracts, all reports that may have been due under the requirements of any agency, State, or Federal equal employment opportunity orders have been satisfactorily filed, and that no such reports are currently outstanding.

BIDDER declares that the only persons or parties interested in this Proposal as principals are those named herein; that no officer, agent, or employee of the AGENCY is personally interested, directly or indirectly, in this Proposal; that this Proposal is made without connection to any other individual, firm, or corporation making a bid for the same work; and that this Proposal is in all respects fair and without collusion or fraud.

BIDDER'S INFORMATION

BIDDER certifies that the following information is true and correct:

Bidder's Name _____

Business Address _____

Telephone: () _____

E-mail _____

State Contractor's License No. and Class _____

Original Date Issued _____ Expiration Date _____

Department of Industrial Relations (DIR) Registration Number _____

The following are the names, titles, addresses, and phone numbers of all individuals, firm members, partners, joint ventures, and/or corporate officers having a principal interest in this proposal:

The dates of any voluntary or involuntary bankruptcy judgments against any principal having an interest in this Proposal are as follows:

All current and prior DBAs, alias, and/or fictitious business names for any principal having an interest in this Proposal are as follows:

Bidder's Name _____

LIST OF SUBCONTRACTORS

All Contractors (and subcontractors) must be registered with the State Division of Industrial Relations and certified to bid on Public Works contracts before bid/proposal submission. Please register at:

<https://mycadir.force.com/registrations/s/login/>

BIDDER proposes to subcontract certain portions of the work, and shall also list these subcontractors in **Exhibit 12-B Bidder's List of Subcontractor (DBE and non-DBE)**, in Appendix F of these documents.

Name of Subcontractor	Contractor's License #	DIR PWCR #	Address/Phone # of Office, Mill or Shop	Percent of Total Contract	Bid Items (List % of Bid Item if Portion Only)

If more space is needed to list subcontractors, please copy this page and fill out.

Bidder's Name _____

REFERENCES

The following are the project names, addresses, contact persons, and phone numbers for all public agencies for which BIDDER has performed similar work within the past two years:

DESIGNATION OF SURETIES

The following are the names, addresses, and phone numbers for all brokers and sureties from whom BIDDER intends to procure insurance and bonds:

Bidder's Name: _____

**CITY OF MISSION VIEJO
PUBLIC WORKS DEPARTMENT**

BIDDER'S STATEMENT OF PAST CONTRACT DISQUALIFICATIONS

The Bidder is required to state any and all instances of being disqualified, removed, or otherwise prevented from bidding on or Completing any contract for construction.

1. Have you ever been disqualified from any contract?

Yes No

2. If yes, explain the circumstances:

Signature of Bidder

Printed Name of Bidder

Bidder's Company

PROPOSAL

IN WITNESS WHEREOF, Bidder executes and submits this Proposal with the names, titles, hands and seals of all forenamed principals this _____ day of _____, 20____.

BIDDER _____

ACKNOWLEDGMENT

A notary public or other officer completing this certificate verifies only the identity of the individual who signed the document to which this certificate is attached, and not the truthfulness, accuracy, or validity of that document.

State of California
County of _____

On _____, before me, _____
(insert name and title of the officer)

personally appeared _____, who proved to me on the basis of satisfactory evidence to be the person(s) whose name(s) is/are subscribed to the within instrument and acknowledged to me that he/she/they executed the same in his/her/their authorized capacity(ies), and that by his/her/their signature(s) on the instrument the person(s), or the entity upon behalf of which the person(s) acted, executed the instrument.

I certify under PENALTY OF PERJURY under the laws of the State of California that the foregoing paragraph is true and correct.

WITNESS my hand and official seal.

Signature _____ **(Seal)**

AGENCY acknowledges that this proposal was received and opened at the time and in the place specified, and that it was accompanied by the required guarantee in the amount of ten percent (10%) of the total bid.

By: _____

Title: _____

**CITY OF MISSION VIEJO
NON-COLLUSION AFFIDAVIT**

(To be executed by Bidder and submitted with its bid)

STATE OF CALIFORNIA)
) ss
COUNTY OF)

_____, being first duly sworn, deposes and says that he or she is
_____ *[insert title]* of _____

[insert bidder name], the party making the foregoing bid that the bid is not made in the interest of, or on behalf of, any undisclosed person, partnership, company, association, organization, or corporation; that such bid is genuine and not collusive or sham; that said bidder has not directly or indirectly induced or solicited any other bidder to put in a false or sham bid, and has not directly or indirectly colluded, conspired, connived, or agreed with any bidder or anyone else to put in a sham bid, or that anyone shall refrain from bidding; that the bidder has not in any manner, directly or indirectly, sought by agreement, communication, or conference with anyone to fix the bid price of the bidder or any other bidder, or to fix any overhead, profit, or cost element of the bid price, or of that of any other bidder, or to secure any advantage against the public body awarding the contract of anyone interested in the proposed contract; that all statements contained in the bid are true; and further, that the bidder has not, directly or indirectly, submitted his or her bid price or any breakdown thereof, or the contents thereof, or divulged information or data relative thereto, or paid, and will not pay, any fee to any corporation, partnership, company association, organization, bid depository, or to any member or agency thereof to effectuate a collusive or sham bid, and has not paid, and will not pay, any person or entity for such purpose.

Any person executing this declaration on behalf of a bidder that is a corporation, partnership, joint venture, limited liability company, limited liability partnership, or any other entity, hereby represents that he or she has full power to execute, and does execute, this declaration on behalf of the bidder.

I declare under the penalty of perjury under the laws of the State of California that the foregoing is true and correct and that this declaration is executed on _____, 20____, at _____, California.

Signed _____

Print Name

Title

ACKNOWLEDGMENT

A notary public or other officer completing this certificate verifies only the identity of the individual who signed the document to which this certificate is attached, and not the truthfulness, accuracy, or validity of that document.

State of California
County of _____

On _____, before me, _____
(insert name and title of the officer)

personally appeared _____, who proved to me on the basis of satisfactory evidence to be the person(s) whose name(s) is/are subscribed to the within instrument and acknowledged to me that he/she/they executed the same in his/her/their authorized capacity(ies), and that by his/her/their signature(s) on the instrument the person(s), or the entity upon behalf of which the person(s) acted, executed the instrument.

I certify under PENALTY OF PERJURY under the laws of the State of California that the foregoing paragraph is true and correct.

WITNESS my hand and official seal.

Signature _____ (Seal)

CITY OF MISSION VIEJO

BID BOND

MELINDA ROAD PAVEMENT REHABILITATION

FROM OLYMPIAD ROAD TO SANTA MARGARITA PARKWAY

(To be submitted by bidder with its bid)

KNOW ALL MEN BY THESE PRESENTS that we _____
 as "Principal/Bidder," and _____ as "Surety," are held
 and firmly bound unto City of Mission Viejo as "Agency" in the penal sum of
 _____ Dollars
 (\$ _____), for the payment of which sum well and truly to be made, we bind ourselves, our heirs, executors,
 administrators and successors, jointly and severally, firmly by these presents.

The conditions of this obligation are such that whereas the Principal/Bidder submitted to the Agency a certain Proposal,
 attached hereto and hereby made a part hereof, to enter into the written Contract for the
 _____ work of improvement and will furnish all required
 certificates of insurance and bonds as required by the Contract.

NOW THEREFORE, if said Proposal shall be rejected; or in the alternate, if said Proposal shall be accepted, and the
 Principal/Bidder shall execute and deliver a contract in the prescribed Form of Agreement, shall deliver certificates
 evidencing that the required insurance is in effect and shall execute and deliver Performance and Payment Bonds in the
 forms prescribed, and shall in all other respects perform the agreement created by the acceptance of said Proposal, then
 this obligation shall be void; otherwise, this obligation shall remain in force and effect, it being expressly understood and
 agreed that the liability of the Surety for any and all default of the Principal/Bidder hereunder shall be the amount of this
 obligation as herein stated.

The Surety, for the value received, hereby stipulates and agrees that the obligations of said Surety and its bond shall in no
 way be impaired or affected by an extension of the time within which the Agency may accept such a proposal; and said
 Surety does hereby waive notice of any such extension.

BID BOND (Page Two)

IN WITNESS WHEREOF, the above-bounded parties have executed this instrument under their several seals this _____ day of _____, 20____, the name and corporate seal of each corporate party being hereto affixed and these presents duly signed by its undersigned representative, pursuant to authority of its governing body.

ATTEST:

(Principal/Bidder) _____
(Address) _____

(By) _____
(Title) _____

NOTE: SIGNATURE OF CORPORATE OFFICIALS MUST BE NOTARIZED

ATTEST:

(Surety) _____
(Address) _____

(By) _____
(Title) _____

NOTE: SIGNATURE OF SURETY OFFICIALS MUST BE NOTARIZED

BOND APPROVED AS TO FORM:

William P. Curley, III
City Attorney
City of Mission Viejo

ACKNOWLEDGMENT

A notary public or other officer completing this certificate verifies only the identity of the individual who signed the document to which this certificate is attached, and not the truthfulness, accuracy, or validity of that document.

State of California
County of _____

On _____, before me, _____
(insert name and title of the officer)

personally appeared _____, who proved to me on the basis of satisfactory evidence to be the person(s) whose name(s) is/are subscribed to the within instrument and acknowledged to me that he/she/they executed the same in his/her/their authorized capacity(ies), and that by his/her/their signature(s) on the instrument the person(s), or the entity upon behalf of which the person(s) acted, executed the instrument.

I certify under PENALTY OF PERJURY under the laws of the State of California that the foregoing paragraph is true and correct.

WITNESS my hand and official seal.

Signature _____ **(Seal)**

CITY OF MISSION VIEJO

IRAN CONTRACTING ACT CERTIFICATION
(Public Contract Code Sections 2202-2208)

MELINDA ROAD PAVEMENT REHABILITATION
FROM OLYMPIAD ROAD TO SANTA MARGARITA PARKWAY

(To be executed by bidder and submitted with its bid)

As required by Public Contract Code (“PCC”) §2204 for contracts of \$1,000,000 or more, please insert Bidder’s or financial institution’s name and Federal ID Number (if available) and complete **one** of the options below. Please note that California law establishes penalties for providing false certifications, including civil penalties equal to the greater of \$250,000 or twice the amount of the contract for which the false certification was made; contract termination; and three-year ineligibility to bid on contracts. (PCC §2205.)

OPTION #1 - CERTIFICATION

I, the official named below, certify I am duly authorized to execute this certification on behalf of the bidder/financial institution identified below, and the bidder/financial institution identified below is **not** on the current list of persons engaged in investment activities in Iran created by California Department of General Services (“DGS”) and is not a financial institution extending Twenty Million Dollars (\$20,000,000) or more in credit to another person/bidder, for 45 days or more, if that other person/bidder will use the credit to provide goods or services in the energy sector in Iran and is identified on the current list of persons engaged in investment activities in Iran created by DGS. (PCC §2204(a).)

<i>Bidder Name/Financial Institution (Printed)</i>		<i>Federal ID Number (or N/A)</i>
<i>By (Authorized Signature)</i>		
<i>Printed Name and Title of Person Signing</i>		
<i>Date Executed</i>	<i>Executed in</i>	

OPTION #2 – EXEMPTION

Pursuant to Public Contract Code §§2203(c) and (d), a public entity may permit a bidder/financial institution engaged in investment activities in Iran, on a case-by-case basis, to be eligible for, or to bid on, submit a proposal for, or enters into or renews, a contract for goods and services. If you have obtained an exemption from the certification requirement under the Iran Contracting Act, please fill out the information below, and attach documentation demonstrating the exemption approval.

<i>Bidder Name/Financial Institution (Printed)</i>		<i>Federal ID Number (or N/A)</i>
<i>By (Authorized Signature)</i>		
<i>Printed Name and Title of Person Signing</i>		<i>Date Executed</i>

CITY OF MISSION VIEJO
SUFFICIENT FUNDS DECLARATION
(Labor Code Section 2810)

MELINDA ROAD PAVEMENT REHABILITATION
FROM OLYMPIAD ROAD TO SANTA MARGARITA PARKWAY

(To be executed by bidder and submitted with its bid)

Owner: **City of Mission Viejo**
Contract: _____ Project

I, _____, declare that I am the _____
[insert title] of _____ [the entity], the entity making and submitting the bid for the
above Contract that accompanies this Declaration, and that such bid includes sufficient funds to permit
_____ [the entity] to comply with all local, State or Federal labor laws or regulations
during performance of the Contract, including payment of prevailing wage, and that _____
[the entity] will comply with the provisions of Labor Code Section 2810(d) if awarded the Contract.

I declare under penalty of perjury under the laws of the State of California that the foregoing is true and correct
and executed on _____ 20____, at _____ [City], _____ [State].

Date: _____

Signature

Print Name: _____

Print Title: _____

Bidder's Name: _____

CITY OF MISSION VIEJO

PROPOSAL BID SHEET

**MELINDA ROAD PAVEMENT REHABILITATION
FROM OLYMPIAD ROAD TO SANTA MARGARITA PARKWAY**

The following estimate of quantities of Work to be done and materials to be furnished are approximate only. It is given as a basis for comparison of bids and the City does not expressly or by implication agree that the actual amount of Work will correspond therewith. The City reserves the right to increase or decrease the amount of Work, or to omit portions of the Work that may be deemed necessary or expedient by the City.

BID SCHEDULE

Item No.	Description	Unit	Quantity	Unit Price	Total Price
1	Mobilization	LS	1	\$	\$
2	Remove Existing PCC Walk and Construct New Sidewalk Per City Of Mission Viejo Standard Plan No 321. Cut And Remove Tree Roots. City Inspector To Mark Limits	SF	878	\$	\$
3	Remove Existing Curb and Gutter And Construct New Type A-8 Curb And Gutter Per City Of Mission Viejo Standard Plan No 316 with 12" Wide AC Slot Patch Per Detail On Sheet 2. City Inspector To Mark Limits	LF	722	\$	\$
4	Remove Existing And Construct New PCC Curb Ramp With No Curb And Gutter Per City Of Mission Viejo Std. Plan 322 ("Armor-Tile® Surface Applied" Detectable Warning Mats In Dark Grey (#36118) Or Engineer-Approved Equivalent with Adhesive and Fasteners Per Manufacturer's Recommendations And At Locations Marked On The Plans)	SF	5,925	\$	\$
5	Remove Existing Asphalt To A Depth of 4" And Re-Pave With 4" Thick AC Base Course, Type III-B2-PG 64-10. City Inspector To Mark Limits	CF	6,833	\$	\$
6	Edge And Transition Cold Milling (1.5" to 0")	SF	69,017	\$	\$
7	Crack Sealing	LS	1	\$	\$
8	1.5" ARHM Overlay ¹	TONS	3,076	\$	\$
9	Double-Adjust Storm Drain Manhole Frame and Cover To Grade	EA	1	\$	\$
10	Adjust Storm Drain Manhole Frame and Cover To Grade	EA	14	\$	\$
11	Adjust Water Valve Frame And Cover To Grade	EA	24	\$	\$
12	Adjust Sewer Manhole Frame and Cover To Grade	EA	12	\$	\$
13	Adjust Well Monument Cover To Grade	EA	7	\$	\$
14	Double Adjust Water Valve Frame And Cover To Grade	EA	1	\$	\$

Item No.	Description	Unit	Quantity	Unit Price	Total Price
15	Adjust Water Meter Box To Grade	EA	2	\$	\$
16	Striping, Pavement Markings, and Signage ²	LS	1	\$	\$
17	Replace Traffic Signal Loop Detectors (Type E)	EA	19	\$	\$
18	Replace Traffic Signal Loop Detectors (Type E Modified)	EA	5	\$	\$
19	Portable Changeable Message Sign (CMS) Rental (Per Day Per Sign) ³	DAYS	90	\$	\$
20	Fabricate Notification Sign and Install ⁴	EA	2	\$	\$
21	Santa Margarita Water District Encroachment Permit	ALLOW- ANCE	1	\$1500	\$1500
Total Bid Amount					\$

Total Bid Amount in Words: _____ Dollars

The City will determine the low bidder in the manner stated in the Notice Inviting Bids. Contractor agrees that its bid, or any bid item, will not be invalidated by such determination.

In case of a variation between the unit price and the totals shown by Bidder, the unit price will be considered to be the bid.

Important Bid Item Notes

- Subsection 6-2 of the Special Provisions require the Contractor to construct ARHM overlay for any given portion of the roadway no more than two (2) working days following the cold milling for the same portion of roadway. Consequently, after cold-milling operations commence, the City expects that the contractor will be cold-milling one roadway segment while simultaneously paving another segment.**
- The first coat of striping and pavement markings for any given portion of the roadway shall be placed no more than three calendar days following the ARHM Overlay. The Contractor shall include in its lump sum bid price, the re-painting (one coat only) of existing traffic striping and pavement markings outside the limits of work, which are tarnished by the Contractor's operations.
- Contractor shall make two (2) portable electronic changeable message signs available for rental by the City on a per-day rental basis. The Contractor shall honor its bid price regardless of the quantity utilized. See Subsection 601-3.7.5 for important details regarding type of message board and reprogramming requirements.
- See **Appendix V** for requirements. The Contractor shall honor its bid price regardless of the quantities utilized.

The Contractor shall complete this Proposal Bid Sheet for use only by Agency for comparison of bids and compensation to the Contractor for this project. The estimated quantities and itemized descriptions listed in the Proposal Bid Sheets are supplied to give an indication of the general size of the work. Unit prices are intended to be the basis additions, deletions or substitutions to the work, if required. The accuracy of the estimated quantities is not guaranteed. The Bidder shall make his own estimate from information included in the Contract Documents and from field inspections. **The Work to be performed shall include, but not be limited to, the items described. The bid shall include the furnishing of labor, services, tools, equipment, materials, appurtenances, and incidentals necessary to install or Complete all Work contemplated per the plans and specifications. Any Work required per the plans and specifications for which there is no specific bid item shall be considered as included in the various bid items of Work (unless listed by Bidder under miscellaneous elements) and no additional compensation will be**

allowed therefor. The City reserves the right to increase or decrease the amount of any class or portion of the Work, or to omit portions of the Work that may be deemed necessary or expedient by the City.

NOTE: The City places special emphasis on the presence of the Contractor's representative at all times while Work is being performed. A representative from the prime Contractor shall be present at all times. The Contractor must include this cost in its bid. Failure to have the prime Contractor's representative present in accordance with Section 7-6 of the Standard Specifications shall result in the deduction of \$1,000 per day from progress payments to the Contractor. The unit quantities listed in the Proposal Bid Sheet are approximate only. Upon Completion of construction, if the actual quantities show either an increase or decrease from the quantities given in the Proposal Bid Sheet, the Contract Unit Prices will prevail subject to the provisions of Subsection 3-2.2.1 (unless otherwise specified). Payment will not be made for materials wasted or disposed of in a manner not called for under the Contract; this includes rejected material not unloaded from vehicles, material rejected after is has been placed and material placed outside of the Plan lines. No compensation will be allowed for disposing of rejected or excess material.

Proposals must be accompanied by a proposal guarantee consisting of a certified check or bid bond payable to the AGENCY in the amount of ten percent (10%) of the total amount bid.

Bidder's Name _____

Telephone No. _____

Bidder shall signify receipt of all Addenda here, if any:

<u>Addendum No.</u>	<u>Date Received</u>	<u>Bidder's Signature</u>
_____	_____	_____
_____	_____	_____
_____	_____	_____
_____	_____	_____

**CITY OF MISSION VIEJO
CONTRACT AGREEMENT**

**MELINDA ROAD PAVEMENT REHABILITATION
FROM OLYMPIAD ROAD TO SANTA MARGARITA PARKWAY**

CIP NO. 837

THIS CONTRACT AGREEMENT is made and entered into for the above-stated project this _____ day of _____, 20__, BY AND BETWEEN THE **CITY OF MISSION VIEJO**, as City and _____ as CONTRACTOR.

WITNESSETH that CITY and CONTRACTOR have mutually agreed as follows:

Article I

The contract documents for the aforesaid project shall consist of the Notice Inviting Bids, Instructions to Bidders, Proposal, General Specifications, Special Provisions in accordance with the Standard Specifications for Public Works Construction, Faithful Performance Bond, Labor and Material Bond, and all referenced specifications, details, Standard Plans and appendices, including all applicable State and Federal requirements; together with this Contract Agreement and all required bonds, insurance certificates, permits, notices and affidavits; and also including any and all addenda or supplemental agreements clarifying, amending or extending the work contemplated as may be required to insure its completion in an acceptable manner (collectively all the foregoing shall be referenced as the "Contract Documents"). All of the provisions of said contract documents are made a part hereof as though fully set forth herein.

Article II

For and in consideration of the payments and agreements to be made and performed by CITY, CONTRACTOR agrees to furnish all materials and perform all work required for the above stated project and to fulfill all other obligations as set forth in the aforesaid Contract Documents.

Article III

CONTRACTOR agrees to receive and accept the prices set forth in the proposal as full compensation for furnishing all materials, performing all work and fulfilling all obligations hereunder. Said compensation shall cover all expenses, losses, damages, and consequences arising out of the nature of work during its progress or prior to its acceptance, including those for well and faithfully completing the work and the whole hereof in the manner and time specified in the aforesaid Contract Documents; and also including those arising from actions of the elements, unforeseen difficulties or obstructions encountered in the prosecution of the work, suspension or discontinuance of the work, and all other unknowns or risks of any description connected with the work.

Article IV

CITY hereby promises and agrees to employ, and does hereby employ, CONTRACTOR to provide the materials, do the work and fulfill the obligations according to the terms and conditions herein contained and referred to, for the prices aforesaid, and hereby contracts to pay the same at the time, in the manner and upon the conditions set forth in the Contract Documents.

The total amount of this contract shall not exceed _____ Dollars (\$_____). CONTRACTOR shall not be compensated for any services rendered in connection with its performance of this agreement which are in addition to those set forth herein, unless such additional services are authorized in advance and in writing by the City Council, or if pursuant to its authority, the City Manager, or his or her designee. CONTRACTOR shall be compensated for any additional services in the amounts and in the manner as agreed to by the City Manager or City representative and CONTRACTOR at the time City's written authorization is given to CONTRACTOR for the performance of said services. The City Manager may approve additional work not to exceed 15% of the contract amount approved by City Council or \$30,000 whichever is less. Any additional work in excess of this amount shall be approved by the City Council.

Article V

CONTRACTOR acknowledges the provisions of the State Labor Code requiring every employee to be insured against liability for Worker's Compensation or to undertake self-insurance in accordance with the provisions of that code, and certifies compliance with such provisions.

Article VI

CONTRACTOR agrees to indemnify and hold harmless CITY and all of its officers, officials, consultants, employees, agents, and volunteers from any claims, demands or causes of action, including related expenses, attorney's fees and costs, based on, arising out of, or in any way related to the work undertaken by CONTRACTOR hereunder.

Article VII

CONTRACTOR affirms that the signatures, titles, and seals set forth herein in execution of this Contract Agreement represent all individuals, firm members, partners, joint venturers, and/or corporate officers having a principal interest herein.

IN WITNESS WHEREOF the parties hereto have caused this Agreement to be executed the day and year first written.

CONTRACTOR

CITY OF MISSION VIEJO

Name _____
Title _____

Date _____

Dennis Wilberg _____
City Manager _____

Date _____

ATTEST:

Name _____
Title _____

Date _____

Kimberly Schmitt _____
City Clerk _____

Date _____

APPROVED AS TO FORM:

William P. Curley, III _____
City Attorney _____

Date _____

Heather Campbell _____
Risk Management Administrator _____

Date _____

NOTE: SIGNATURES OF CORPORATE OFFICIALS MUST BE NOTARIZED

NOTE: FHWA FORM-1273, LOCATED AT THE END OF THIS SECTION, SHALL BE CONSIDERED PART OF THIS CONTRACT FORM.

ACKNOWLEDGMENT

A notary public or other officer completing this certificate verifies only the identity of the individual who signed the document to which this certificate is attached, and not the truthfulness, accuracy, or validity of that document.

State of California
County of _____

On _____, before me, _____
(insert name and title of the officer)

personally appeared _____,
who proved to me on the basis of satisfactory evidence to be the person(s) whose name(s) is/are
subscribed to the within instrument and acknowledged to me that he/she/they executed the same in
his/her/their authorized capacity(ies), and that by his/her/their signature(s) on the instrument the
person(s), or the entity upon behalf of which the person(s) acted, executed the instrument.

I certify under PENALTY OF PERJURY under the laws of the State of California that the foregoing
paragraph is true and correct.

WITNESS my hand and official seal.

Signature _____ (Seal)

Premium \$ _____
Premium will be based on final contract amount.

Bond No.: _____

**CITY OF MISSION VIEJO
FAITHFUL PERFORMANCE BOND**

**MELINDA ROAD PAVEMENT REHABILITATION
FROM OLYMPIAD ROAD TO SANTA MARGARITA PARKWAY**

CIP NO. 837

THAT, WHEREAS, the City of Mission Viejo, State of California, entered into a contract dated _____, 20____, hereinafter called "Contract," with _____ (name and address of contractor), hereinafter called "Principal," for the work described as follows:

Demolition and removals, roadway improvements, drainage, bridge and wall structures, utility relocations/adjustments, traffic signal and electrical modifications, landscaping and irrigation, reclaimed waterline improvements, and all appurtenant work.

and

WHEREAS, the said Principal is required under the terms of said Contract to furnish a bond for the faithful performance of said Contract.

NOW, THEREFORE, WE, the Principal and _____, duly authorized to transact business under the laws of the State of California, as Surety, hereinafter called "Surety," are held and firmly bound unto the City of Mission Viejo in the penal sum of _____ Dollars (\$_____), lawful money of the United States, said sum being not less than one hundred percent (100%) of the estimated amount payable by the said City of Mission Viejo under the terms of the Contract for the payment of which we bind ourselves, our heirs, executors, administrators, successors, and assigns, jointly and severally, firmly by these presents.

THE CONDITION OF THIS OBLIGATION is such that, if said Principal, its heirs, executors, administrators, successors, or assigns, shall in all things stand to, abide by, and well and truly keep and perform the covenants, conditions, and agreements in the said Contract, and in any alteration thereof made as therein provided, on its part to be kept and performed, at the time and in the intent and meaning, and shall indemnify, and save and hold harmless the City of Mission Viejo, its officers, officials, employees, agents, and volunteers as therein stipulated, then this obligation shall become null and void; otherwise it shall be and remain in full force and virtue.

As part of the obligation secured hereby and in addition to the face amount specified, costs and reasonable expenses and fees shall be included, including reasonable attorney's fees incurred by the City of Mission Viejo in successfully enforcing the obligation, all to be taxed as costs and included in any judgment rendered

FAITHFUL PERFORMANCE BOND (Page 2)

The Surety hereby stipulates and agrees that no change, extension of time, alteration, or addition to the terms of the Contract, or to the work to be performed thereunder, or to the specifications accompanying the same, shall in any way affect its obligations on this bond, and it does hereby waive notice of any such change, extension of time, alteration, or addition to the terms of the Contract, or to the work, or to the specifications.

IN WITNESS WHEREOF, this instrument has been duly executed by the Principal and Surety above named, on _____, 20_____.

(Seal)

(Seal)

SURETY:

PRINCIPAL:

By: _____

By: _____

Name: _____

Name: _____

Title: _____

Title: _____

By: _____

Name: _____

Title: _____

APPROVED AS TO FORM:

Premium \$ _____
Premium will be based on final contract amount.

William P. Curley, III
City Attorney, City of Mission Viejo

**CITY OF MISSION VIEJO
LABOR AND MATERIAL PAYMENT BOND**

**MELINDA ROAD PAVEMENT REHABILITATION
FROM OLYMPIAD ROAD TO SANTA MARGARITA PARKWAY**

CIP NO. 837

THAT, WHEREAS, the City of Mission Viejo has awarded to _____
_____ (name and address of contractor),
hereinafter called "Contractor," a contract for the work described as follows:

Demolition and removals, roadway improvements of failed pavement areas, cold milling AC pavement, resurfacing with ARHM overlay, reconstruction of PCC access ramps, curb, gutter, and sidewalk, adjusting utility structures to new grade, replacing traffic signal loops, striping and pavement markings on Melinda Road from Olympiad Road to Santa Margarita Parkway

and

WHEREAS, said Contractor is required by the provisions of Sections 3247-3252 of the Civil Code to furnish a bond in connection with said Contract, as hereinafter set forth.

NOW, THEREFORE, WE, the undersigned Contractor as Principal, and _____
_____, duly authorized to transact business under the laws of the State of California, as Surety, hereinafter called "Surety," are held and firmly bound unto the City of Mission Viejo, California, and all contractors, subcontractors, laborers, materialmen, and other persons employed in the performance of the aforesaid Contract and referred to in Title 15 of the Civil Code, in the penal sum of _____ Dollars (\$ _____), lawful money of the United States, said sum being not less than one hundred percent (100%) of the estimated amount payable by the said City of Mission Viejo under the terms of the Contract for the payment of which we bind ourselves, our heirs, executors, administrators, successors, and assigns, jointly and severally, firmly by these presents.

THE CONDITION OF THIS OBLIGATION is such that, if said Principal, its heirs, executors, administrators, successors and assigns, or subcontractors, shall fail to pay for any materials, provisions, provender or other supplies, or teams, implements or machinery, used in, upon, for or about the performance of the work under the Contract to be done, or for any work or labor thereon of any kind or for amounts due under the Unemployment Insurance Code with respect to such work or labor, as required by the provisions of Chapter 7 of Title 5 of Part 4 of Division 3 of the Civil Code, and provided that the claimant shall have complied with the provisions of said Civil Code, the Surety shall pay for the same in an amount not exceeding the sum specified in this bond; otherwise, the above obligation shall be void. In case suit is brought upon this bond, the Surety will pay costs and reasonable expenses and fees, including reasonable attorneys' fees to be fixed by the Court.

This bond shall inure to the benefit of any and all persons, companies, and corporations entitled to file claims under Section 3181 of the Civil Code, so as to give a right of action to them or their assigns in any suit brought upon this bond, and shall also cover payment for any amounts required to be deducted, withheld, and paid over to the Employment Development Department from the wages of employees of the Contractor or his or its subcontractors pursuant to Section 13020 of the Unemployment Insurance Code.

LABOR AND MATERIAL PAYMENT BOND (Page 2)

The Surety hereby stipulates and agrees that no change, extension of time, alteration, or addition to the terms of the Contract, or to the work to be performed thereunder, or to the specifications accompanying the same, shall in any way affect its obligations on this bond. The Surety hereby waives notice of any such change, extension of time, alteration or addition to the terms of the Contract, or to the work to be performed thereunder, or to the specifications accompanying the same.

IN WITNESS WHEREOF, this instrument has been duly executed by the Principal and Surety above named, on _____, 20____

(Seal)

SURETY:

By: _____

Name: _____

Title: _____

(Seal)

PRINCIPAL:

By: _____

Name: _____

Title: _____

By: _____

Name: _____

Title: _____

APPROVED AS TO FORM:

Premium \$ _____
Premium will be based on final contract amount.

William P. Curley, III
City Attorney, City of Mission Viejo

**CITY OF MISSION VIEJO
COMPENSATION INSURANCE CERTIFICATE**

**MELINDA ROAD PAVEMENT REHABILITATION
FROM OLYMPIAD ROAD TO SANTA MARGARITA PARKWAY**

CIP NO. 837

Pursuant to Section 1861 of the State Labor Code (amended by Stats. 1979, C.373, p. 1343), before beginning work, the Contractor shall furnish to the City Engineer a certificate of insurance for all persons whom he may employ directly or through subcontractors in carrying out the work specified herein, in accordance with the laws of the State of California. Such insurance shall be maintained in full force and effect during the period covered by this contract.

Before beginning work, the Contractor shall furnish to the City Engineer a certificate of insurance as proof that he has taken out full compensation insurance for all persons whom he may employ directly or through subcontractors in carrying out the work specified herein, in accordance with the laws of the State of California. Such insurance shall be maintained in full force and effect during the period covered by this contract.

Contractor, prior to commencing work, shall sign and file with the City of Mission Viejo a certification as follows:

I am aware of the provisions of Section 3700 of the Labor Code which requires every employer to be insured against liability for Worker's Compensation or to undertake self-insurance in accordance with the provisions of that Code, and I will comply with such provisions before commencing the performance of the work of this contract.

CONTRACTOR

By: _____

Title: _____

Date: _____

Section 3700 of the State Labor Code reads as follows:

"Every employer except the State shall secure the payment of compensation in one or more of the following ways:

- (a) By being insured against liability to pay compensation in one or more insurers duly authorized to write compensation insurance in the state.
- (b) By securing from the Director of Industrial Relations a certificate of consent to self-insure, which may be given upon furnishing proof satisfactory to the Director of Industrial Relations of ability to self-insure and to pay any compensation that may become due to his employee."

(Amended by Stats, 1978, c. 1379, p. 4571)

Compensation Insurance Certificate

To be submitted with Contract Agreement

FHWA 1273

Referenced Hereon

**REQUIRED CONTRACT
PROVISIONS FEDERAL-AID
CONSTRUCTION CONTRACTS**

- I. General
- II. Nondiscrimination
- III. Non-segregated Facilities
- IV. Davis-Bacon and Related Act Provisions
- V. Contract Work Hours and Safety Standards Act Provisions
- VI. Subletting or Assigning the Contract
- VII. Safety: Accident Prevention
- VIII. False Statements Concerning Highway Projects
- IX. Implementation of Clean Air Act and Federal Water Pollution Control Act
- X. Certification Regarding Debarment, Suspension, Ineligibility and Voluntary Exclusion
- XI. Certification Regarding Use of Contract Funds for Lobbying
- XII. Use of United States-Flag Vessels:

ATTACHMENTS

A. Employment and Materials Preference for Appalachian Development Highway System or Appalachian Local Access Road Contracts (included in Appalachian contracts only)

I. GENERAL

1. Form FHWA-1273 must be physically incorporated in each construction contract funded under title 23, United States Code, as required in 23 CFR 633.102(b) (excluding emergency contracts solely intended for debris removal). The contractor (or subcontractor) must insert this form in each subcontract and further require its inclusion in all lower tier subcontracts (excluding purchase orders, rental agreements and other agreements for supplies or services). 23 CFR633.102(e).

The applicable requirements of Form FHWA-1273 are incorporated by reference for work done under any purchase order, rental agreement or agreement for other services. The prime contractor shall be responsible for compliance by any subcontractor, lower-tier subcontractor or service provider. 23 CFR 633.102(e).

Form FHWA-1273 must be included in all Federal-aid design-build contracts, in all subcontracts and in lower tier subcontracts (excluding subcontracts for design services, purchase orders, rental agreements and other agreements for supplies or services) in accordance with 23 CFR 633.102. The design-builder shall be responsible for compliance by any subcontractor, lower-tier subcontractor or service provider.

Contracting agencies may reference Form FHWA-1273 in solicitation-for-bids or request-for-proposals documents, however, the Form FHWA-1273 must be physically incorporated (not referenced) in all contracts, subcontracts and lower-tier subcontracts (excluding purchase orders, rental agreements and other agreements for supplies or services related to a construction contract). 23 CFR 633.102(b).

2. Subject to the applicability criteria noted in the following sections, these contract provisions shall apply to all work performed on the contract by the contractor's own organization and with the assistance of workers under the contractor's immediate superintendence and to all work performed on the contract by piecework, station work, or by subcontract. 23 CFR 633.102(d).

3. A breach of any of the stipulations contained in these Required Contract Provisions may be sufficient grounds for withholding of progress payments, withholding of final payment, termination of the contract, suspension / debarment or any other action determined to be appropriate by the contracting agency and FHWA.

4. Selection of Labor: During the performance of this contract, the contractor shall not use convict labor for any purpose within the limits of a construction project on a Federal-aid highway unless it is labor performed by convicts who are on parole, supervised release, or probation. 23 U.S.C. 114(b). The term Federal-aid highway does not include roadways functionally classified as local roads or rural minor collectors. 23 U.S.C. 101(a).

II. NONDISCRIMINATION (23 CFR 230.107(a); 23 CFR Part 230, Subpart A, Appendix A; EO 11246)

The provisions of this section related to 23 CFR Part 230, Subpart A, Appendix A are applicable to all Federal-aid construction contracts and to all related construction subcontracts of \$10,000 or more. The provisions of 23 CFR Part 230 are not applicable to material supply, engineering, or architectural service contracts.

In addition, the contractor and all subcontractors must comply with the following policies: Executive Order 11246, 41 CFR Part 60, 29 CFR Parts 1625-1627, 23 U.S.C. 140, Section 504 of the Rehabilitation Act of 1973, as amended (29 U.S.C. 794), Title VI of the Civil Rights Act of 1964, as amended (42 U.S.C. 2000d et seq.), and related regulations including 49 CFR Parts 21, 26, and 27; and 23 CFR Parts 200, 230, and 633.

The contractor and all subcontractors must comply with: the requirements of the Equal Opportunity Clause in 41 CFR 60-1.4(b) and, for all construction contracts exceeding \$10,000, the Standard Federal Employment Opportunity Construction Contract Specifications in 41 CFR 60-4.3.

Note: The U.S. Department of Labor has exclusive authority to determine compliance with Executive Order 11246 and the policies of the Secretary of Labor including 41 CFR Part 60, and 29 CFR Parts 1625-1627. The contracting agency and the FHWA have the authority and the responsibility to ensure compliance with 23 U.S.C. 140, Section 504 of the Rehabilitation Act of 1973, as amended (29 U.S.C. 794), and Title VI of the Civil Rights Act of 1964, as amended (42 U.S.C. 2000d et seq.), and related regulations including 49 CFR Parts 21, 26, and 27; and 23 CFR Parts 200, 230, and 633.

The following provision is adopted from 23 CFR Part 230, Subpart A, Appendix A, with appropriate revisions to conform to the U.S. Department of Labor (US DOL) and FHWA requirements.

1. Equal Employment Opportunity: Equal Employment Opportunity (EEO) requirements not to discriminate and to take affirmative action to assure equal opportunity as set forth under laws, executive orders, rules, regulations (see 28 CFR Part 35, 29 CFR Part 1630, 29 CFR Parts 1625-1627, 41 CFR Part 60 and 49 CFR Part 27) and orders of the Secretary of Labor as modified by the provisions prescribed herein, and imposed pursuant to 23 U.S.C. 140, shall constitute the EEO and specific affirmative action standards for the contractor's project activities under this contract. The provisions of the Americans with Disabilities Act of 1990 (42 U.S.C. 12101 et seq.) set forth under 28 CFR Part 35 and 29 CFR Part 1630 are incorporated by reference in this contract. In the execution of this contract, the contractor agrees to comply with the following minimum specific requirement activities of EEO:

a. The contractor will work with the contracting agency and the Federal Government to ensure that it has made every good faith effort to provide equal opportunity with respect to all of its terms and conditions of employment and in their review of activities under the contract. 23 CFR 230.409 (g)(4) & (5).

b. The contractor will accept as its operating policy the following statement:

"It is the policy of this Company to assure that applicants are employed, and that employees are treated during employment, without regard to their race, religion, sex, sexual orientation, gender identity, color, national origin, age or disability. Such action shall include: employment, upgrading, demotion, or transfer; recruitment or recruitment advertising; layoff or termination; rates of pay or other forms of compensation; and selection for training, including apprenticeship, pre-apprenticeship, and/or on-the-job training."

2. EEO Officer: The contractor will designate and make known to the contracting officers an EEO Officer who will have the responsibility for and must be capable of effectively administering and promoting an active EEO program and who must be assigned adequate authority and responsibility to do so.

3. Dissemination of Policy: All members of the contractor's staff who are authorized to hire, supervise, promote, and discharge employees, or who recommend such action or are substantially involved in such action, will be made fully cognizant of and will implement the contractor's EEO policy and contractual responsibilities to provide EEO in each grade and classification of employment. To ensure that the above agreement will be met, the following actions will be taken as a minimum:

a. Periodic meetings of supervisory and personnel office employees will be conducted before the start of work and then not less often than once every six months, at which time the contractor's EEO policy and its implementation will be reviewed and explained. The meetings will be conducted by the EEO Officer or other knowledgeable company official.

b. All new supervisory or personnel office employees will be given a thorough indoctrination by the EEO Officer, covering all major aspects of the contractor's EEO obligations within thirty days following their reporting for duty with the contractor.

c. All personnel who are engaged in direct recruitment for the project will be instructed by the EEO Officer in the contractor's procedures for locating and hiring minorities and women.

d. Notices and posters setting forth the contractor's EEO policy will be placed in areas readily accessible to employees, applicants for employment and potential employees.

e. The contractor's EEO policy and the procedures to implement such policy will be brought to the attention of employees by means of meetings, employee handbooks, or other appropriate means.

4. Recruitment: When advertising for employees, the contractor will include in all advertisements for employees the notation: "An Equal Opportunity Employer." All such advertisements will be placed in publications having a large circulation among minorities and women in the area from which the project work force would normally be derived.

a. The contractor will, unless precluded by a valid bargaining agreement, conduct systematic and direct recruitment through public and private employee referral sources likely to yield qualified minorities and women. To meet this requirement, the contractor will identify sources of potential minority group employees and establish with such identified sources procedures whereby minority and women applicants may be referred to the contractor for employment consideration.

b. In the event the contractor has a valid bargaining agreement providing for exclusive hiring hall referrals, the contractor is expected to observe the provisions of that agreement to the extent that the system meets the contractor's compliance with EEO contract provisions. Where implementation of such an agreement has the effect of discriminating against minorities or women, or obligates the contractor to do the same, such implementation violates Federal nondiscrimination provisions.

c. The contractor will encourage its present employees to refer minorities and women as applicants for employment. Information and procedures with regard to referring such applicants will be discussed with employees.

5. Personnel Actions: Wages, working conditions, and employee benefits shall be established and administered, and personnel actions of every type, including hiring, upgrading, promotion, transfer, demotion, layoff, and termination, shall be taken without regard to race, color, religion, sex, sexual orientation, gender identity, national origin, age or disability. The following procedures shall be followed:

a. The contractor will conduct periodic inspections of project sites to ensure that working conditions and employee facilities do not indicate discriminatory treatment of project site personnel.

b. The contractor will periodically evaluate the spread of wages paid within each classification to determine any evidence of discriminatory wage practices.

c. The contractor will periodically review selected personnel actions in depth to determine whether there is evidence of discrimination. Where evidence is found, the contractor will promptly take corrective action. If the review indicates that the discrimination may extend beyond the actions reviewed, such corrective action shall include all affected persons.

d. The contractor will promptly investigate all complaints of alleged discrimination made to the contractor in connection with its obligations under this contract, will attempt to resolve such complaints, and will take appropriate corrective action within a reasonable time. If the investigation indicates that the discrimination may affect persons other than the complainant, such corrective action shall include such other persons. Upon completion of each investigation, the contractor will inform every complainant of all of their avenues of appeal.

6. Training and Promotion:

a. The contractor will assist in locating, qualifying, and increasing the skills of minorities and women who are applicants for employment or current employees. Such efforts should be aimed at developing full journey level status employees in the type of trade or job classification involved.

b. Consistent with the contractor's work force requirements and as permissible under Federal and State regulations, the contractor shall make full use of training programs (i.e., apprenticeship and on-the-job training programs for the geographical area of contract performance). In the event a special provision for training is provided under this contract, this subparagraph will be superseded as indicated in the special provision. The contracting agency may reserve training positions for persons who receive welfare assistance in accordance with 23 U.S.C. 140(a).

c. The contractor will advise employees and applicants for employment of available training programs and entrance requirements for each.

d. The contractor will periodically review the training and promotion potential of employees who are minorities and women and will encourage eligible employees to apply for such training and promotion.

7. Unions: If the contractor relies in whole or in part upon unions as a source of employees, the contractor will use good faith efforts to obtain the cooperation of such unions to increase opportunities for minorities and women. 23 CFR 230.409. Actions by the contractor, either directly or through a contractor's association acting as agent, will include the procedures set forth below:

a. The contractor will use good faith efforts to develop, in cooperation with the unions, joint training programs aimed toward qualifying more minorities and women for membership in the unions and increasing the skills of minorities and women so that they may qualify for higher paying employment.

b. The contractor will use good faith efforts to incorporate an EEO clause into each union agreement to the end that such union will be contractually bound to refer applicants without regard to their race, color, religion, sex, sexual orientation, gender identity, national origin, age, or disability.

c. The contractor is to obtain information as to the referral practices and policies of the labor union except that to the extent such information is within the exclusive possession of the labor union and such labor union refuses to furnish such information to the contractor, the contractor shall so certify to the contracting agency and shall set forth what efforts have been made to obtain such information.

d. In the event the union is unable to provide the contractor with a reasonable flow of referrals within the time limit set forth in the collective bargaining agreement, the contractor will, through independent recruitment efforts, fill the employment vacancies without regard to race, color, religion, sex, sexual orientation, gender identity, national origin, age, or disability; making full efforts to obtain qualified and/or qualifiable minorities and women. The failure of a union to provide sufficient referrals (even though it is obligated to provide exclusive referrals under the terms of a collective bargaining agreement) does not relieve the contractor from the requirements of this paragraph. In the event the union referral practice prevents the contractor from meeting the obligations pursuant to Executive Order 11246, as amended, and these special provisions, such contractor shall immediately notify the contracting agency.

8. Reasonable Accommodation for Applicants / Employees with Disabilities:

The contractor must be familiar with the requirements for and comply with the Americans with Disabilities Act and all rules and regulations established thereunder. Employers must provide reasonable accommodation in all employment activities unless to do so would cause an undue hardship.

9. Selection of Subcontractors, Procurement of Materials and Leasing of Equipment:

The contractor shall not discriminate on the grounds of race, color, religion, sex, sexual orientation, gender identity, national origin, age, or disability in the selection and retention of subcontractors, including procurement of materials and leases of equipment. The contractor shall take all necessary and reasonable steps to ensure nondiscrimination in the administration of this contract.

a. The contractor shall notify all potential subcontractors, suppliers, and lessors of their EEO obligations under this contract.

b. The contractor will use good faith efforts to ensure subcontractor compliance with their EEO obligations.

10. Assurance Required:

a. The requirements of 49 CFR Part 26 and the State DOT's FHWA-approved Disadvantaged Business Enterprise (DBE) program are incorporated by reference.

b. The contractor, subrecipient or subcontractor shall not discriminate on the basis of race, color, national origin, or sex in the performance of this contract. The contractor shall carry out applicable requirements of 49 CFR part 26 in the award and administration of DOT-assisted contracts. Failure by the contractor to carry out these requirements is a material breach of this contract, which may result in the termination of this contract or such other remedy as the recipient deems appropriate, which may include, but is not limited to:

- (1) Withholding monthly progress payments;
- (2) Assessing sanctions;
- (3) Liquidated damages; and/or
- (4) Disqualifying the contractor from future bidding as non-responsible.

c. The Title VI and nondiscrimination provisions of U.S. DOT Order 1050.2A at Appendixes A and E are incorporated by reference. 49 CFR Part 21.

11. Records and Reports: The contractor shall keep such records as necessary to document compliance with the EEO requirements. Such records shall be retained for a period of three years following the date of the final payment to the contractor for all contract work and shall be available at reasonable times and places for inspection by authorized representatives of the contracting agency and the FHWA.

a. The records kept by the contractor shall document the following:

- (1) The number and work hours of minority and non-minority group members and women employed in each work classification on the project;
- (2) The progress and efforts being made in cooperation with unions, when applicable, to increase employment opportunities for minorities and women; and
- (3) The progress and efforts being made in locating, hiring, training, qualifying, and upgrading minorities and women.

b. The contractors and subcontractors will submit an annual report to the contracting agency each July for the duration of the project indicating the number of minority, women, and non-minority group employees currently engaged in each work classification required by the contract work. This information is to be reported on Form FHWA-1391. The staffing data should represent the project work force on board in all or any part of the last payroll period preceding the end of July. If on-the-job training is being required by special provision, the contractor will be required to collect and report training data. The employment data should reflect the work force on board during all or any part of the last payroll period preceding the end of July.

III. NONSEGREGATED FACILITIES

This provision is applicable to all Federal-aid construction contracts and to all related construction subcontracts of more than \$10,000. 41 CFR 60-1.5.

As prescribed by 41 CFR 60-1.8, the contractor must ensure that facilities provided for employees are provided in such a manner that segregation on the basis of race, color, religion, sex, sexual orientation, gender identity, or national origin cannot result. The contractor may neither require such segregated use by written or oral policies nor tolerate such use by employee custom. The contractor's obligation extends further to ensure that its employees are not assigned to perform their services at any location under the contractor's control where the facilities are segregated. The term "facilities" includes waiting rooms, work areas, restaurants and other eating areas, time clocks, restrooms, washrooms, locker rooms and other storage or dressing areas, parking lots, drinking fountains, recreation or entertainment areas, transportation, and housing provided for employees. The contractor shall provide separate or single-user restrooms and necessary dressing or sleeping areas to assure privacy between sexes.

IV. DAVIS-BACON AND RELATED ACT PROVISIONS

This section is applicable to all Federal-aid construction projects exceeding \$2,000 and to all related subcontracts and lower-tier subcontracts (regardless of subcontract size), in accordance with 29 CFR 5.5. The requirements apply to all projects located within the right-of-way of a roadway that is functionally classified as Federal-aid highway. 23 U.S.C. 113. This excludes roadways functionally classified as local roads or rural minor collectors, which are exempt. 23 U.S.C. 101. Where applicable law requires that projects be treated as a project on a Federal-aid highway, the provisions of this subpart will apply regardless of the location of the project. Examples include: Surface Transportation Block Grant Program projects funded under 23 U.S.C. 133 [excluding recreational trails projects], the Nationally Significant Freight and Highway Projects funded under 23 U.S.C. 117, and National Highway Freight Program projects funded under 23 U.S.C. 167.

The following provisions are from the U.S. Department of Labor regulations in 29 CFR 5.5 "Contract provisions and related matters" with minor revisions to conform to the FHWA-1273 format and FHWA program requirements.

1. Minimum wages (29 CFR 5.5)

a. All laborers and mechanics employed or working upon the site of the work, will be paid unconditionally and not less often than once a week, and without subsequent deduction or rebate on any account (except such payroll deductions as are permitted by regulations issued by the Secretary of Labor under the Copeland Act (29 CFR part 3)), the full amount of wages and bona fide fringe benefits (or cash equivalents thereof) due at time of payment computed at rates not less than those contained in the wage determination of the Secretary of Labor which is attached hereto and made a part hereof, regardless of any contractual relationship which may be alleged to exist between the contractor and such laborers and mechanics.

Contributions made or costs reasonably anticipated for bona fide fringe benefits under section 1(b)(2) of the Davis-Bacon Act on behalf of laborers or mechanics are considered wages paid to such laborers or mechanics, subject to the provisions of paragraph 1.d. of this section; also, regular contributions made or costs incurred for more than a weekly period (but not less often than quarterly) under plans, funds, or programs which cover the particular weekly period, are deemed to be constructively made or incurred during such weekly period. Such laborers and mechanics shall be paid the appropriate wage rate and fringe benefits on the wage determination for the classification of work actually performed, without regard to skill, except as provided in 29 CFR 5.5(a)(4). Laborers or mechanics performing work in more than one classification may be compensated at the rate specified for each classification for the time actually worked therein: Provided, That the employer's payroll records accurately set forth the time spent in each classification in which work is performed. The wage determination (including any additional classification and wage rates conformed under paragraph 1.b. of this section) and the Davis-Bacon poster (WH-1321) shall be posted at all times by the contractor and its subcontractors at the site of the work in a prominent and accessible place where it can be easily seen by the workers.

- b. (1) The contracting officer shall require that any class of laborers or mechanics, including helpers, which is not listed in the wage determination and which is to be employed under the contract shall be classified in conformance with the wage determination. The contracting officer shall approve an additional classification and wage rate and fringe benefits therefore only when the following criteria have been met:
- (i) The work to be performed by the classification requested is not performed by a classification in the wage determination; and
 - (ii) The classification is utilized in the area by the construction industry; and
 - (iii) The proposed wage rate, including any bona fide fringe benefits, bears a reasonable relationship to the wage rates contained in the wage determination.
- (2) If the contractor and the laborers and mechanics to be employed in the classification (if known), or their representatives, and the contracting officer agree on the classification and wage rate (including the amount designated for fringe benefits where appropriate), a report of the action taken shall be sent by the contracting officer to the Administrator of the Wage and Hour Division, U.S. Department of Labor, Washington, DC 20210. The Administrator, or an authorized representative, will approve, modify, or disapprove every additional classification action within 30 days of receipt and so advise the contracting officer or will notify the contracting officer within the 30-day period that additional time is necessary.

(3) In the event the contractor, the laborers or mechanics to be employed in the classification or their representatives, and the contracting officer do not agree on the proposed classification and wage rate (including the amount designated for fringe benefits, where appropriate), the contracting officer shall refer the questions, including the views of all interested parties and the recommendation of the contracting officer, to the Administrator for determination. The Administrator, or an authorized representative, will issue a determination within 30 days of receipt and so advise the contracting officer or will notify the contracting officer within the 30-day period that additional time is necessary.

(4) The wage rate (including fringe benefits where appropriate) determined pursuant to paragraphs 1.b.(2) or 1.b.(3) of this section, shall be paid to all workers performing work in the classification under this contract from the first day on which work is performed in the classification.

c. Whenever the minimum wage rate prescribed in the contract for a class of laborers or mechanics includes a fringe benefit which is not expressed as an hourly rate, the contractor shall either pay the benefit as stated in the wage determination or shall pay another bona fide fringe benefit or an hourly cash equivalent thereof.

d. If the contractor does not make payments to a trustee or other third person, the contractor may consider as part of the wages of any laborer or mechanic the amount of any costs reasonably anticipated in providing bona fide fringe benefits under a plan or program, Provided, That the Secretary of Labor has found, upon the written request of the contractor, that the applicable standards of the Davis-Bacon Act have been met. The Secretary of Labor may require the contractor to set aside in a separate account assets for the meeting of obligations under the plan or program.

2. Withholding (29 CFR 5.5)

The contracting agency shall upon its own action or upon written request of an authorized representative of the Department of Labor, withhold or cause to be withheld from the contractor under this contract, or any other Federal contract with the same prime contractor, or any other federally-assisted contract subject to Davis-Bacon prevailing wage requirements, which is held by the same prime contractor, so much of the accrued payments or advances as may be considered necessary to pay laborers and mechanics, including apprentices, trainees, and helpers, employed by the contractor or any subcontractor the full amount of wages required by the contract. In the event of failure to pay any laborer or mechanic, including any apprentice, trainee, or helper, employed or working on the site of the work, all or part of the wages required by the contract, the contracting agency may, after written notice to the contractor, take such action as may be necessary to cause the suspension of any further payment, advance, or guarantee of funds until such violations have ceased.

3. Payrolls and basic records (29 CFR 5.5)

a. Payrolls and basic records relating thereto shall be maintained by the contractor during the course of the work and preserved for a period of three years thereafter for all laborers and mechanics working at the site of the work. Such records shall contain the name, address, and social security number of each such worker, his or her correct classification, hourly rates of wages paid (including rates of contributions or costs anticipated for bona fide fringe benefits or cash equivalents thereof of the types described in section 1(b)(2)(B) of the Davis-Bacon Act), daily and weekly number of hours worked, deductions made and actual wages paid. Whenever the Secretary of Labor has found under 29 CFR 5.5(a)(1)(iv) that the wages of any laborer or mechanic include the amount of any costs reasonably anticipated in providing benefits under a plan or program described in section 1(b)(2)(B) of the Davis-Bacon Act, the contractor shall maintain records which show that the commitment to provide such benefits is enforceable, that the plan or program is financially responsible, and that the plan or program has been communicated in writing to the laborers or mechanics affected, and records which show the costs anticipated or the actual cost incurred in providing such benefits. Contractors employing apprentices or trainees under approved programs shall maintain written evidence of the registration of apprenticeship programs and certification of trainee programs, the registration of the apprentices and trainees, and the ratios and wage rates prescribed in the applicable programs.

b. (1) The contractor shall submit weekly for each week in which any contract work is performed a copy of all payrolls to the contracting agency. The payrolls submitted shall set out accurately and completely all of the information required to be maintained under 29 CFR 5.5(a)(3)(i), except that full social security numbers and home addresses shall not be included on weekly transmittals. Instead the payrolls shall only need to include an individually identifying number for each employee (e.g., the last four digits of the employee's social security number). The required weekly payroll information may be submitted in any form desired. Optional Form WH-347 is available for this purpose from the Wage and Hour Division Web site. The prime contractor is responsible for the submission of copies of payrolls by all subcontractors. Contractors and subcontractors shall maintain the full social security number and current address of each covered worker, and shall provide them upon request to the contracting agency for transmission to the State DOT, the FHWA or the Wage and Hour Division of the Department of Labor for purposes of an investigation or audit of compliance with prevailing wage requirements. It is not a violation of this section for a prime contractor to require a subcontractor to provide addresses and social security numbers to the prime contractor for its own records, without weekly submission to the contracting agency.

(2) Each payroll submitted shall be accompanied by a "Statement of Compliance," signed by the contractor or subcontractor or his or her agent who pays or supervises the payment of the persons employed under the contract and shall certify the following:

(i) That the payroll for the payroll period contains the information required to be provided under 29 CFR 5.5(a)(3)(ii), the appropriate information is being maintained under 29 CFR 5.5(a)(3)(i), and that such information is correct and complete;

(ii) That each laborer or mechanic (including each helper, apprentice, and trainee) employed on the contract during the payroll period has been paid the full weekly wages earned, without rebate, either directly or indirectly, and that no deductions have been made either directly or indirectly from the full wages earned, other than permissible deductions as set forth in 29 CFR part 3;

(iii) That each laborer or mechanic has been paid not less than the applicable wage rates and fringe benefits or cash equivalents for the classification of work performed, as specified in the applicable wage determination incorporated into the contract.

(3) The weekly submission of a properly executed certification set forth on the reverse side of Optional Form WH-347 shall satisfy the requirement for submission of the "Statement of Compliance" required by paragraph 3.b.(2) of this section.

(4) The falsification of any of the above certifications may subject the contractor or subcontractor to civil or criminal prosecution under 18 U.S.C. 1001 and 31 U.S.C. 231.

c. The contractor or subcontractor shall make the records required under paragraph 3.a. of this section available for inspection, copying, or transcription by authorized representatives of the contracting agency, the State DOT, the FHWA, or the Department of Labor, and shall permit such representatives to interview employees during working hours on the job. If the contractor or subcontractor fails to submit the required records or to make them available, the FHWA may, after written notice to the contractor, the contracting agency or the State DOT, take such action as may be necessary to cause the suspension of any further payment, advance, or guarantee of funds. Furthermore, failure to submit the required records upon request or to make such records available may be grounds for debarment action pursuant to 29 CFR 5.12.

4. Apprentices and trainees (29 CFR 5.5)

a. Apprentices (programs of the USDOL).

Apprentices will be permitted to work at less than the predetermined rate for the work they performed when they are employed pursuant to and individually registered in a bona fide apprenticeship program registered with the U.S. Department of Labor, Employment and Training Administration, Office of Apprenticeship Training, Employer and Labor Services, or with a State Apprenticeship Agency recognized by the Office, or if a person is employed in his or her first 90 days of probationary employment as an apprentice in such an apprenticeship program, who is not individually registered in the program, but who has been certified by the Office of Apprenticeship Training, Employer and Labor Services or a State Apprenticeship Agency (where appropriate) to be eligible for probationary employment as an apprentice.

The allowable ratio of apprentices to journeymen on the job site in any craft classification shall not be greater than the ratio permitted to the contractor as to the entire work force under the registered program. Any worker listed on a payroll at an apprentice wage rate, who is not registered or otherwise employed as stated above, shall be paid not less than the applicable wage rate on the wage determination for the classification of work actually performed. In addition, any apprentice performing work on the job site in excess of the ratio permitted under the registered program shall be paid not less than the applicable wage rate on the wage determination for the work actually performed. Where a contractor is performing construction on a project in a locality other than that in which its program is registered, the ratios and wage rates (expressed in percentages of the journeyman's hourly rate) specified in the contractor's or subcontractor's registered program shall be observed.

Every apprentice must be paid at not less than the rate specified in the registered program for the apprentice's level of progress, expressed as a percentage of the journeyman hourly rate specified in the applicable wage determination. Apprentices shall be paid fringe benefits in accordance with the provisions of the apprenticeship program. If the apprenticeship program does not specify fringe benefits, apprentices must be paid the full amount of fringe benefits listed on the wage determination for the applicable classification. If the Administrator determines that a different practice prevails for the applicable apprentice classification, fringes shall be paid in accordance with that determination.

In the event the Office of Apprenticeship Training, Employer and Labor Services, or a State Apprenticeship Agency recognized by the Office, withdraws approval of an apprenticeship program, the contractor will no longer be permitted to utilize apprentices at less than the applicable predetermined rate for the work performed until an acceptable program is approved.

b. Trainees (programs of the USDOL).

Except as provided in 29 CFR 5.16, trainees will not be permitted to work at less than the predetermined rate for the work performed unless they are employed pursuant to and individually registered in a program which has received prior approval, evidenced by formal certification by the U.S. Department of Labor, Employment and Training Administration.

The ratio of trainees to journeymen on the job site shall not be greater than permitted under the plan approved by the Employment and Training Administration.

Every trainee must be paid at not less than the rate specified in the approved program for the trainee's level of progress, expressed as a percentage of the journeyman hourly rate specified in the applicable wage determination. Trainees shall be paid fringe benefits in accordance with the provisions of the trainee program. If the trainee program does not mention fringe benefits, trainees shall be paid the full amount of fringe benefits listed on the wage determination unless the Administrator of the Wage and Hour Division determines that there is an apprenticeship program associated with the corresponding journeyman wage rate on the wage determination which provides for less than full fringe benefits for apprentices. Any employee listed on the payroll at a trainee rate who is not registered and participating in a training plan approved by the Employment and Training Administration shall be paid not less than the applicable wage rate on the wage determination for the classification of work actually performed. In addition, any trainee performing work on the job site in excess of the ratio permitted under the registered program shall be paid not less than the applicable wage rate on the wage determination for the work actually performed.

In the event the Employment and Training Administration withdraws approval of a training program, the contractor will no longer be permitted to utilize trainees at less than the applicable predetermined rate for the work performed until an acceptable program is approved.

c. Equal employment opportunity. The utilization of apprentices, trainees and journeymen under this part shall be in conformity with the equal employment opportunity requirements of Executive Order 11246, as amended, and 29 CFR part 30.

d. Apprentices and Trainees (programs of the U.S. DOT).

Apprentices and trainees working under apprenticeship and skill training programs which have been certified by the Secretary of Transportation as promoting EEO in connection with Federal-aid highway construction programs are not subject to the requirements of paragraph 4 of this Section IV. 23 CFR 230.111(e)(2). The straight time hourly wage rates for apprentices and trainees under such programs will be established by the particular programs. The ratio of apprentices and trainees to journeymen shall not be greater than permitted by the terms of the particular program.

5. Compliance with Copeland Act requirements. The contractor shall comply with the requirements of 29 CFR part 3, which are incorporated by reference in this contract as provided in 29 CFR 5.5.

6. Subcontracts. The contractor or subcontractor shall insert Form FHWA-1273 in any subcontracts and also require the subcontractors to include Form FHWA-1273 in any lower tier subcontracts. The prime contractor shall be responsible for the compliance by any subcontractor or lower tier subcontractor with all the contract clauses in 29 CFR 5.5.

7. Contract termination: debarment. A breach of the contract clauses in 29 CFR 5.5 may be grounds for termination of the contract, and for debarment as a contractor and a subcontractor as provided in 29 CFR 5.12.

8. Compliance with Davis-Bacon and Related Act requirements. All rulings and interpretations of the Davis-Bacon and Related Acts contained in 29 CFR parts 1, 3, and 5 are herein incorporated by reference in this contract as provided in 29 CFR 5.5.

9. Disputes concerning labor standards. As provided in 29 CFR 5.5, disputes arising out of the labor standards provisions of this contract shall not be subject to the general disputes clause of this contract. Such disputes shall be resolved in accordance with the procedures of the Department of Labor set forth in 29 CFR parts 5, 6, and 7. Disputes within the meaning of this clause include disputes between the contractor (or any of its subcontractors) and the contracting agency, the U.S. Department of Labor, or the employees or their representatives.

10. Certification of eligibility (29 CFR 5.5)

a. By entering into this contract, the contractor certifies that neither it (nor he or she) nor any person or firm who has an interest in the contractor's firm is a person or firm ineligible to be awarded Government contracts by virtue of section 3(a) of the Davis-Bacon Act or 29 CFR 5.12(a)(1).

b. No part of this contract shall be subcontracted to any person or firm ineligible for award of a Government contract by virtue of section 3(a) of the Davis-Bacon Act or 29 CFR 5.12(a)(1).

c. The penalty for making false statements is prescribed in the U.S. Criminal Code, 18 U.S.C. 1001.

V. CONTRACT WORK HOURS AND SAFETY STANDARDS ACT

Pursuant to 29 CFR 5.5(b), the following clauses apply to any Federal-aid construction contract in an amount in excess of \$100,000 and subject to the overtime provisions of the Contract Work Hours and Safety Standards Act. These clauses shall be inserted in addition to the clauses required by 29 CFR 5.5(a) or 29 CFR 4.6. As used in this paragraph, the terms laborers and mechanics include watchmen and guards.

1. Overtime requirements. No contractor or subcontractor contracting for any part of the contract work which may require or involve the employment of laborers or mechanics shall require or permit any such laborer or mechanic in any workweek in which he or she is employed on such work to work in excess of forty hours in such workweek unless such laborer or mechanic receives compensation at a rate not less than one and one-half times the basic rate of pay for all hours worked in excess of forty hours in such workweek. 29 CFR 5.5.

2. Violation; liability for unpaid wages; liquidated damages. In the event of any violation of the clause set forth in paragraph 1 of this section, the contractor and any subcontractor responsible therefor shall be liable for the unpaid wages. In addition, such contractor and subcontractor shall be liable to the United States (in the case of work done under contract for the District of Columbia or a territory, to such District or to such territory), for liquidated damages. Such liquidated damages shall be computed with respect to each individual laborer or mechanic, including watchmen and guards, employed in violation of the clause set forth in paragraph 1 of this section, in the sum currently provided in 29 CFR 5.5(b)(2)* for each calendar day on which such individual was required or permitted to work in excess of the standard workweek of forty hours without payment of the overtime wages required by the clause set forth in paragraph 1 of this section. 29 CFR 5.5.

* \$27 as of January 23, 2019 (See 84 FR 213-01, 218) as may be adjusted annually by the Department of Labor; pursuant to the Federal Civil Penalties Inflation Adjustment Act of 1990).

3. Withholding for unpaid wages and liquidated damages. The FHWA or the contracting agency shall upon its own action or upon written request of an authorized representative of the Department of Labor withhold or cause to be withheld, from any moneys payable on account of work performed by the contractor or subcontractor under any such contract or any other Federal contract with the same prime contractor, or any other federally-assisted contract subject to the Contract Work Hours and Safety Standards Act, which is held by the same prime contractor, such sums as may be determined to be necessary to satisfy any liabilities of such contractor or subcontractor for unpaid wages and liquidated damages as provided in the clause set forth in paragraph 2 of this section. 29 CFR 5.5.

4. Subcontracts. The contractor or subcontractor shall insert in any subcontracts the clauses set forth in paragraphs 1 through 4 of this section and also a clause requiring the subcontractors to include these clauses in any lower tier subcontracts. The prime contractor shall be responsible for compliance by any subcontractor or lower tier subcontractor with the clauses set forth in paragraphs 1 through 4 of this section. 29 CFR 5.5.

VI. SUBLETTING OR ASSIGNING THE CONTRACT

This provision is applicable to all Federal-aid construction contracts on the National Highway System pursuant to 23 CFR 635.116.

1. The contractor shall perform with its own organization contract work amounting to not less than 30 percent (or a greater percentage if specified elsewhere in the contract) of the total original contract price, excluding any specialty items designated by the contracting agency. Specialty items may be performed by subcontract and the amount of any such specialty items performed may be deducted from the total original contract price before computing the amount of work required to be performed by the contractor's own organization (23 CFR 635.116).

a. The term "perform work with its own organization" in paragraph 1 of Section VI refers to workers employed or leased by the prime contractor, and equipment owned or rented by the prime contractor, with or without operators. Such term does not include employees or equipment of a subcontractor or lower tier subcontractor, agents of the prime contractor, or any other assignees. The term may include payments for the costs of hiring leased employees from an employee leasing firm meeting all relevant Federal and State regulatory requirements. Leased employees may only be included in this term if the prime contractor meets all of the following conditions: (based on longstanding interpretation)

(1) the prime contractor maintains control over the supervision of the day-to-day activities of the leased employees;

(2) the prime contractor remains responsible for the quality of the work of the leased employees;

(3) the prime contractor retains all power to accept or exclude individual employees from work on the project; and

(4) the prime contractor remains ultimately responsible for the payment of predetermined minimum wages, the submission of payrolls, statements of compliance and all other Federal regulatory requirements.

b. "Specialty Items" shall be construed to be limited to work that requires highly specialized knowledge, abilities, or equipment not ordinarily available in the type of contracting organizations qualified and expected to bid or propose on the contract as a whole and in general are to be limited to minor components of the overall contract. 23 CFR 635.102.

2. Pursuant to 23 CFR 635.116(a), the contract amount upon which the requirements set forth in paragraph (1) of Section VI is computed includes the cost of material and manufactured products which are to be purchased or produced by the contractor under the contract provisions.

3. Pursuant to 23 CFR 635.116(c), the contractor shall furnish (a) a competent superintendent or supervisor who is employed by the firm, has full authority to direct performance of the work in accordance with the contract requirements, and is in charge of all construction operations (regardless of who performs the work) and (b) such other of its own organizational resources (supervision, management, and engineering services) as the contracting officer determines is necessary to assure the performance of the contract.

4. No portion of the contract shall be sublet, assigned or otherwise disposed of except with the written consent of the contracting officer, or authorized representative, and such consent when given shall not be construed to relieve the contractor of any responsibility for the fulfillment of the contract. Written consent will be given only after the contracting agency has assured that each subcontract is evidenced in writing and that it contains all pertinent provisions and requirements of the prime contract. (based on long-standing interpretation of 23 CFR 635.116).

5. The 30-percent self-performance requirement of paragraph (1) is not applicable to design-build contracts; however, contracting agencies may establish their own self-performance requirements. 23 CFR 635.116(d).

VII. SAFETY: ACCIDENT PREVENTION

This provision is applicable to all Federal-aid construction contracts and to all related subcontracts.

1. In the performance of this contract the contractor shall comply with all applicable Federal, State, and local laws governing safety, health, and sanitation (23 CFR Part 635). The contractor shall provide all safeguards, safety devices and protective equipment and take any other needed actions as it determines, or as the contracting officer may determine, to be reasonably necessary to protect the life and health of employees on the job and the safety of the public and to protect property in connection with the performance of the work covered by the contract. 23 CFR 635.108.

2. It is a condition of this contract, and shall be made a condition of each subcontract, which the contractor enters into pursuant to this contract, that the contractor and any subcontractor shall not permit any employee, in performance of the contract, to work in surroundings or under conditions which are unsanitary, hazardous or dangerous to his/her health or safety, as determined under construction safety and health standards (29 CFR Part 1926) promulgated by the Secretary of Labor, in accordance with Section 107 of the Contract Work Hours and Safety Standards Act (40 U.S.C. 3704). 29 CFR 1926.10.

3. Pursuant to 29 CFR 1926.3, it is a condition of this contract that the Secretary of Labor or authorized representative thereof, shall have right of entry to any site of contract performance to inspect or investigate the matter of compliance with the construction safety and health standards and to carry out the duties of the Secretary under Section 107 of the Contract Work Hours and Safety Standards Act (40 U.S.C. 3704).

VIII. FALSE STATEMENTS CONCERNING HIGHWAY PROJECTS

This provision is applicable to all Federal-aid construction contracts and to all related subcontracts.

In order to assure high quality and durable construction in conformity with approved plans and specifications and a high degree of reliability on statements and representations made by engineers, contractors, suppliers, and workers on Federal-aid highway projects, it is essential that all persons concerned with the project perform their functions as carefully, thoroughly, and honestly as possible. Willful falsification, distortion, or misrepresentation with respect to any facts related to the project is a violation of Federal law. To prevent any misunderstanding regarding the seriousness of these and similar acts, Form FHWA-1022 shall be posted on each Federal-aid highway project (23 CFR Part 635) in one or more places where it is readily available to all persons concerned with the project:

18 U.S.C. 1020 reads as follows:

"Whoever, being an officer, agent, or employee of the United States, or of any State or Territory, or whoever, whether a person, association, firm, or corporation, knowingly makes any false statement, false representation, or false report as to the character, quality, quantity, or cost of the material used or to be used, or the quantity or quality of the work performed or to be performed, or the cost thereof in connection with the submission of plans, maps, specifications, contracts, or costs of construction on any highway or related project submitted for approval to the Secretary of Transportation; or

Whoever knowingly makes any false statement, false representation, false report or false claim with respect to the character, quality, quantity, or cost of any work performed or to be performed, or materials furnished or to be furnished, in connection with the construction of any highway or related project approved by the Secretary of Transportation; or

Whoever knowingly makes any false statement or false representation as to material fact in any statement, certificate, or report submitted pursuant to provisions of the Federal-aid Roads Act approved July 11, 1916, (39 Stat. 355), as amended and supplemented;

Shall be fined under this title or imprisoned not more than 5 years or both."

IX. IMPLEMENTATION OF CLEAN AIR ACT AND FEDERAL WATER POLLUTION CONTROL ACT (42 U.S.C. 7606; 2 CFR 200.88; EO 11738)

This provision is applicable to all Federal-aid construction contracts in excess of \$150,000 and to all related subcontracts. 48 CFR 2.101; 2 CFR 200.326.

By submission of this bid/proposal or the execution of this contract or subcontract, as appropriate, the bidder, proposer, Federal-aid construction contractor, subcontractor, supplier, or vendor agrees to comply with all applicable standards, orders or regulations issued pursuant to the Clean Air Act (42 U.S.C. 7401-7671q) and the Federal Water Pollution Control Act, as amended (33 U.S.C. 1251-1387). Violations must be reported to the Federal Highway Administration and the Regional Office of the Environmental Protection Agency. 2 CFR Part 200, Appendix II.

The contractor agrees to include or cause to be included the requirements of this Section in every subcontract, and further agrees to take such action as the contracting agency may direct as a means of enforcing such requirements. 2 CFR 200.326.

X. CERTIFICATION REGARDING DEBARMENT, SUSPENSION, INELIGIBILITY AND VOLUNTARY EXCLUSION

This provision is applicable to all Federal-aid construction contracts, design-build contracts, subcontracts, lower-tier subcontracts, purchase orders, lease agreements, consultant contracts or any other covered transaction requiring FHWA approval or that is estimated to cost \$25,000 or more – as defined in 2 CFR Parts 180 and 1200. 2 CFR 180.220 and 1200.220.

1. Instructions for Certification – First Tier Participants:

a. By signing and submitting this proposal, the prospective first tier participant is providing the certification set out below.

b. The inability of a person to provide the certification set out below will not necessarily result in denial of participation in this covered transaction. The prospective first tier participant shall submit an explanation of why it cannot provide the certification set out below. The certification or explanation will be considered in connection with the department or agency's determination whether to enter into this transaction. However, failure of the prospective first tier participant to furnish a certification or an explanation shall disqualify such a person from participation in this transaction. 2 CFR 180.320.

c. The certification in this clause is a material representation of fact upon which reliance was placed when the contracting agency determined to enter into this transaction. If it is later determined that the prospective participant knowingly rendered an erroneous certification, in addition to other remedies available to the Federal Government, the contracting agency may terminate this transaction for cause of default. 2 CFR 180.325.

d. The prospective first tier participant shall provide immediate written notice to the contracting agency to whom this proposal is submitted if any time the prospective first tier participant learns that its certification was erroneous when submitted or has become erroneous by reason of changed circumstances. 2 CFR 180.345 and 180.350.

e. The terms "covered transaction," "debarred," "suspended," "ineligible," "participant," "person," "principal," and "voluntarily excluded," as used in this clause, are defined in 2 CFR Parts 180, Subpart I, 180.900-180.1020, and 1200. "First Tier Covered Transactions" refers to any covered transaction between a recipient or subrecipient of Federal funds and a participant (such as the prime or general contract). "Lower Tier Covered Transactions" refers to any covered transaction under a First Tier Covered Transaction (such as subcontracts). "First Tier Participant" refers to the participant who has entered into a covered transaction with a recipient or subrecipient of Federal funds (such as the prime or general contractor). "Lower Tier Participant" refers any participant who has entered into a covered transaction with a First Tier Participant or other Lower Tier Participants (such as subcontractors and suppliers).

f. The prospective first tier participant agrees by submitting this proposal that, should the proposed covered transaction be entered into, it shall not knowingly enter into any lower tier covered transaction with a person who is debarred, suspended, declared ineligible, or voluntarily excluded from participation in this covered transaction, unless authorized by the department or agency entering into this transaction. 2 CFR 180.330.

g. The prospective first tier participant further agrees by submitting this proposal that it will include the clause titled "Certification Regarding Debarment, Suspension, Ineligibility and Voluntary Exclusion-Lower Tier Covered Transactions," provided by the department or contracting agency, entering into this covered transaction, without modification, in all lower tier covered transactions and in all solicitations for lower tier covered transactions exceeding the \$25,000 threshold. 2 CFR 180.220 and 180.300.

h. A participant in a covered transaction may rely upon a certification of a prospective participant in a lower tier covered transaction that is not debarred, suspended, ineligible, or voluntarily excluded from the covered transaction, unless it knows that the certification is erroneous. 2 CFR 180.300; 180.320, and 180.325. A participant is responsible for ensuring that its principals are not suspended, debarred, or otherwise ineligible to participate in covered transactions. 2 CFR 180.335. To verify the eligibility of its principals, as well as the eligibility of any lower tier prospective participants, each participant may, but is not required to, check the System for Award Management website (<https://www.sam.gov>). 2 CFR 180.300, 180.320, and 180.325.

i. Nothing contained in the foregoing shall be construed to require the establishment of a system of records in order to render in good faith the certification required by this clause. The knowledge and information of the prospective participant is not required to exceed that which is normally possessed by a prudent person in the ordinary course of business dealings.

j. Except for transactions authorized under paragraph (f) of these instructions, if a participant in a covered transaction knowingly enters into a lower tier covered transaction with a person who is suspended, debarred, ineligible, or voluntarily excluded from participation in this transaction, in addition to other remedies available to the Federal Government, the department or agency may terminate this transaction for cause or default. 2 CFR 180.325.

* * * * *

2. Certification Regarding Debarment, Suspension, Ineligibility and Voluntary Exclusion – First Tier Participants:

a. The prospective first tier participant certifies to the best of its knowledge and belief, that it and its principals:

(1) Are not presently debarred, suspended, proposed for debarment, declared ineligible, or voluntarily excluded from participating in covered transactions by any Federal department or agency, 2 CFR 180.335;

(2) Have not within a three-year period preceding this proposal been convicted of or had a civil judgment rendered against them for commission of fraud or a criminal offense in connection with obtaining, attempting to obtain, or performing a public (Federal, State, or local) transaction or contract under a public transaction; violation of Federal or State antitrust statutes or commission of embezzlement, theft, forgery, bribery, falsification or destruction of records, making false statements, or receiving stolen property, 2 CFR 180.800;

(3) Are not presently indicted for or otherwise criminally or civilly charged by a governmental entity (Federal, State or local) with commission of any of the offenses enumerated in paragraph (a)(2) of this certification, 2 CFR 180.700 and 180.800; and

(4) Have not within a three-year period preceding this application/proposal had one or more public transactions (Federal, State or local) terminated for cause or default. 2 CFR 180.335(d).

(5) Are not a corporation that has been convicted of a felony violation under any Federal law within the two-year period preceding this proposal (USDOT Order 4200.6 implementing appropriations act requirements); and

(6) Are not a corporation with any unpaid Federal tax liability that has been assessed, for which all judicial and administrative remedies have been exhausted, or have lapsed, and that is not being paid in a timely manner pursuant to an agreement with the authority responsible for collecting the tax liability (USDOT Order 4200.6 implementing appropriations act requirements).

b. Where the prospective participant is unable to certify to any of the statements in this certification, such prospective participant should attach an explanation to this proposal. 2 CFR 180.335 and 180.340.

3. Instructions for Certification - Lower Tier Participants:

(Applicable to all subcontracts, purchase orders, and other lower tier transactions requiring prior FHWA approval or estimated to cost \$25,000 or more - 2 CFR Parts 180 and 1200). 2 CFR 180.220 and 1200.220.

a. By signing and submitting this proposal, the prospective lower tier participant is providing the certification set out below.

b. The certification in this clause is a material representation of fact upon which reliance was placed when this transaction was entered into. If it is later determined that the prospective lower tier participant knowingly rendered an erroneous certification, in addition to other remedies available to the Federal Government, the department, or agency with which this transaction originated may pursue available remedies, including suspension and/or debarment.

c. The prospective lower tier participant shall provide immediate written notice to the person to which this proposal is submitted if at any time the prospective lower tier participant learns that its certification was erroneous by reason of changed circumstances. 2 CFR 180.365.

d. The terms "covered transaction," "debarred," "suspended," "ineligible," "participant," "person," "principal," and "voluntarily excluded," as used in this clause, are defined in 2 CFR Parts 180, Subpart I, 180.900 – 180.1020, and 1200. You may contact the person to which this proposal is submitted for assistance in obtaining a copy of those regulations. "First Tier Covered Transactions" refers to any covered transaction between a recipient or subrecipient of Federal funds and a participant (such as the prime or general contract). "Lower Tier Covered Transactions" refers to any covered transaction under a First Tier Covered Transaction (such as subcontracts). "First Tier Participant" refers to the participant who has entered into a covered transaction with a recipient or subrecipient of Federal funds (such as the prime or general contractor). "Lower Tier Participant" refers any participant who has entered into a covered transaction with a First Tier Participant or other Lower Tier Participants (such as subcontractors and suppliers).

e. The prospective lower tier participant agrees by submitting this proposal that, should the proposed covered transaction be entered into, it shall not knowingly enter into any lower tier covered transaction with a person who is debarred, suspended, declared ineligible, or voluntarily excluded from participation in this covered transaction, unless authorized by the department or agency with which this transaction originated. 2 CFR 1200.220 and 1200.332.

f. The prospective lower tier participant further agrees by submitting this proposal that it will include this clause titled "Certification Regarding Debarment, Suspension, Ineligibility and Voluntary Exclusion-Lower Tier Covered Transaction," without modification, in all lower tier covered transactions and in all solicitations for lower tier covered transactions exceeding the \$25,000 threshold. 2 CFR 180.220 and 1200.220.

g. A participant in a covered transaction may rely upon a certification of a prospective participant in a lower tier covered transaction that is not debarred, suspended, ineligible, or voluntarily excluded from the covered transaction, unless it knows that the certification is erroneous. A participant is responsible for ensuring that its principals are not suspended, debarred, or otherwise ineligible to participate in covered transactions. To verify the eligibility of its principals, as well as the eligibility of any lower tier prospective participants, each participant may, but is not required to, check the System for Award Management website (<https://www.sam.gov/>), which is compiled by the General Services Administration. 2 CFR 180.300, 180.320, 180.330, and 180.335.

h. Nothing contained in the foregoing shall be construed to require establishment of a system of records in order to render in good faith the certification required by this clause. The knowledge and information of participant is not required to exceed that which is normally possessed by a prudent person in the ordinary course of business dealings.

i. Except for transactions authorized under paragraph e of these instructions, if a participant in a covered transaction knowingly enters into a lower tier covered transaction with a person who is suspended, debarred, ineligible, or voluntarily excluded from participation in this transaction, in addition to other remedies available to the Federal Government, the department or agency with which this transaction originated may pursue available remedies, including suspension and/or debarment. 2 CFR 180.325.

* * * * *

Certification Regarding Debarment, Suspension, Ineligibility and Voluntary Exclusion--Lower Tier Participants:

1. The prospective lower tier participant certifies, by submission of this proposal, that neither it nor its principals:

(a) is presently debarred, suspended, proposed for debarment, declared ineligible, or voluntarily excluded from participating in covered transactions by any Federal department or agency, 2 CFR 180.355;

(b) is a corporation that has been convicted of a felony violation under any Federal law within the two-year period preceding this proposal (USDOT Order 4200.6 implementing appropriations act requirements); and

(c) is a corporation with any unpaid Federal tax liability that has been assessed, for which all judicial and administrative remedies have been exhausted, or have lapsed, and that is not being paid in a timely manner pursuant to an agreement with the authority responsible for collecting the tax liability. (USDOT Order 4200.6 implementing appropriations act requirements)

2. Where the prospective lower tier participant is unable to certify to any of the statements in this certification, such prospective participant should attach an explanation to this proposal.

* * * * *

XI. CERTIFICATION REGARDING USE OF CONTRACT FUNDS FOR LOBBYING

This provision is applicable to all Federal-aid construction contracts and to all related subcontracts which exceed \$100,000. 49 CFR Part 20, App. A.

1. The prospective participant certifies, by signing and submitting this bid or proposal, to the best of his or her knowledge and belief, that:

a. No Federal appropriated funds have been paid or will be paid, by or on behalf of the undersigned, to any person for influencing or attempting to influence an officer or employee of any Federal agency, a Member of Congress, an officer or employee of Congress, or an employee of a Member of Congress in connection with the awarding of any Federal contract, the making of any Federal grant, the making of any Federal loan, the entering into of any cooperative agreement, and the extension, continuation, renewal, amendment, or modification of any Federal contract, grant, loan, or cooperative agreement.

b. If any funds other than Federal appropriated funds have been paid or will be paid to any person for influencing or attempting to influence an officer or employee of any Federal agency, a Member of Congress, an officer or employee of Congress, or an employee of a Member of Congress in connection with this Federal contract, grant, loan, or cooperative agreement, the undersigned shall complete and submit Standard Form-LLL, "Disclosure Form to Report Lobbying," in accordance with its instructions.

2. This certification is a material representation of fact upon which reliance was placed when this transaction was made or entered into. Submission of this certification is a prerequisite for making or entering into this transaction imposed by 31 U.S.C. 1352. Any person who fails to file the required certification shall be subject to a civil penalty of not less than \$10,000 and not more than \$100,000 for each such failure.

3. The prospective participant also agrees by submitting its bid or proposal that the participant shall require that the language of this certification be included in all lower tier subcontracts, which exceed \$100,000 and that all such recipients shall certify and disclose accordingly.

XII. USE OF UNITED STATES-FLAG VESSELS:

This provision is applicable to all Federal-aid construction contracts, design-build contracts, subcontracts, lower-tier subcontracts, purchase orders, lease agreements, or any other covered transaction. 46 CFR Part 381.

This requirement applies to material or equipment that is acquired for a specific Federal-aid highway project. 46 CFR 381.7. It is not applicable to goods or materials that come into inventories independent of an FHWA funded-contract.

When oceanic shipments (or shipments across the Great Lakes) are necessary for materials or equipment acquired for a specific Federal-aid construction project, the bidder, proposer, contractor, subcontractor, or vendor agrees:

1. To utilize privately owned United States-flag commercial vessels to ship at least 50 percent of the gross tonnage (computed separately for dry bulk carriers, dry cargo liners, and tankers) involved, whenever shipping any equipment, material, or commodities pursuant to this contract, to the extent such vessels are available at fair and reasonable rates for United States-flag commercial vessels. 46 CFR 381.7.

2. To furnish within 20 days following the date of loading for shipments originating within the United States or within 30 working days following the date of loading for shipments originating outside the United States, a legible copy of a rated, 'on-board' commercial ocean bill-of-lading in English for each shipment of cargo described in paragraph (b)(1) of this section to both the Contracting Officer (through the prime contractor in the case of subcontractor bills-of-lading) and to the Office of Cargo and Commercial Sealift (MAR-620), Maritime Administration, Washington, DC 20590. (MARAD requires copies of the ocean carrier's (master) bills of lading, certified onboard, dated, with rates and charges. These bills of lading may contain business sensitive information and therefore may be submitted directly to MARAD by the Ocean Transportation Intermediary on behalf of the contractor). 46 CFR 381.7.

12. FEMALE AND MINORITY GOALS

To comply with Section II, "Nondiscrimination," of "Required Contract Provisions Federal-Aid Construction Contracts," the following are for female and minority utilization goals for Federal-aid construction contracts and subcontracts that exceed \$10,000:

The nationwide goal for female utilization is 6.9 percent.

The goals for minority utilization (45 Fed Reg 65984 (10/3/1980)) are as follows:

MINORITY UTILIZATION GOALS

	Economic Area	Goal (Percent)
174	Redding CA: Non-SMSA (Standard Metropolitan Statistical Area) Counties: CA Lassen; CA Modoc; CA Plumas; CA Shasta; CA Siskiyou; CA Tehama	6.8
175	Eureka, CA Non-SMSA Counties: CA Del Norte; CA Humboldt; CA Trinity	6.6
176	San Francisco-Oakland-San Jose, CA: SMSA Counties: 7120 Salinas-Seaside-Monterey, CA CA Monterey	28.9
	7360 San Francisco-Oakland CA Alameda; CA Contra Costa; CA Marin; CA San Francisco; CA San Mateo	25.6
	7400 San Jose, CA	19.6
	CA Santa Clara, CA 7485 Santa Cruz, CA CA Santa Cruz	14.9
	7500 Santa Rosa CA Sonoma	9.1
	8720 Vallejo-Fairfield-Napa, CA CA Napa; CA Solano	17.1
	Non-SMSA Counties: CA Lake; CA Mendocino; CA San Benito	23.2
177	Sacramento, CA: SMSA Counties: 6920 Sacramento, CA CA Placer; CA Sacramento; CA Yolo Non-SMSA Counties	16.1
	CA Butte; CA Colusa; CA El Dorado; CA Glenn; CA Nevada; CA Sierra; CA Sutter; CA Yuba	14.3
178	Stockton-Modesto, CA: SMSA Counties: 5170 Modesto, CA CA Stanislaus	12.3
	8120 Stockton, CA CA San Joaquin	24.3
	Non-SMSA Counties CA Alpine; CA Amador; CA Calaveras; CA Mariposa; CA Merced; CA Tuolumne	19.8
179	Fresno-Bakersfield, CA SMSA Counties: 0680 Bakersfield, CA CA Kern	19.1
	2840 Fresno, CA	26.1

	CA Fresno Non-SMSA Counties: CA Kings; CA Madera; CA Tulare	23.6
180	Los Angeles, CA: SMSA Counties: 0360 Anaheim-Santa Ana-Garden Grove, CA	11.9
	CA Orange	28.3
	4480 Los Angeles-Long Beach, CA	
	CA Los Angeles	21.5
	6000 Oxnard-Simi Valley-Ventura, CA	
	CA Ventura	19.0
	6780 Riverside-San Bernardino-Ontario, CA	
181	CA Riverside; CA San Bernardino	19.7
	7480 Santa Barbara-Santa Maria-Lompoc, CA	
	CA Santa Barbara	24.6
	Non-SMSA Counties	
	CA Inyo; CA Mono; CA San Luis Obispo	
	San Diego, CA: SMSA Counties	16.9
	7320 San Diego, CA	
CA San Diego	18.2	
	Non-SMSA Counties	
	CA Imperial	

For the last full week of July during which work is performed under the contract, the prime contractor and each non material-supplier subcontractor with a subcontract of \$10,000 or more must complete Form FHWA PR-1391 (Appendix C to 23 CFR 230). Submit the forms by August 15.

13. TITLE VI ASSURANCES

The U.S. Department of Transportation Order No.1050.2A requires all federal-aid Department of Transportation contracts between an agency and a contractor to contain Appendix A and E. Appendix B only requires inclusion if the contract impacts deeds effecting or recording the transfer of real property, structures, or improvements thereon, or granting interest therein. Appendices C and D only require inclusion if the contract impacts deeds, licenses, leases, permits, or similar instruments entered into by the recipient.

APPENDIX A

During the performance of this Agreement, the contractor, for itself, its assignees and successors in interest (hereinafter collectively referred to as CONTRACTOR) agrees as follows:

- a. Compliance with Regulations: CONTRACTOR shall comply with the regulations relative to nondiscrimination in federally assisted programs of the Department of Transportation, Title 49, Code of Federal Regulations, Part 21, as they may be amended from time to time, (hereinafter referred to as the REGULATIONS), which are herein incorporated by reference and made a part of this agreement.
- b. Nondiscrimination: CONTRACTOR, with regard to the work performed by it during the AGREEMENT, shall not discriminate on the grounds of race, color, sex, national origin, religion, age, or disability in the selection and retention of sub-applicants, including procurements of materials and leases of equipment. CONTRACTOR shall not participate either directly or indirectly in the discrimination prohibited by Section 21.5 of the Regulations, including employment practices when the agreement covers a program set forth in Appendix B of the Regulations.
- c. Solicitations for Sub-agreements, Including Procurements of Materials and Equipment: In all solicitations either by competitive bidding or negotiation made by CONTRACTOR for work to be performed under a Sub- agreement, including procurements of materials or leases of equipment,

each potential sub-applicant or supplier shall be notified by CONTRACTOR of the CONTRACTOR'S obligations under this Agreement and the Regulations relative to nondiscrimination on the grounds of race, color, or national origin.

- d. Information and Reports: CONTRACTOR shall provide all information and reports required by the Regulations, or directives issued pursuant thereto, and shall permit access to its books, records, accounts, other sources of information, and its facilities as may be determined by the recipient or FHWA to be pertinent to ascertain compliance with such Regulations or directives. Where any information required of CONTRACTOR is in the exclusive possession of another who fails or refuses to furnish this information, CONTRACTOR shall so certify to the recipient or FHWA as appropriate, and shall set forth what efforts CONTRACTOR has made to obtain the information.
- e. Sanctions for Noncompliance: In the event of CONTRACTOR's noncompliance with the nondiscrimination provisions of this agreement, the recipient shall impose such agreement sanctions as it or the FHWA may determine to be appropriate, including, but not limited to:
 - i. withholding of payments to CONTRACTOR under the Agreement within a reasonable period of time, not to exceed 90 days; and/or
 - ii. cancellation, termination or suspension of the Agreement, in whole or in part.
- f. Incorporation of Provisions: CONTRACTOR shall include the provisions of paragraphs (1) through (6) in every sub-agreement, including procurements of materials and leases of equipment, unless exempt by the Regulations, or directives issued pursuant thereto.

CONTRACTOR shall take such action with respect to any sub-agreement or procurement as the recipient or FHWA may direct as a means of enforcing such provisions including sanctions for noncompliance, provided, however, that, in the event CONTRACTOR becomes involved in, or is threatened with, litigation with a sub-applicant or supplier as a result of such direction, CONTRACTOR may request the recipient enter into such litigation to protect the interests of the State, and, in addition, CONTRACTOR may request the United States to enter into such litigation to protect the interests of the United States.

APPENDIX B

CLAUSES FOR DEEDS TRANSFERRING UNITED STATES PROPERTY

The following clauses will be included in deeds effecting or recording the transfer of real property, structures, or improvements thereon, or granting interest therein from the United States pursuant to the provisions of Assurance 4:

NOW THEREFORE, the U.S. Department of Transportation as authorized by law and upon the condition that the recipient will accept title to the lands and maintain the project constructed thereon in accordance with Title 23 U.S.C., the regulations for the administration of the preceding statute, and the policies and procedures prescribed by the FHWA of the U.S. Department of Transportation in accordance and in compliance with all requirements imposed by Title 49, Code of Federal Regulations, U.S. Department of Transportation, Subtitle A, Office of the Secretary, Part 21, Non-discrimination in Federally-assisted programs of the U.S. Department of Transportation pertaining to and effectuating the provisions of Title VI of the Civil Rights Act of 1964 (78 Stat. 252; 42 U.S.C. § 2000d to 2000d-4), does hereby remise, release, quitclaim and convey unto the recipient all the right, title and interest of the U.S. Department of Transportation in and to said lands described in Exhibit A attached hereto and made a part hereof.

(HABENDUM CLAUSE)

TO HAVE AND TO HOLD said lands and interests therein unto the recipient and its successors forever, subject, however, to the covenants, conditions, restrictions and reservations herein contained as follows, which will remain in effect for the period during which the real property or structures are used for a purpose for which Federal financial assistance is extended or for another purpose involving the provision of similar services or benefits and will be binding on the recipient, its successors and assigns. The recipient, in consideration of the conveyance of said lands and interest in lands, does hereby covenant and agree as a covenant running with the land for itself, its successors and assigns, that (1) no person

will on the grounds of race, color, or national origin, be excluded from participation in, be denied the benefits of, or be otherwise subjected to discrimination with regard to any facility located wholly or in part on, over, or under such lands hereby conveyed [,] [and]* (2) that the recipient will use the lands and interests in lands and interest in lands so conveyed, in compliance with all requirements imposed by or pursuant to Title 49, Code of Federal Regulations, U.S. Department of Transportation, Subtitle A, Office of the Secretary, Part 21, Non-discrimination in Federally-assisted programs of the U.S. Department of Transportation, Effectuation of Title VI of the Civil Rights Act of 1964, and as said Regulations and Acts may be amended[, and (3) that in the event of breach of any of the above-mentioned non-discrimination conditions, the Department will have a right to enter or re-enter said lands and facilities on said lands, and that above described land and facilities will thereon revert to and vest in and become the absolute property of the U.S. Department of Transportation and its assigns as such interest existed prior to this instruction].*

(*Reverter clause and related language to be used only when it is determined that such a clause is necessary in order to make clear the purpose of Title VI.)

APPENDIX C

CLAUSES FOR TRANSFER OF REAL PROPERTY ACQUIRED OR IMPROVED UNDER THE ACTIVITY, FACILITY, OR PROGRAM

The following clauses will be included in deeds, licenses, leases, permits, or similar instruments entered into by the recipient pursuant to the provisions of Assurance 7(a):

A. The (grantee, lessee, permittee, etc. as appropriate) for himself/herself, his/her heirs, personal representatives, successors in interest, and assigns, as a part of the consideration hereof, does hereby covenant and agree [in the case of deeds and leases add "as a covenant running with the land"] that:

1. In the event facilities are constructed, maintained, or otherwise operated on the property described in this (deed, license, lease, permit, etc.) for a purpose for which a U.S. Department of Transportation activity, facility, or program is extended or for another purpose involving the provision of similar services or benefits, the (grantee, licensee, lessee, permittee, etc.) will maintain and operate such facilities and services in compliance with all requirements imposed by the Acts and Regulations (as may be amended) such that no person on the grounds of race, color, or national origin, will be excluded from participation in, denied the benefits of, or be otherwise subjected to discrimination in the use of said facilities.

B. With respect to licenses, leases, permits, etc., in the event of breach of any of the above Non-discrimination covenants, the recipient will have the right to terminate the (lease, license, permit, etc.) and to enter, re-enter, and repossess said lands and facilities thereon, and hold the same as if the (lease, license, permit, etc.) had never been made or issued.*

C. With respect to a deed, in the event of breach of any of the above Non-discrimination covenants, the recipient will have the right to enter or re-enter the lands and facilities thereon, and the above described lands and facilities will there upon revert to and vest in and become the absolute property of the recipient and its assigns.*

(*Reverter clause and related language to be used only when it is determined that such a clause is necessary to make clear the purpose of Title VI.)

APPENDIX D

CLAUSES FOR CONSTRUCTION/USE/ACCESS TO REAL PROPERTY ACQUIRED UNDER THE ACTIVITY, FACILITY OR PROGRAM

The following clauses will be included in deeds, licenses, permits, or similar instruments/agreements entered into by the recipient pursuant to the provisions of Assurance 7(b):

A. The (grantee, licensee, permittee, etc., as appropriate) for himself/herself, his/her heirs, personal representatives, successors in interest, and assigns, as a part of the consideration hereof, does hereby covenant and agree (in the case of deeds and leases add, "as a covenant running with the land") that (1) no person on the ground of race, color, or national origin, will be excluded from participation in, denied the benefits of, or be otherwise subjected to discrimination in the use of said facilities, (2) that in the construction of any improvements on, over, or under such land, and the furnishings of services thereon, no person on the ground of race, color, or national origin, will be excluded from participation in, denied the benefits or, or otherwise be subjected to discrimination, (3) that the (grantee, licensee, lessee, permittee, etc.) will use the premises in compliance with all other requirements imposed by or pursuant to the Acts and Regulations, as amended, set forth in this Assurance.

B. With respect to (licenses, leases, permits, etc.) in the event of breach of any of the above of the above Non-discrimination covenants, the recipient will have the right to terminate the (license, permits, etc., as appropriate) and to enter or re-enter and repossess said land and the facilities thereon, and hold the same as if said (license, permit, etc., as appropriate) had never been made or issued.*

C. With respect to deeds, in the event of breach of any of the above Non-discrimination covenants, the recipient will there upon revert to and vest in and become the absolute property of the recipient and its assigns.

(*Reverter clause and related language to be used only when it is determined that such a clause is necessary to make clear the purpose of Title VI.)

APPENDIX E

During the performance of this contract, the contractor, for itself, its assignees, and successors in interest (hereinafter referred to as the "contractor") agrees to comply with the following non-discrimination statutes and authorities, including, but not limited to:

Pertinent Non-Discrimination Authorities:

- Title VI of the Civil Rights Act of 1964 (42 U.S.C. § 2000d et seq., 78 stat. 252), prohibits discrimination on the basis of race, color, national origin); and 49 CFR Part 21.
- The Uniform Relocation Assistance and Real Property Acquisition Policies Act of 1970, (42 U.S.C. § 4601), (prohibits unfair treatment of persons displaced or whose property has been acquired because of Federal or Federal-aid programs and projects);
- Federal-Aid Highway Act of 1973, (23 U.S.C. § 324 et seq.), prohibits discrimination on the basis of sex;
- Section 504 of the Rehabilitation Act of 1973, (29 U.S.C. § 794 et seq.), as amended, (prohibits discrimination on the basis of disability); and 49 CR Part 27;
- The Age Discrimination Act of 1975, as amended, (42 U.S.C. § 6101 et seq.), prohibits discrimination on the basis of age);
- Airport and Airway Improvement Act of 1982, (49 U.S.C. § 471, Section 47123), as amended, (prohibits discrimination based on race, creed, color, national origin, or sex);
- The Civil Rights Restoration Act of 1987, (PL 100-209), (Broadened the scope, coverage and applicability of Title VI of the Civil Rights Act of 1964, The Age Discrimination Act of 1975 and Section 504 of the Rehabilitation Act of 1973, by expanding the definition of the terms "programs or activities" to include all of the programs or activities of the Federal-aid recipients, sub-recipients and contractors, whether such programs or activities are Federally funded or not);

-
- Titles II and III of the Americans with Disabilities Act, which prohibit discrimination on the basis of disability in the operation of public entities, public and private transportation systems, places of public accommodation, and certain testing entities (42 U.S.C. §§ 12131 – 12189) as implemented by Department of Transportation regulations 49 C.F.R. parts 37 and 38;
 - The Federal Aviation Administration’s Non-discrimination statute (49 U.S.C. § 47123) (prohibits discrimination on the basis of race, color, national origin, and sex);
 - Executive Order 12898, Federal Actions to Address Environmental Justice in Minority Populations and Low-Income Populations, which ensures discrimination against minority populations by discouraging programs, policies, and activities with disproportionately high and adverse human health or environmental effects on minority and low-income populations;
 - Executive Order 13166, Improving Access to Services for Persons with Limited English Proficiency, and resulting agency guidance, national origin discrimination includes discrimination because of limited English proficiency (LEP). To ensure compliance with Title VI, you must take reasonable steps to ensure that LEP persons have meaningful access to your programs (70 Fed. Reg. at 74087 to 74100);
 - Title IX of the Education Amendments of 1972, as amended, which prohibits you from discriminating because of sex in education programs or activities (20 U.S.C. 1681 et seq).

Federal Trainee Program Special Provisions
(to be used when applicable)

14. FEDERAL TRAINEE PROGRAM

For the Federal training program, the number of trainees or apprentices is ____.

This section applies if a number of trainees or apprentices is specified in the special provisions.

As part of the prime contractor's equal opportunity affirmative action program, provide on-the-job training to develop full journeymen in the types of trades or job classifications involved.

The prime contractor has primary responsibility for meeting this training requirement.

If the prime contractor subcontracts a contract part, they shall determine how many trainees or apprentices are to be trained by the subcontractor. Include these training requirements in each subcontract.

Where feasible, 25 percent of apprentices or trainees in each occupation must be in their 1st year of apprenticeship or training.

Distribute the number of apprentices or trainees among the work classifications on the basis of the prime contractor's needs and the availability of journeymen in the various classifications within a reasonable recruitment area.

Before starting work, the prime contractor shall submit to the City/County of _____ :

1. Number of apprentices or trainees to be trained for each classification
2. Training program to be used
3. Training starting date for each classification

The prime contractor shall obtain the City/County of _____ approval for this submitted information before the prime contractor starts work. The City/County of _____ credits the prime contractor for each apprentice or trainee the prime contractor employs on the job who is currently enrolled or becomes enrolled in an approved program.

The primary objective of this section is to train and upgrade minorities and women toward journeyman status. The prime contractor shall make every effort to enroll minority and women apprentices or trainees, such as conducting systematic and direct recruitment through public and private sources likely to yield minority and women apprentices or trainees, to the extent they are available within a reasonable recruitment area and show that they have made the efforts. In making these efforts, the prime contractor shall not discriminate against any applicant for training.

The prime contractor shall not employ as an apprentice or trainee an employee:

1. In any classification in which the employee has successfully completed a training course leading to journeyman status or in which the employee has been employed as a journeyman
2. Who is not registered in a program approved by the US Department of Labor, Bureau of Apprenticeship and Training

The prime contractor shall ask the employee if the employee has successfully completed a training course leading to journeyman status or has been employed as a journeyman. The prime contractor's records must show the employee's answers to the questions.

In the training program, the prime contractor shall establish the minimum length and training type for each classification. The City/County of _____ and FHWA approves a program if one of the following is met:

1. It is calculated to:
 - Meet the equal employment opportunity responsibilities
 - Qualify the average apprentice or trainee for journeyman status in the classification involved by the end of the training period
2. It is registered with the U.S. Department of Labor, Bureau of Apprenticeship and Training, and it is administered in a way consistent with the equal employment responsibilities of Federal-aid highway construction contracts

The prime contractor shall obtain the State's approval for their training program before they start work involving the classification covered by the program.

The prime contractor shall provide training in the construction crafts, not in clerk-typist or secretarial-type positions. Training is allowed in lower level management positions such as office engineers, estimators, and timekeepers if the training is oriented toward construction applications. Training is allowed in the laborer classification if significant and meaningful training is provided and approved by the division office. Off-site training is allowed if the training is an integral part of an approved training program and does not make up a significant part of the overall training.

The City/County of _____ reimburses the prime contractor 80 cents per hour of training given an employee on this contract under an approved training program:

1. For on-site training
2. For off-site training if the apprentice or trainee is currently employed on a Federal-aid project and prime contractor does at least one of the following:
 - a. Contribute to the cost of the training
 - b. Provide the instruction to the apprentice or trainee
 - c. Pay the apprentice's or trainee's wages during the off-site training period
3. If the prime contractor complies with this section.

Each apprentice or trainee must:

1. Begin training on the project as soon as feasible after the start of work involving the apprentice's or trainee's skill
2. Remain on the project as long as training opportunities exist in the apprentice's or trainee's work classification or until the apprentice or trainee has completed the training program

The prime contractor shall furnish the apprentice or trainee with a copy of the program that the prime contractor will comply with in providing the training.

15. PROHIBITION OF CERTAIN TELECOMMUNICATIONS AND VIDEO SURVEILLANCE EQUIPMENT AND SERVICES

In response to significant national security concerns, the agency shall check the prohibited vendor list before making any telecommunications and video surveillance purchase because recipients and subrecipients of federal funds are prohibited from obligating or expending loan or grant funds to:

- Procure or obtain;
- Extend or renew a contract to procure or obtain; or
- Enter into a contract (or extend or renew a contract) to procure or obtain equipment, services, or systems that uses covered telecommunications equipment or services as a substantial or essential component of any system, or as critical technology as part of any system.

The prohibited vendors (and their subsidiaries or affiliates) are:

- Huawei Technologies Company;
- ZTE Corporation;
- Hytera Communications Corporation;
- Hangzhou Hikvision Digital Technology Company;
- Dahua Technology Company; and
- Subsidiaries or affiliates of the above-mentioned companies.

In implementing the prohibition, the agency administering loan, grant, or subsidy programs shall prioritize available funding and technical support to assist affected businesses, institutions and organizations as is reasonably necessary for those affected entities to transition from covered communications equipment and services, to procure replacement equipment and services, and to ensure that communications service to users and customers is sustained.

The contractors should furnish telecommunications and video surveillance equipment with a certificate of compliance. The certificate must state telecommunications and video surveillance equipment was not procured or obtained from manufacturers identified in the above list.

CITY OF MISSION VIEJO
GENERAL SPECIFICATIONS
MELINDA ROAD PAVEMENT REHABILITATION
FROM OLYMPIAD ROAD TO SANTA MARGARITA PARKWAY

CIP NO. 837

SCOPE OF WORK

The Work to be done consists of furnishing all permits, licenses, testing, materials, equipment, tools, labor and incidentals as required by the Contract Documents to construct the above-stated project, as well as any other duties or obligations of Contractor under the Contract Documents.

The general items of Work include, but are not limited to, demolition and removals, roadway improvements of failed pavement areas, cold milling AC pavement, resurfacing with ARHM overlay, reconstruction of PCC access ramps, curb, gutter, and sidewalk, adjusting utility structures to new grade, replacing traffic signal loops, striping and pavement markings on Melinda Road from Olympiad Road to Santa Margarita Parkway.

LOCATION OF WORK

The general locations and limits of the Work are as follows:

Melinda road from Olympiad Road to Santa Margarita Parkway in the City of Mission Viejo.

TIME OF COMPLETION

The Contractor shall Complete all Work in every detail within 45 working days (as defined in the Greenbook Standard Specifications; see below) after the date of the Notice to Proceed, exclusive of maintenance periods.

PERFORMANCE OF AT LEAST 50% OF THE WORK

The City waives and deletes Standard Specification Section 2-3.2, and Contractor may subcontract more than 50% of the Work to subcontractors.

UTILITY REQUIREMENTS

The Contractor is advised of the existence of the utility notification service provided by UNDERGROUND SERVICE ALERT (USA). USA member utilities will provide the Contractor with the precise locations of their substructures in the construction area when the Contractor gives at least 48 hours' notice to the Underground Service Alert by calling 1-800-422-4133.

The Contractor shall notify the following agencies at least 48 hours in advance of excavating around any of their structures. The utility companies listed below can be contacted as indicated.

AT&T California

3939 East Coronado Street, Second Floor
Anaheim, California 92807
Valentina Gipson 714-618-9132
vk3921@att.com

Cox Communications

29947 Avenida de las Banderas
Rancho Santa Margarita, California 92688
Sina Muckenfuss 949-546-2485
sina.muckenfuss@cox.com

Santa Margarita Water District

26111 Antonio Parkway
Rancho Santa Margarita, California 92688
Jeff MacDonnell 949-459-6504
jeffm@smwd.com

Metropolitan Water District of Southern California

Richard Ford
714-577-5088

Southern California Gas Company
1919 South State College Boulevard, SC8320
Anaheim, California 92806
Andrew Alday 714-358-3377
aalday@semprautilities.com

Southern California Edison
14155 Bake Parkway
Irvine, California 92619
Todd Tate 949-458-4419
todd.tate@sce.com

City of Mission Viejo
Public Services Department
27204 East La Paz Road
Mission Viejo, California 92692
949-470-3064

The California Public Utilities Commission mandates that, in the interest of public safety, mainline gas valves be maintained in a manner to be readily accessible and in good operating condition. The Contractor shall notify the Southern California Gas Company's Headquarters Planning Office at 714-369-0680, at least two (2) working days prior to the start of construction.

The Contractor shall exercise extreme care to protect all existing utilities in place whether shown on the plans or not, and shall assume full responsibility for all damage resulting from its operations. The Contractor shall coordinate with each utility company as to the requirements and methods for protection of their facilities during the construction period and shall be responsible for preparation and processing of any required plans or permits. The Contractor shall assume full responsibility to maintain uninterrupted service for all utilities.

By submitting a bid, the Contractor acknowledges the above-referenced utility work to be done in conjunction with this project. The Contractor shall schedule its work and conduct its operations so as to permit access and time for the required utility work to be accomplished during the progress of the work.

The Contractor shall coordinate with each utility company as to the extent of required work and the time required to do so. The Contractor shall include this time in its schedule. Payment for the above, if any, shall be deemed as included in the items of work as shown on the proposal bid sheet and no additional compensation will be allowed.

FLOW AND ACCEPTANCE OF WATER

It is anticipated that storm, surface, or other waters will be encountered at various times during the work herein contemplated. The Contractor, by submitting a bid, acknowledges that he has investigated the risk arising from such waters and has prepared his bid accordingly; and Contractor submitting a bid assumes all said risk.

The Contractor shall conduct his operations in such a manner that storm or other existing waters may proceed uninterrupted along their existing street or drainage courses. Diversions of water for short reaches to protect construction in progress will be permitted if public and/or private properties, in the opinion of the Engineer, are not subject to probability of damage. The Contractor shall obtain written permission from the applicable public agency or property owner before any diversion of water outside of public right-of-way will be permitted.

REMOVAL OF WATER

The Contractor shall provide and maintain at all times during construction ample means and devices to promptly remove and properly dispose of all water entering the excavations or other parts of the work. No concrete footing or floor shall be laid in water, nor shall water be allowed to rise over them until the concrete or mortar has set. Dewatering for the structures and pipelines shall commence when ground water is first encountered and shall be continuous until such time as water can be allowed to rise in accordance with the above paragraph. Dewatering shall be accomplished by well points or some other method which will insure a dry hole and preservation of final lines and grade of the bottoms of excavation, all subject to the approval of the Engineer.

Disposal of water from dewatering operations shall be the sole responsibility of the Contractor. Disposal methods shall conform to the Porter-Cologne Water Quality Control Act of 1974, the Federal Water Pollution Control Act Amendments of 1972, and the California Administrative Code, Title 23, Chapter 3.

Full compensation of dewatering shall be considered as included in the contract prices paid for the related items of work, and no additional compensation will be allowed therefore.

TRENCH SAFETY AND SHORING EXCAVATION

In accordance with Section 6500 of the Labor Code, the Contractor is required to obtain a permit from the Division of Industrial Safety for any trench or excavation which is five feet (5') or more in depth and into which a person is required to descend.

The Contractor shall furnish all labor, equipment, and materials required to design, construct, and remove all sheeting, shoring, and bracing or other equivalent method of support of this project.

Excavation for any trench five feet (5') or more in depth shall not begin until the Contractor has received approval from the Engineer of the Contractor's detailed plan for worker protection from hazards of caving ground. Such plan shall be submitted at least five (5) days before the Contractor intends to begin excavation and shall show the details of the design of shoring, bracing, sloping, or other provisions to be made for worker protection during excavation. No such plan shall allow the use of shoring, sloping, or a protective system less effective than required by Construction Safety Orders of the Division of Industrial Safety; and if such plan varies from the shoring system standards established by the Construction Safety Orders, the plan shall be prepared and signed by the Engineer who is registered as a Civil or Structural Engineer in the State of California.

Prior to beginning of excavations requiring shoring, the Contractor shall designate in writing to the Engineer someone whose responsibility it is to supervise the project safety measures and someone whose responsibility it is to supervise the installation and removal of sheeting, shoring and bracing.

In addition to shoring the excavations in accordance with the minimum requirements of Industrial Safety Orders, it shall be the Contractor's responsibility to provide any and all additional shoring required to support the sides of the excavation against the effects of load which may exceed those desired by using the criteria set forth in the Industrial Safety Orders. The Contractor shall be solely responsible for any damages which may result from his failure to provide adequate shoring of the excavation under any and all of the conditions of loading which may exist or which may arise during construction of the project.

The Contractor shall include in his bid all costs for the above requirements. Full compensation for sheeting, shoring, bracing, and all other things necessary shall be considered as included in the appropriate bid items of work, and no additional allowance will be made therefore.

STANDARD SPECIFICATIONS

The Standard Specifications of the City are contained in the most recent edition of the *Standard Specifications for Public Works Construction*, Latest Edition, including all supplements as written and promulgated by the Joint Cooperative Committee of the Southern California District of the Associated General Contractors of California. Copies of these Standard Specifications (the "Greenbook") are available from the publisher:

Building News, Incorporated
1612 South Clementine Street, Suite A
Anaheim, California 92802
714-517-0970

The section numbers of the City's General Provisions and Special Provisions coincide with those of the *Standard Specifications for Public Works Construction*. Only those sections requiring amendment or elaboration, or specifying options, are called out.

Where the plans or specifications describe portions of the work in general terms, but not in complete detail, it is understood that the item is to be furnished and installed complete and in place and that only the best general practice is to be used. Unless otherwise specified, the Contractor shall furnish all labor, materials, tools, equipment, and incidentals, and perform all the work, involved in executing the contract.

WAGE RATES AND LABOR CODE REQUIREMENTS

Wage Rates

The Contractor and all Subcontractors shall be required to adhere to the general prevailing rate of per diem wages as determined and published by the State Director of the Department of Industrial Relations, pursuant to Sections 1770, 1773, and 1773.2 of the California Labor Code. Copies of these rates and the latest revisions thereto are on file in the Office of the Secretary of the Board of Directors and are available for review upon request.

Attention is directed to the provisions of Sections 1774, 1775, 1776, 1777.5 and 1777.6 of the State Labor Code. Sections 1774 and 1775 require the Contractor and all Subcontractors to pay not less than the prevailing wage rates to all workmen employed in the execution of the contract and specify forfeitures and penalties for failure to do so. The minimum wages to be paid are those determined by the State Director of the Department of Industrial Relations. Section 1776 requires the Contractor and all Subcontractors to keep accurate payroll records, specifies the contents thereof, their inspection and duplication procedures and certain notices required of the Contractor pertaining to their location.

Apprentices

Section 1777.5 requires the Contractor or Subcontractor employing tradesmen in any apprentice-able occupation to apply to the Joint Apprenticeship Committee nearest the site of the public works project which administers the apprenticeship program in that trade for a certificate of approval. The certificate will also fix the ratio of apprentices to journeymen to be used in the performance of the contract.

The Contractor is required to make contributions to funds established for the administration of apprenticeship programs if he employs registered apprentices or journeymen in any apprentice-able trade and if other Contractors on the public work site are making such contributions.

Information relative to apprenticeship standards, contributions, wage schedules, and other requirements may be obtained from the State Director of Industrial Relations or from the Division of Apprenticeship Standards.

CLAYTON ACT AND CARTWRIGHT ACT

Section 4551 of the State Government Code specifies that in executing a public works contract with the City to supply goods, services, or materials, the Contractor or Subcontractors offer and agree to assign to the City all rights, title and interest in and to all causes of action it may have under Section 4 of the Clayton Act (15 USC Section 15) or under the Cartwright Act (Chapter 2 commencing with Section 16700) of Part 2 of Division 7 of the Business and Professional Code arising from purchase of goods, services, or materials pursuant to the contract or subcontract. This assignment shall become effective when the City tenders final payment to the Contractor without further acknowledgment by the parties.

SUBSTITUTION OF SECURITIES

In conformance with the State of California Government Code Chapter 13, Section 4590, the Contractor may substitute securities for any moneys withheld by the City to ensure performance under the contract.

At the request and expense of the Contractor, securities equivalent to the amount withheld shall be deposited with the City or with a State- or Federally-chartered bank as the escrow agent who shall pay such moneys to the Contractor upon notification by City of Contractor's satisfactory completion of the contract. The form for this escrow agreement, as required by Public Contract Code Section 22300, may be obtained from the City Attorney's office.

The type of securities deposited and the method of release shall be approved by the City Attorney's office.

WATER POLLUTION CONTROL (NPDES COMPLIANCE)

The City of Mission Viejo in conformance with the City's National Pollutant Discharge Elimination System (NPDES) Permit, is dedicated to the elimination/reduction of water pollution as a result of construction projects. The Contractor shall comply with the items described in this section and construct those facilities as specified by these Contract Documents, as required by law, or as directed by the Engineer, as necessary to eliminate/reduce water pollution. Said items are intended to provide prevention, control, and abatement of water pollution into storm drain systems, streams, oceans, and other bodies of water as a result of the Contractor's operations. These items are supplemental to those required of the Contractor in Section 7-8 "Project Site Maintenance" of the Standard Specifications for Public Works Construction.

1. Concrete and Mortar Products:

The Contractor shall prevent or reduce the discharge of pollutants into stormwater or stormwater systems from concrete waste by conducting washouts at appropriate off-site locations, performing on-site washouts in a designated area, and providing appropriate training for employees and subcontractors.

The Contractor shall store and mix dry and wet materials either off-site or under cover, away from drainage areas.

For washout of concrete trucks, the Contractor shall provide appropriate off-site locations or designated contained areas at least fifty feet (50') away from storm drains, open ditches, streets, or streams.

The Contractor shall prevent run-off from designated washout areas by constructing a temporary pit or bermed area large enough to handle all produced liquid and solid waste. When concrete sets, break up and dispose of concrete in construction fills per direction of the soils engineer or dispose of it as solid waste and/or recycle.

The Contractor shall inform concrete suppliers and subcontractors of the designated washout locations and disposal sites for concrete and mortar products and shall be responsible for ensuring that all workers use it appropriately.

2. Construction Water:

The Contractor shall reduce or eliminate excessive construction water that may cause erosion and carry pollutants from the site. In addition, the Contractor shall:

1. Store construction water in leak-proof tanks located away from drainage systems.
2. Use construction water conservatively.
3. Whenever possible, dispose of excess water on-site, by allowing it to soak into the ground.

3. Saw-cutting Water Runoff:

Saw-cutting water runoff contains pollutants that must be contained and disposed of properly. The Contractor shall:

1. Prevent saw-cut water runoff from entering catch basins, manholes, and storm drains.
2. Direct water into a temporary pit and dispose of the water by vacuuming the water into a truck and removing the water from the site.
3. Place drip pans or absorbent materials under saw-cutting equipment when not in use.
4. Clean up spills with absorbent materials rather than burying. Dispose of absorbent material properly.

4. Housekeeping/Cleanup

The Contractor shall prevent pollution of stormwater from cleanup and disposal operations by using good housekeeping methods. When fluids or dry materials spill, cleanup should be immediate, thorough, and routine. The Contractor shall never attempt to "wash them away" with water, or bury them. The Contractor shall report significant spills to the appropriate spill response agencies immediately. The Contractor shall recognize that different types of materials have different disposal requirements and follow appropriate practices. The Contractor shall confine non-hazardous debris to dumpsters, covered at night or during wet weather, and take the debris to a landfill for recycling or disposal. The Contractor shall handle hazardous debris in accordance with specific laws and regulations and dispose of them properly. A separate permit may be required. Common hazardous debris found on construction sites are: Liquid residues from paints, thinners, solvents, glues, and cleaning fluids, leaching agents from lumber such as formaldehyde, arsenic, copper, creosote and chromium, motor oil, gear oil, antifreeze fluids, brake fluids, etc., and unused pesticides.

5. Sanitary Waste Management:

The Contractor shall prevent the discharge of sanitary waste into stormwater systems by providing convenient, properly located, well-maintained facilities. The Contractor shall hire a licensed portable sanitary facility leasing company, which will clean the facilities regularly and keep them in good working order. The Contractor shall make sure that portable sanitary facilities are located on relatively level ground away from traffic areas, drainage courses, and storm drain courses and storm drain inlets. The Contractor shall regularly inspect the facilities for any leaks, and have defective units replaced.

6. Vehicle and Equipment Management:

The Contractor shall use and maintain construction vehicles and equipment in a manner that prevents leaks and spills of fluids, contains wash waters, and controls off-site tracking. The Contractor shall not allow leaking vehicles and equipment on-site and shall inspect equipment and vehicles frequently for leaks and repair them

immediately. The Contractor shall clean up spills and leaks promptly with absorbent materials, and shall not flush said spills with water.

The Contractor shall fuel, maintain, and repair vehicles and equipment off-site whenever possible and on-site only in designated areas. The Contractor shall prevent run-on and run-off from designated areas and provide cover as well as containment devices as necessary.

The Contractor shall wash vehicles and equipment on-site in designated, contained areas, allowing wash waters to infiltrate into the ground. The Contractor shall use phosphate-free, biodegradable soaps, and limit steam cleaning to confined areas only.

When not in use, the Contractor shall store equipment and vehicles in designated, contained areas and place drip pans and absorbent material under stored equipment that is prone to leaking and dripping (e.g., paving equipment).

If the Contractor must drain and replace motor oil, radiator coolant, or other fluids on-site, use drip pans or drop cloths to catch drips and spills. The Contractor shall collect all spent fluids, store in separate containers, and recycle whenever possible. Note: For recycling purposes, such liquids must not be mixed with other fluids. Non-recycled fluids generally must be disposed of as hazardous waste.

Except as otherwise provided for in the Standard Specifications or elsewhere in these Special Provisions, full compensation for conforming to the requirements of this section including furnishing all labor, tools, equipment, and materials necessary for doing the work, shall be considered as included in the prices paid for the various contract items of work and no additional compensation will be allowed therefore.

NOTE: The City of Mission Viejo is a co-permittee with the County of Orange for the water discharge from the San Diego Regional Water Quality Control Board. The Contractor will be held accountable and should make himself aware of all municipal activities procedures as part of the NPDES permit and program.

CITY OF MISSION VIEJO
SPECIAL PROVISIONS
MELINDA ROAD PAVEMENT REHABILITATION
FROM OLYMPIAD ROAD TO SANTA MARGARITA PARKWAY

CIP NO. 837

These Special Provisions amend the Standard Specifications as indicated and take precedence over the General Specifications and Standard Specifications (see revised order of precedence, below [Section 3-7.2]).

PART 1—GENERAL PROVISIONS

SECTION 1 TERMS, DEFINITIONS, ABBREVIATIONS, UNITS OF MEASURE, AND SYMBOLS

1-2 TERMS AND DEFINITIONS [Add the following]:

The definitions in this section apply throughout the Contract Documents.

Agency	City of Mission Viejo
Board	City Council for the City of Mission Viejo
City	City of Mission Viejo
County	County of Orange (OCPW)
Engineer	City Engineer
Federal	United States of America
Inspector	Inspector for the Agency (or his designee)
State	State of California

Change Order [add the following sentence to the definition:] If signed by the Agency and Contractor, and approved by the Board (or approved by the City Manager if changes cumulatively total less than 15% of the Contract price or \$30,000, whichever is less), the Change Order qualifies as a Supplemental Amendment.

Completion and Complete Statutory definitions of "Completion" and "Complete" shall apply for those statutory purposes (for example, see Public Contract Code Section 7107 for release of retention, and Civil Code Section 9200 for stop payment notices and notice of completion). For all other purposes, including accrual of liquidated damages, claims, and warranties, "Completion" and "Complete" mean the point in the Work where (1) Contractor has fully and correctly performed all Work in all parts and requirements, including corrective and punch list work, and (2) City's representatives have conducted a final inspection that confirmed this performance. Substantial, or any other form of partial or non-compliant, performance shall not constitute "Completion" or "Complete."

Supplemental Agreement [replace the definition with the following:] A written amendment of the Contract Documents signed by the Agency and the Contractor, and approved by the Board (or approved by the City Manager if changes cumulatively total less than 15% of the Contract price or \$30,000, whichever is less), including but not limited to a Change Order.

Working Day [Add the following:] The Contractor's activities shall be confined to the hours between 8:30 a.m. and 4:30 p.m., Monday through Friday, excluding holidays on Working Days. Deviation from these hours will not be permitted without the prior written consent of City, except in emergencies involving immediate hazard to persons or property or the reprogramming of Portable Changeable Message Signs. In the event of either a requested or emergency deviation, inspection service fees will be charged against the Contractor. The service fees will be calculated at overtime rates, including benefits, overhead, and travel time. The service fees will be deducted from any amounts due the Contractor.

1-7 AWARD AND EXECUTION OF CONTRACT [Replace with the following]:

Within ten (10) working days after the date of the Notice to Award, the Contractor shall execute and return the following contract documents to the Agency:

- Contract Agreement
- Faithful Performance Bond
- Payment Bond
- Proof of Insurance, including Policies, Endorsements, and a Public Liability and Property Damage Insurance Certificate
- Workers' Compensation Insurance Certificate

Failure to comply with the above will result in annulment of the award and forfeiture of the Proposal Guarantee. The Contract Agreement shall not be considered binding upon the Agency until executed by the authorized Agency officials.

A corporation to which an award is made may be required, before the Contract Agreement is executed by the Agency, to furnish evidence of its corporate existence, of its right to enter into contracts in the State of California, and that the officers signing the contract and bonds for the corporation have the authority to do so.

1-7.2 CONTRACT BONDS [Add the following]:

The Faithful Performance Bond will remain in effect until actions against Contractor, including those for patent and latent deficiencies, may no longer be timely filed, including but not limited to the 10-year period of Code of Civil Procedure Section 337.15.

SECTION 2 SCOPE OF THE WORK

2-1 WORK TO BE DONE [Add the following to the end of the paragraph:]

Contractor shall expeditiously perform all changes in the Work as directed by Agency. See Section 2-7.1 regarding changes in the Work.

If Contractor believes that acts or omissions of City (including but not limited to City-caused delay) have prevented Contractor from performing the Work as required by the Contract Documents and Contractor intends to rely on City's acts or omissions and Civil Code Section 1511(1) as reasons to excuse Contractor's nonperformance or to support, among other things, Contractor's requests for time extensions (see Section 6-4, below), Contractor shall provide written notice of the excuse within five (5) days of the City's acts or omissions. If Contractor fails to timely submit the written notice, Contractor shall have waived any right to later rely on the acts or omissions as a defense to Contractor's nonperformance or as the basis for a time extension, regardless of the merits of the defense or time extension, as Contractor will not have satisfied a condition precedent or exhausted administrative remedies. Contractor acknowledges that these written notices are of critical importance to the City's Project management of the Work and Project and the mitigation of costs and delays to the Work and Project.

2-2 PERMITS [Replace the first sentence with the following:]

Prior to the start of any Work, the Contractor shall take out and pay for the applicable Agency permits and make arrangements for Agency inspections. The Contractor and all subcontractors shall each obtain any and all other permits, licenses, inspections, certificates, or authorizations required by any governing body or public utility at the Contractor's own expense, including permits from the water districts including Santa Margarita Water District.

2-5 THE CONTRACTOR'S EQUIPMENT AND FACILITIES

2-5.1 General. [Add the following:]

A noise level limit of 86 dBA at a distance of fifty feet (50') shall apply to all construction equipment on or related to the job, whether owned by the Contractor or not. The use of excessively loud warning signals shall be avoided except in those cases required for the protection of personnel.

2-5.4 Haul Routes [Add the following:]

The Contractor shall maintain the minimum traffic requirements designated in the General Specifications. All traffic delineation and work area protection shall conform to the Work Area Traffic Control Handbook (W.A.T.C.H.). No street or access closure to through traffic will be allowed without the express approval of the Agency.

All existing stop signs, street name signs, and regulatory signs shall be maintained in visible locations during construction and permanently relocated or removed as directed by the plans and the Engineer. Signs which need not be maintained during construction or permanently relocated shall be salvaged to the Agency.

2-7 CHANGES INITIATED BY THE AGENCY

2-7.1 General [Replace the first paragraph with the following]:

The Agency may change the Contract Documents or the scope of the Work, including additions and deletions of Work, by issuing a written Change Order to Contractor. Contractor shall expeditiously perform the revised Work pursuant to the Change Order. Contractor shall sign any Change Order that provides proper reduction of money and time, and/or proper additional money and time, based on the changes in the Work. If Contractor believes the Change Order should have smaller reductions in money or time, or larger increases in money or time, based on the changes in the Work, Contractor must follow the procedures in Section 2-10, below, including but not limited to Notice of Potential Change, Change Order Request, and Claim.

Unless a signed Change Order specifically states otherwise, it shall constitute full and final compensation, both money and time, for the specified issue, and shall act as a complete waiver by Contractor of all claims related to the specified issue.

2-10 DISPUTED WORK [Delete second sentence and add the following]:

Protest Procedures:

If the Contractor considers any Work demanded of him to be outside the requirements of the Contract, or if he considers any instruction, ruling, or decision of the inspector or Engineer to be unfair, he shall, within ten (10) working days after any such demand is made, or instruction, ruling, or decision is given, file a written protest with the Engineer, stating clearly and in detail his objections and reasons therefore, including an estimate of any additional money or time that Contractor believes should be granted by the City under the Contract.

Except for such protests and objections as are made of records, in the manner and within the time above stated, the Contractor shall be deemed to have waived and does hereby waive all claims for extra work, damages and extensions of time on account of demands, instructions, rulings and decisions of the Engineer.

Upon receipt of any such protest from the Contractor, the Engineer shall review the demands, instruction, ruling or decision objected to and shall promptly advise the Contractor, in writing, of his final decision.

Notice of Potential Change:

Contractor shall submit a written Notice of Potential Change for extra work, critical path delay, or additional money or time. Contractor shall submit written Notices of Potential Change to City within five (5) days of Contractor becoming aware of the issues creating the potential for change, unless the issues are, or may soon be, adversely affecting the costs or critical path of the Work, in which case the Contractor must submit the written notice without delay so the City may take immediate action to mitigate cost and schedule impacts of the change, if any. The written notice shall explain the nature of the potential change so the City may take action to mitigate costs and schedule impacts, if necessary.

When submitting a written Notice of Potential Change based on extra work, Contractor shall not perform the extra work until directed in writing to do so by City. When submitting a written Notice of Potential Change for an issue of critical path delay, Contractor shall proactively mitigate the effects of the alleged delay as much as reasonably possible so as to minimize any impact to the schedule, until otherwise directed by City. If Contractor intends to rely on City's acts or omissions in support of a request for a time extension, then Contractor must also provide the notice set forth in Section 2-1, above.

Failure to timely submit a written Notice of Potential Change shall constitute a complete waiver by Contractor of any right to later submit a change order request or pursue a Claim on that issue, or to later pursue any additional money or time extensions in any manner related to that issue, regardless of the merits. Contractor will not have satisfied a

condition precedent or exhausted administrative remedies. Contractor acknowledges that these written notices are of critical importance to the City's Work and Project management and the mitigation of Work and Project costs and delays.

Change Order Requests:

If, after submitting a written Notice of Potential Change, Contractor continues to believe that it is entitled to additional money or time (including but not limited to grant of a time extension; payment of money or damages arising from work done by, or on behalf of, the Contractor, payment of which is not otherwise expressly provided for or the claimant is not otherwise entitled to; or an amount the payment of which is disputed by the City) based on an issue, then Contractor shall submit a Change Order Request ("COR") to City within twenty (20) days of (i) becoming aware of the issues creating a potential change, or (ii) the date by which it should have become aware of the issues creating a potential change. A rejection at any time or a lack of a rejection by City of a Notice of Potential Change does not affect the timeline for submitting a COR.

Failure to timely submit a COR related to an issue, or failure to comply with any of the COR requirements in the Contract shall constitute a complete waiver by Contractor of any right to later submit a COR or Claim on that issue, or to later pursue any additional money (including time extensions) in any manner related to that issue, regardless of the merits. Contractor will not have satisfied a condition precedent or exhausted administrative remedies.

The COR shall state the grounds for the additional money or time requested and the amount of money or time requested, and Contractor shall include all information supporting the COR.

Contractor shall certify the COR using the form set forth below for certification of a Claim, except that every reference to "Claim" shall be changed to "COR." If a COR is submitted without certification, a certification can still be submitted within the COR timelines set forth above. If the COR is not timely certified, Contractor will have completely waived its rights to any money or time for that issue, as Contractor will not have satisfied a condition precedent or exhausted administrative remedies.

The City may accept the entire COR, accept part of the COR and reject the remainder, reject the entire COR, or request additional information. If the City does not respond within thirty (30) days by accepting the entire COR, accepting part of the COR and rejecting the remainder, or requesting additional information, the entire COR shall be deemed rejected as of the thirtieth (30th) day. If the City requests additional information, then the Contractor shall submit the information within fifteen (15) days of the date of the request and the City shall have fifteen (15) days after the receipt of the additional information to accept or reject (in whole or in part) the COR. If the City fails to respond within fifteen (15) days after the submission of additional information, the entire COR shall be deemed rejected as of the fifteenth (15th) day.

Definition of Claim:

A "Claim" is a separate demand by the Contractor for (a) a time extension, including, without limitation, relief from damages or penalties for delay assessed by City, (b) payment of money or damages arising from work done by, or on behalf of, the Contractor, and payment of which is not otherwise expressly provided for or the claimant is not otherwise entitled to, or (c) an amount the payment of which is disputed by the City. A Claim includes any claim within the scope of Public Contract Code Section 20104 et seq. Resubmittal in any manner of a COR which was previously rejected (see above) constitutes a Claim, whether the COR was rejected in whole or in part, and whether the COR was rejected expressly or deemed rejected by City inaction. A Claim includes any dispute Contractor may have with the City, including one which does not require a Notice of Potential Change or COR (see above), and includes an alleged breach of contract by the City. A Claim shall also constitute a claim for purposes of the California False Claims Act. In the event of a conflict between a Claims provision in Division 1 of the Specifications and these provisions, these provisions shall take precedence.

The Notice of Potential Change and COR procedures above are less formal procedures which precede the more formal Claim. A Notice of Potential Change does not constitute a Claim. A COR does not constitute a Claim; **except that** if insufficient time remains before the Claim deadline (see below) for Contractor to submit a COR and for City to process and reject the COR (see above), then either (1) Contractor may submit a COR which City shall treat as a Claim, but only if the COR complies with all requirements, or (2) a COR is not required so long as a Claim complying with this Section 2-10 is timely submitted.

A Claim does not include vouchers, invoices, progress payment applications, or other routine or authorized forms of requests for progress payments on the Contract; however, those documents remain "claims" for purposes of the California False Claims Act. A Claim does not include a Government Code Claim. ("Government Code Claim" means a claim under Government Code Sections 900 et seq. and 910 et seq.)

Time for Submitting Claim:

Contractor shall submit a Claim to the City on or before the earlier of (a) 15 days after Completion of the Work or (b) the Contractor's submission of its date of the Final Progress Payment Application. City's rejection, or lack of rejection, of a COR at any time does not affect the deadline for filing a Claim.

In addition, on or before submitting its request for a final progress payment based on 100% Completion of the Work, Contractor shall submit to City, in writing, a summary of all Claims for money or time extensions under or arising out of this Contract which were timely filed and which were fully compliant with the Contract's requirements for Claims. This Claim summary requirement shall not extend the time for submitting a Claim.

Failure to timely submit a Claim, failure to include a Claim in the above Claim summary, or failure to comply with any of the Claim requirements in the Contract, including but not limited to this Section 2-10, will act as a complete waiver of Contractor's rights to (a) recover money or time on the issues for which a Claim was required, (b) submit a Government Code Claim for the money or time (see below), and (c) initiate any action, proceeding or litigation for the money or time, regardless of the merits, as Contractor will not have satisfied a condition precedent or exhausted administrative remedies. City does not have an obligation to reject the Claim for a failure to comply with any of the Claim requirements in the Contract, including the lack of certification; and any failure by City to reject, or any delay in rejecting, a Claim on that basis does not waive the City's right to reject the Claim on that basis at a later time. In no event may the Contractor reserve its rights to assert a Claim for a time extension or additional money beyond the timelines set forth in this provision unless the City agrees in writing to allow the reservation.

Content of Claim:

Every Claim shall be in writing. All money or time extensions sought must be stated and itemized in the Claim at the time submitted. The responsibility to substantiate Claims shall rest with the Contractor.

In addition, the Contractor shall include a certification with each and every Claim at the time of submission, as follows:

I, _____ [name of declarant], declare the following:

_____ [Contractor company name] has contracted with _____ [public entity name] for the _____ [name of Contract] Contract. _____ [Contractor company name] authorized me to prepare the attached Claim for money and/or time extension for _____ [public entity name] regarding this Contract (dated _____, 20__, titled _____, and requesting \$_____ and/or ___ additional days), and I prepared the attached Claim. I am the most knowledgeable person at _____ [Contractor company name] regarding this Claim.

The attached Claim complies with all laws applicable to submission of a Claim, including but not limited to California Penal Code Section 72, Government Code Section 12650 et seq. (False Claims Act), and Business and Professions Code Section 17200 et seq. (Unfair Business Practices Act). I am aware that submission or certification of false claims, or other claims that violate law or the Contract, may lead to fines, imprisonment, and/or other serious legal consequences for myself or _____ [Contractor company name].

The attached Claim does not breach the Contract, is not a false claim, does not violate any applicable law, satisfies all provisions of the Contract applicable to submission of the Claim, only contains truthful and accurate supporting data, and only requests money and/or time extensions that accurately reflect the adjustments to money and time for which I believe that [public entity name] is responsible under its Contract with _____ [Contractor company name].

While preparing this declaration and Claim, I consulted with others (including attorneys, consultants, or others who work for _____ [Contractor company name]) when necessary to ensure that the statements were true and correct.

Contractor understands and agrees that any Claim submitted without this certification does not meet the terms of the Contract Documents; that City, or City's representatives, may reject the Claim on that basis; and that unless Contractor properly and timely files the Claim with the certification, Contractor cannot further pursue the Claim in any forum and all rights to additional money or time for the issues covered by the Claim are waived due to a condition precedent not having been satisfied.

Pursuant to Public Contract Code Section 20104.2, Claims less than or equal to \$375,000 are subject to the following requirements.

Claims Less Than \$50,000

For Claims of less than fifty thousand dollars (\$50,000), the City shall respond in writing to any written Claim within 45 days of receipt of the Claim, or may request, in writing, within 30 days of receipt of the Claim, any additional documentation supporting the Claim or relating to defenses to the Claim the City may have against the Contractor.

If additional information is thereafter required, it shall be requested and provided pursuant to this subsection, upon mutual agreement of the City and Contractor. If City and Contractor cannot reach mutual agreement, Contractor's failure to provide any reasonably-requested information within fifteen (15) days after the request, shall act as a complete waiver of Contractor's rights to (a) recover money or time on the issues for which a Claim was required, (b) submit a Government Code Claim (see below) for the money or time, and (c) initiate any action, proceeding or litigation for such money or time. Contractor will not have satisfied a condition precedent or exhausted administrative remedies.

The City's written response to the Claim, as further documented, shall be submitted to the Contractor within fifteen (15) days after receipt of the further documentation, or within a period of time no greater than that taken by the Contractor in producing the additional information, whichever is greater.

Claims Over \$50,000, But Not Over \$375,000

For claims over fifty thousand dollars (\$50,000) and less than or equal to three hundred seventy-five thousand dollars (\$375,000), the City shall respond in writing to all written Claims within sixty (60) days of receipt of the Claim, or may request, in writing, within thirty (30) days of receipt of the Claim, any additional documentation supporting the Claim or relating to defenses to the Claim the City may have against the Contractor.

If additional information is thereafter required, it shall be requested and provided pursuant to this subsection, upon mutual agreement of the City and Contractor. If City and Contractor cannot reach mutual agreement, Contractor's failure to provide any reasonably-requested information within thirty (30) days after the request shall act as a complete waiver of Contractor's rights to (a) recover money or time on the issues for which a Claim was required, (b) submit a Government Code Claim (see section below) for such money or time, and (c) initiate any action, proceeding or litigation for such money or time. Contractor will not have satisfied a condition precedent or exhausted administrative remedies.

The City's written response to the Claim, as further documented, shall be submitted to the Contractor within thirty (30) days after receipt of the further documentation, or within a period of time no greater than that taken by the Contractor in producing the additional information or requested documentation, whichever is greater.

Meet and Confer

If the Contractor disputes the City's written response, or the City fails to respond within the time prescribed, the Contractor may so notify the City, in writing, either within fifteen (15) days of receipt of the City's response or within fifteen (15) days of the City's failure to respond within the time prescribed, respectively, and demand an informal conference to meet and confer for settlement of the issues in dispute. Upon a demand, the City shall schedule a meet and confer conference for settlement of the dispute, which shall take place within thirty (30) days of the demand. Upon written agreement of the City and Contractor, the conference may take place during regularly scheduled Project meetings.

If Contractor fails to timely notify the City that it wishes to meet and confer pursuant to the previous paragraph, then Contractor will have waived all rights to (a) recover money or time on the issues for which a Claim was required, (b) submit a Government Code Claim (see below) for such money or time, and (c) initiate any action, proceeding or litigation for such money or time. Contractor will not have satisfied a condition precedent or exhausted administrative remedies.

Government Code Claim

If the Claim or any portion remains in dispute after the meet and confer conference and Contractor wishes to pursue it, the Contractor **must** file a timely and proper Government Code Claim. The filing of a Government Code Claim is specifically required in addition to all contractual procedures above. The above contractual procedures do not act as a substitute for the Government Code Claim process, and the two sets of procedures shall be sequential with the contractual procedures coming first.

Failure to timely file a Government Code Claim shall act as complete waiver of Contractor's rights to (a) recover money or time on the issues for which a Government Code Claim was required, and (b) initiate any action, proceeding or litigation for such money or time. Contractor will not have satisfied a condition precedent or exhausted administrative remedies.

City and Contractor shall proceed with the Government Code Claim according to Government Code Section 900 et seq., and as otherwise permitted by law. For purposes of the applicable Government Code provisions, and as provided in Public Contract Code Section 20104.2(e), the running of the time period within which a Contractor must file a Government Code Claim shall be tolled from the time the Contractor submits a written Claim under the above provisions until the time that the Claim is denied, in whole or in part, as a result of the meet and confer process described above, including any period of time utilized by the meet and confer process.

Procedures for Claims over \$375,000:

Contractor and City shall proceed with Claims over \$375,000 pursuant to the above provisions for Claims of \$375,000 or less, **except as follows:** (a) the provisions regarding Claims under \$50,000 shall not apply; (b) the City shall respond in writing to all written Claims within 90 days of receipt of the Claim, or may request, in writing, within 45 days of receipt of the Claim, any additional documentation supporting the Claim or relating to defenses to the Claim the City may have against the Contractor; and (c) City shall respond within 45 days after receipt of the further documentation, or within a period of time no greater than that taken by the Contractor in producing the additional information or documentation, whichever is greater.

Mediation:

After the meet and confer process, the parties may agree to mediate, or use any other dispute resolution process, regarding any issues remaining in dispute. However, the mediation or dispute resolution process shall not affect the requirements and deadlines under law or this Contract, including submission of a Government Code Claim and filing a complaint.

Continuing Contract Performance:

Despite submission or rejection of a Notice of Potential Change, COR or Claim, the Contractor shall proceed diligently with performance of the Contract as directed by City, and the City shall continue to make any undisputed payments in accordance with the Contract.

Trenching More than Four Feet:

When any excavation or trenching extends greater than four feet (4') below the surface, the Contractor shall promptly, and before the following conditions are disturbed, notify the public entity, in writing, of any (1) material that the Contractor believes may be material that is hazardous waste, as defined in Section 25117 of the Health and Safety Code, that is required to be removed to a Class I, Class II, or Class III disposal site in accordance with the provisions of existing law; (2) subsurface or latent physical conditions at the site differing from those indicated by information about the site made available to bidders prior to the deadline for submitting bids; and (3) unknown physical conditions at the site of any unusual nature, different materially from those ordinarily encountered and generally recognized as inherent in work of the character provided for in the Contract.

The public entity shall promptly investigate the conditions, and if it finds that the conditions do materially so differ, or do involve hazardous waste, and cause a decrease or increase in the Contractor's cost of, or the time required for, performance of any part of the Work shall issue a change order under the procedures described in the Contract.

In the event that a dispute arises between the public entity and the Contractor whether the conditions materially differ, or involve hazardous waste, or cause a decrease or increase in the Contractor's cost of, or time required for, performance of any part of the Work, the Contractor shall not be excused from any deadline for Completion provided for by the Contract, but shall proceed with all Work to be performed under the Contract. The Contractor shall retain any and all rights provided either by Contract or by law which pertain to the resolution of disputes and protests between the contracting parties.

SECTION 3 CONTROL OF THE WORK

3-5 INSPECTION [Add the following:]

The Agency's supervision and inspection of the Work does not act as acceptance or agreement with any defective aspect of that Work, nor as a waiver of the Agency's claims against the Contractor regarding that Work. Responsibility for the quality of the Work is the Contractor's.

3-7.1 General [Replace the first paragraph with the following]:

The Contractor shall maintain a control set of Plans and Specifications on the project site at all times. All final locations determined in the field, and any deviations from the Plans and Specifications, shall be marked in red on this control set to show the as-built conditions. Upon Completion of all Work, the Contractor shall return the control set to the Engineer. Final payment will not be made until this requirement is met.

3-7.2 Precedence of the Contract Documents [Replace with the following:]

In the case of conflict between any of the Contract Documents, the order of precedence in Standard Specification Section 3-7.2(a)-(j) is amended as follows:

- (a) Permits issued by jurisdictional regulatory agencies.
- (b) Change Orders and Supplemental Agreements; whichever occurs last.
- (c) Contract/Agreement.
- (d) Addenda.
- (e) Contractor's Proposal (including Bid Sheet, subcontractor list, non-collusion declaration, bid bond, Iran Contracting Act Declaration, and Sufficient Funds Declaration).
- (f) Performance and Payment Bonds.
- (g) Notice Inviting Bids.
- (h) Instructions to Bidders.
- (i) Special Provisions.
- (j) General Provisions.
- (k) Project Plans.
- (l) Standard Plans.
- (m) General Specifications.
- (n) Standard Specifications (Greenbook).
- (o) Reference Specifications.
- (p) Workers Compensation Certification.

For any conflict in the Contract Documents not resolved by the above order of precedence, the more stringent, higher quality, and/or greater quantity of Work shall control. Detailed drawings shall take precedence over general drawings.

3-10 SURVEYING [Delete this section in its entirety and replace with the following]:

The Contractor shall provide surveying required to re-establish any survey monumentation disturbed by its work. The cost of surveying shall be the responsibility of the Contractor and shall be included in the various bid items of work.

3-12 WORK SITE MAINTENANCE

3-12.4.2 Storage in Public Streets. [Delete entire paragraph and replace with the following:]

No storage of equipment or materials shall be allowed within the public right-of-way outside of working hours.

The Contractor may, at his own expense, maintain and operate a work and storage area outside of the public right-of-way. In such case, the Contractor shall submit to Agency written authorization from the owners of the subject property prior to occupation. Occupation of site without written authorization shall be grounds for immediate suspension of work. Location of the site is to be approved by Agency. Condition and operation of yard shall conform to these Specifications. The Contractor shall assume full responsibility for all damage to the site resulting from his operations and shall repair and/or replace same, at his own expense, to the satisfaction of the owner of the subject property. The Contractor shall vacate site and return it to pre-project condition within five (5) working days following application for Notice of Completion. The Contractor shall obtain a written release from the property owner accepting the condition of the vacated site and releasing the Contractor from any further clean-up or restoration work and shall submit a copy of such release to Agency. The Notice of Completion will not be issued until said release is submitted.

3-13 COMPLETION, ACCEPTANCE, AND WARRANTY

3-13.2 Acceptance [Replace paragraph with the following:]

Only the Board may accept the Work as Complete. If, in the Engineer's judgment, the Contractor has fully performed the Contract, the Engineer will recommend to the Board that it accept the Contractor's performance of the Work as Complete.

On or within fifteen (15) days after acceptance by the Board, or sixty (60) continuous days of cessation of labor, whichever is earlier, the Agency may record a Notice of Completion.

3-13.3 Warranty [Add the following:]

Nothing contained in this Section 3-13.3 shall be construed to establish a period of limitation with respect to other obligations which the Contractor might have under the Contract Documents. Establishment of the time period of one (1) year relates only to the specific warranty obligation of the Contractor to correct the Work after the date of commencement of warranties, and has, for example, no relationship to the time within which the obligation to comply with the Contract Documents may be sought to be enforced by Agency, or to the time within which proceedings may be commenced by Agency to establish the Contractor's liability with respect to the Contractor's obligations other than specifically to correct the Work.

SECTION 4 CONTROL OF MATERIALS

4-4 TESTING [Add the following:]

The Agency will pay for inspection and materials testing. The Contractor shall pay for retests and re-inspections due to failure to meet specifications.

Testing Laboratory Services Furnished by the City:

The City shall pay all charges of testing laboratories for quality control tests made in the field or laboratory on concrete, asphalt mixtures, moisture-density (Proctor) and relative density tests on embedment, fill, and backfill materials, in-place field density tests on embedments and fills, and other materials and equipment, during and after their incorporation in the Work. Field sampling and testing will be performed by Engineer personnel, in the general manner indicated in the specifications, with minimum interference with construction operations. Engineer shall determine the exact time and location of field sampling and testing, and may require such additional sampling and testing as necessary to determine that materials and equipment conform with data previously furnished by Contractor and to the Contract Documents.

Arrangements for delivery of samples and test specimens to the testing laboratory will be made by the City. The testing laboratory shall perform all laboratory tests within a reasonable time.

Contractor shall furnish all sample materials and cooperate in the sampling and field testing activities, interrupting the Work when necessary. When sampling or testing activities are performed in the field by Engineer, Contractor shall furnish personnel and facilities to assist in the activities as required.

Transmittal of Test Reports:

Written reports of tests and engineering data furnished by Contractor for Engineer's review of materials and equipment proposed to be used in the Work shall be submitted as specified for Shop Drawings.

The testing laboratory retained by the Engineer will furnish three copies of a written report of each test performed by laboratory personnel. Two copies of each test report will be transmitted to the Engineer and one copy to the Contractor within three (3) working days after each test is completed.

SECTION 5 LEGAL RELATIONS AND RESPONSIBILITIES

5-3 LABOR

5-3.1 General [Add the following:]

The Contractor, and all subcontractors, suppliers, and vendors shall comply with applicable Agency, State, and Federal orders regarding affirmative action to ensure equal employment opportunities and fair employment practices. Failure to file any report due under said orders will result in suspension of periodic progress payments. The Contractor shall ensure unlimited access to the Job site for all equal employment opportunity compliance officers.

This Contract is subject to compliance registration, monitoring and enforcement by the Department of Industrial Relations (DIR) and all related requirements of Senate Bill 854 (Labor Code Sections 1715.5, 1725.5, 1771.1, 1771.1a and 1771.4.)

Contractor is responsible for employing apprentices as required by Section 1777.5 of the Labor Code and all other law.

Pursuant to Section 6109(a) of the Public Contract Code, Contractor may not perform the Work with a subcontractor that is ineligible pursuant to Labor Code Section 1777.1 or 1777.7.

A contractor or subcontractor shall not be qualified to submit a bid or to be listed in a bid proposal subject to the requirements of Public Contract Code Section 4104, nor shall it be qualified to enter into, or engage in the performance of, any contract of public work, unless it is currently registered and qualified under Labor Code Section 1725.5 to perform public work (as "public work" is defined by Division 2, Part 7, Chapter 1 (Section 1720 et seq.) of the Labor Code).

5-3.3 Payroll Records. [Add the following:]

Payroll records shall be submitted to the Agency at least once each month. Progress payments will be withheld pending receipt of any outstanding reports.

5-4 INSURANCE [See Instructions to Bidders:]

5-4.1 General [Add the following paragraphs:]

The Contractor shall defend, indemnify and save harmless the City of Mission Viejo, the State of California, the County of Orange, or any incorporated city from all claims or suits for damages arising from his prosecution of the Contract Work. The Agency shall give timely notification to Contractor of the receipt of any third-party claim relating to the contract.

All liability insurance policies shall bear an endorsement or shall have attached a rider whereby it is provided that, in the event of expiration or proposed cancellation of such policies for any reason whatsoever, the Agency shall be notified by registered mail, return receipt requested, giving a sufficient time before the date thereof to comply with any applicable law or statute, but in no event less than thirty (30) days before expiration or cancellation is effective. The following statement shall be included on all insurance policies:

Additional Insured: The insurer agrees that the City of Mission Viejo and its City Council and/or all City Council-appointed groups, committees, boards, and any other City Council-appointed body and/or elective and appointive officers, servants, or employees of the City, when acting as such, are additional insured hereunder for the acts of the insured and such insurance shall be primary to any insurance of the City.

The Contractor agrees to protect, defend, and indemnify the City of Mission Viejo against loss, liability, damage, or expense by reason of any suit claims, demands, judgments and causes of action caused by the Contractor, his employees, agents, or any subcontractor, or by any third party arising out of or in consequence of the performance of all or any operations covered by Contractor's policies. The Contractor, at his option, may include such coverage under his Public Liability coverage.

5-4.2 General Liability Insurance [Add the following:]

The City of Mission Viejo, the City Council, and the Engineer shall not be answerable or accountable in any manner for any loss or damage that may happen to the Work or any part thereof; or for any of the materials or other things used

or employed in performing the Work; or for injury to any person or persons, either workmen or the public or for damage to any person or persons either workmen or the public; or for damage to adjoining property from any cause which might have been prevented by the Contractor, or his workmen, or anyone employed by him; against all of which injuries or damages to persons and property the Contractor, having control over such work, must properly guard.

The Contractor shall be responsible for any damage to any person or property resulting from defects and/or obstructions at any time before Completion and final acceptance of the Work and shall indemnify and save harmless the City of Mission Viejo, the City Council, and the Engineer from all suits or actions of every name and description brought for, or on account of, any injuries or damages received or sustained by any person or persons, by the Contractor, his servants or agents, in the construction of the Work or in consequence of any negligence in guarding the same, in improper materials used in its construction, by or on account of any act or omission of the Contractor or his agents, and so much of the money due the Contractor under and by virtue of the Contract as shall be considered necessary by the City may be retained by the City until disposition has been made of such suits or claims for damages aforesaid.

If, in the opinion of the Engineer, the precautions taken by the Contractor are not safe or adequate at any time during the life of the Contract, the Engineer may order the Contractor to take further precautions; and if the Contractor shall fail to do so, the Engineer may order the Work done by others and charge the Contractor for the cost thereof, and such cost to be deducted from any moneys due or becoming due the Contractor. Failure of the Engineer to order such additional precautions, however, shall not relieve the Contractor from his full responsibility for public safety or its obligations under the Contract.

From time to time, during the period of this Contract, the City may be served with claims, as a result of conduct by Contractor, which claims are for property damage or other damage in amounts of \$500.00 or less. These claims may be resolved informally by City, within City's discretion, and charged back against Contractor by funds held in retention, or for progress payments, to meet these claims. The City will appoint a Claims Administrator who will act on behalf of the City and Contractor. The Administrator will recommend to City the resolution of any claim. The Claims Administrator's recommendation for payment shall be paid by Contractor within thirty (30) days of the date of the recommendation. If Contractor fails to make payment to claimant within thirty (30) days of the Administrator's decision, the City may make payment to the claimant and withhold, as retention, sufficient funds to reimburse City upon Completion of the Contract. Prior to making his recommendation, the Administrator will obtain from Contractor all evidence relevant to the claim. Contractor will have ten (10) days from the date requested by the Administrator to submit any evidence in the defense of the claim. Failure to do so waives any objection by Contractor to payment of the claim if, after an independent investigation, it is the opinion of the Administrator to make payment of that claim.

SECTION 6 PROSECUTION AND PROGRESS OF THE WORK

6-1 CONSTRUCTION SCHEDULE AND COMMENCEMENT OF THE WORK

6-1.1 Construction Schedule [Replace the first sentence with the following:]

The Contractor's proposed baseline construction schedule shall be submitted to the City within ten (10) working days after the date of the Notice of Award of Contract. The schedule shall be supported by written statements from each supplier of materials or equipment indicating that all orders have been placed and acknowledged and setting forth the dates that each item will be delivered.

Prior to issuing the Notice to Proceed, the City will schedule a pre-construction meeting with the Contractor to review the proposed construction schedule and delivery dates, arrange the utility coordination, discuss construction methods, and clarify inspection procedures.

The Contractor shall submit periodic progress reports to the City by the tenth (10th) day of each month. The report shall include an updated construction schedule showing as-built schedule for Completed Work and as-planned schedule for remaining Work. Any deviations from the original schedule shall be explained. Progress payments will be withheld pending receipt of any outstanding reports.

6-2 PROSECUTION OF THE WORK

[Replace the first sentence the following:]

To minimize public inconvenience and possible hazard and to restore street and other work areas to their original condition and state of usefulness as soon as practicable, the Contractor shall diligent prosecute the Work to completion and ensure that the construction of ARHM overlay for any given portion of the roadway is completed no later than two (2) working days following the cold-milling of the same portion of roadway.

6-3 TIME OF COMPLETION

6-3.1 General [Add the following:]

The time for Completion shall be as set forth in the General Specifications.

6-4 DELAYS AND EXTENSIONS OF TIME

6-4.1 General [Add the following to the end of this section:]

No time extension shall be granted unless the claimed delay meets each and every of the following conditions:

- (a) The delay was caused by unforeseen events and was beyond the control of Contractor and its subcontractors and material suppliers;
- (b) The delay was caused by events of which Contractor was not advised at or before the time of bidding;
- (c) The delay impacted and delayed (i) the controlling items of Work (i.e., the as-built critical path, as determined from the as-planned schedule and the actual progress of the Work), or (ii) the Completion of the whole Work within the Contract time;
- (d) The delay was not caused by Contractor or its subcontractors or suppliers, including but not limited to their breaches of contract or the standard of care;
- (e) The delay was not associated with loss of time resulting from the necessity of submittals to Agency for approval, or from necessary Agency surveys, measurements, inspections and testing;
- (f) The delay was not caused by usual or common weather for the time of year, including usual or common severe weather; and
- (g) The delay could not have been prevented by the exercise of care, prudence, foresight, and diligence by Contractor.

Excusable delays may include acts of God, acts of public enemy, acts of the Owner or anyone employed by it, acts of another contractor in performance of a contract (other than this Contract) with the Agency, fires, floods, epidemics, quarantine restrictions, labor disputes, unusually and uncommonly severe weather for the time of year, unforeseen site conditions, or delays of subcontractors due to such causes. Agency shall take into consideration other relevant factors such as concurrent delays.

Contractor has the burden of proving that any delay was excusable, including but not limited to an analysis that establishes no concurrency.

No extension of time will be granted for an excusable delay caused by a shortage of materials unless the Contractor furnishes to the Engineer documentary proof that the Contractor has made every effort to obtain the materials from all known sources within reasonable reach of the Work in a diligent and timely manner, and further proof in the form of supplementary progress schedules that the inability to obtain the materials when originally planned did in fact cause a delay in final Completion of the entire Work which could not be compensated for by revising the sequence of the Contractor's operations. The term "shortage of materials" shall apply only to materials, articles, parts or equipment which are standard items and are to be incorporated in the Work. The term "shortage of materials" shall not apply to materials, parts, articles or equipment which are processed, made, constructed, fabricated or manufactured to meet the specific requirements of the contract. Only the physical shortage of material will be considered under these provisions as a cause for extension of time. Delays in obtaining materials due to priority in filling orders will not constitute a shortage of materials.

6-4.3 Payment for Delays [Replace paragraph with the following:]

To be compensable, an excusable delay must be one for which the Agency is responsible, where the delay was unreasonable under the circumstances involved, and where the delay was not within the contemplation of the parties; **however**, Contractor shall not be entitled to monetary compensation when (a) Contractor could have reasonably anticipated the delay and avoided or minimized the cost impacts of it, such as judicious handling of forces, equipment, or plant, (b) there was a concurrent delay which does not qualify for monetary compensation under this paragraph, (c) the cause of the delay was reasonably unforeseen by the Agency or the delay was caused by factors beyond the control of the Agency, including but not limited to a delay under Section 6-4.1 above or a delay caused by a utility company's failure to perform despite Agency's reasonable arrangements for such performance; or (d) any other defense available to Agency under law or equity applies. Contractor has the burden of proving that any delay was excusable and compensable, including an analysis that establishes non-concurrency.

The Contractor may not seek damages for delay of a planned Completion of the Work before the contractual deadline for Completion of the Work.

6-7 TIME OF COMPLETION.

6-7.1 General. [Add the following]:

The time for completion shall be as set forth in the General Specifications.

6-7.2 Working Day. [Add the following]:

The Contractor's activities shall be confined to the hours between 8:30 a.m. and 4:30 p.m., Monday through Friday, excluding holidays on Working Days. Deviation from these hours will not be permitted without the prior written consent of City, except in emergencies involving immediate hazard to persons or property or the reprogramming of Portable Changeable Message Signs. In the event of either a requested or emergency deviation, inspection service fees will be charged against the Contractor. The service fees will be calculated at overtime rates, including benefits, overhead, and travel time. The service fees will be deducted from any amounts due the Contractor.

6-8 TERMINATION OF THE CONTRACT FOR CONVENIENCE

[Replace the first sentence with the following:]

The Board may terminate the Contract for any reason at any time.

[Replace the last two sentences with the following:]

If the Contractor disagrees with the amount determined by the Agency, the Contractor shall follow all procedures of Section 6-2, above.

6-9 LIQUIDATED DAMAGES [Replace last sentence of first paragraph with the following:]

For each calendar day the Work is not Complete in excess of the time specified in the Contract for Completion of the Work, as adjusted in accordance with Subsection 6-4, the Contractor shall pay to the Agency, or have withheld from moneys due it, the sum of Twenty-Five Hundred Dollars (\$2,500.00).

The first coat of striping and pavement markings for any given portion of the roadway shall be placed no more than three calendar days following the ARHM Overlay. For each calendar day the striping is not applied following the three calendar days, the Contractor shall pay to the Agency, or have withheld from moneys due it, the sum of Three Thousand Dollars (\$3,000.00).

The contractor shall re-install all traffic signal loops as per the attached plans no more than five calendar days of the completion of the ARHM overlay. For each calendar day the traffic signal loops are not installed following the five calendar days, the Contractor shall pay to the Agency, or have withheld from moneys due it, the sum of Three Thousand Dollars (\$3,000.00).

[Replace first sentence of the last paragraph with the following:]

Execution of the Contract shall constitute agreement by the Agency and Contractor that Two Thousand and Five Hundred Dollars (\$2,500.00) per day is the minimum value of the costs and actual damage caused by the failure of the Contractor to Complete the Work within the allotted time.

SECTION 7 MEASUREMENT AND PAYMENT

7-3 PAYMENT

7-3.1 General [Replace last paragraph with the following:]

Agency shall release retention to Contractor pursuant to Public Contract Code Section 7107, which requires, among other things, that retention be released within sixty (60) days after Completion of the Work.

The Agency may withhold from a progress payment or release of retention, in whole or in part, to such extent as may

be necessary to protect the Agency due to any of the following:

- A. Defective or incomplete Work not remedied;
- B. Stop Payment Notices. For any stop payment notice given to the Agency, the Agency shall withhold the amount stated in the stop payment notice, the stop notice claimant's anticipated interest and court costs and an amount to provide for the public entity's reasonable cost of any litigation pursuant to the stop payment notice. For any stop payment notice action the parties resolve before judgment is entered, Agency has the right to permanently withhold for any reasonable cost of litigation for that stop payment notice, even if it exceeds the amount originally withheld by Agency for the estimated reasonable cost of litigation. However, if (1) the Contractor at its sole expense provides a bond or other security satisfactory to the Agency in the amount of at least one hundred twenty-five percent (125%) of the claim, in a form satisfactory to the Agency, which protects the Agency against such claim, and (2) the Agency chooses to accept the bond, then Agency would release the stop payment notice funds withheld to the Contractor, except that Agency may permanently withhold for any reasonable cost of litigation. Any stop payment notice release bond shall be executed by a California-admitted, fiscally solvent surety, completely unaffiliated with and separate from the surety on the payment and performance bonds, that does not have any assets pooled with the payment and performance bond sureties;
- C. Liquidated damages against the Contractor, whether already accrued or estimated to accrue in the future;
- D. Reasonable doubt that the Work can be Completed for the unpaid balance of any Contract Sum or by the Completion deadline;
- E. Damage to the property or work of the Agency, another contractor, or subcontractor;
- F. Unsatisfactory prosecution of the Work by the Contractor;
- G. Failure to store and properly secure materials;
- H. Failure of the Contractor to submit on a timely basis, proper and sufficient documentation required by the Contract Documents, including, without limitation, monthly progress schedules, shop drawings, submittal schedules, schedule of values, product data and samples, proposed product lists, executed change orders, and verified reports;
- I. Failure of the Contractor to maintain as-built or record drawings;
- J. Erroneous estimates by the Contractor of the value of the Work performed, or other false statements in an Application for Payment;
- K. Unauthorized deviations from the Contract Documents;
- L. Failure of the Contractor to prosecute the Work in a timely manner in compliance with established progress schedules and Completion deadlines;
- M. Subsequently discovered evidence or observations nullifying the whole or part of a previously issued Certificate for Payment;
- N. Failure by Contractor to pay subcontractors or material suppliers as required by Contract or law, which includes but is not limited to Contractor's failure to pay prevailing wage and any assessment of statutory penalties;
- O. Overpayment to Contractor on a previous payment;
- P. Credits owed to Agency for reduced scope of Work or Work that Contractor will not perform;
- Q. The estimated cost of the Agency's performance of corrective Work;
- R. Actual damages related to false claims by Contractor;
- S. Breach of any provision of the Contract Documents;
- T. Agency's potential or actual loss, liability, or damages caused by the Contractor; and

- U. As permitted by other provisions in the Contract or as otherwise allowed by law, including statutory penalties Agency or other entities assessed against Contractor. (See e.g., Labor Code Section 1813 (working hours) or Public Contract Code Section 4110 (subcontractor listings and substitutions)).

Agency may, but is not required to, provide to Contractor with the progress payment written notice of the items for which Agency is withholding amounts from the payment. To claim wrongful withholding by the Agency, or if Contractor otherwise disputes any amount being withheld, Contractor must submit an inquiry in writing to Agency within thirty (30) days of receipt of the notice, and Agency shall respond within fifteen (15) days of receipt of the inquiry. If any disputed issues remain unresolved after Agency's response, Contractor shall timely submit a Claim pursuant to Section 2-10, above.

For any withhold amount based on an estimate where the actual amount will later become known and certain, the Owner may withhold 125% of the estimate. After the actual amount becomes known, if that actual amount exceeds the amount previously withheld, Agency may withhold additional amounts from Contractor to cover the excess amount; and if available funds are not sufficient, Contractor shall pay Agency the difference. After the actual amount becomes known and certain, if that amount is less than the amount previously withheld, the Agency will pay and release any amount withheld over that certain and known amount.

When Contractor removes or cures the grounds for withholding amounts, payment shall be made for amounts withheld because of them. No interest shall be paid on any retainage or amounts properly withheld by the Agency.

Neither Agency's overpayment to Contractor, nor Agency's failure to withhold an amount from payment that Agency had the right to withhold, shall constitute a waiver by Agency of its rights to withhold those amounts from future payments to Contractor or to otherwise pursue recovery of those amounts from Contractor.

Pursuant to and in accordance with the provisions of Government Code Section 8546.7, or any amendments thereto, all books, records, and files of the Agency, the Contractor, or any Subcontractor connected with the performance of this Contract involving the expenditure of State funds in excess of Ten Thousand Dollars (\$10,000.00), including, but not limited to, the administration thereof, shall be subject to the examination and audit of the Office of the Auditor General of the State of California for a period of three (3) years after release of all retention under this Contract. Contractor shall preserve and cause to be preserved such books, records, and files for the audit period. During the progress of the Work and for three (3) years after release of all retention under the Contract, Agency shall also have the right to an audit, and Contractor must cooperate by producing all information requested within seven (7) days.

7-3.2 Partial and Final Payment [Replace the last paragraph with the following:]

The final progress payment will not be released until the Contractor returns the control set of Plans and Specifications showing the as-built conditions.

In conformance with the State of California Government Code, Chapter 13, Section 4590, the Contractor may substitute securities for any moneys withheld by the Agency to secure performance under the contract.

Within thirty (30) days after receipt of an undisputed and properly submitted Application for Payment, Contractor shall be paid by Agency.

7-3.3 Delivered Materials [Replace with the following:]

Materials and equipment delivered but not incorporated into the Work will not be included in the estimate for progress payment, unless specifically approved by the agency.

7-3.4 Mobilization [Replace with the following:]

Mobilization shall consist of all preparatory work and operations, including but not limited to those necessary for the movement of personnel, equipment, supplies, and incidentals to the project site; for the establishment of all offices, buildings and other facilities necessary for the Work on this project; and for all other work and operations which must be performed or cost incurred prior to the beginning Work on the various contract items on the project site.

The lump sum price paid for mobilization shall include full compensation for all costs incurred by the Contractor for doing all the work involved in mobilization as specified herein including all construction site safety, i.e., temporary chain-link fencing, signage, etc. Payment for mobilization shall be included in the lump sum price bid for mobilization and no additional compensation will be allowed therefore.

7-4 PAYMENT FOR EXTRA WORK

7-4.3 Markup

7-4.3.1 Work by the Contractor [Add the following:]

The markups mentioned hereinafter shall include, but are not limited to, all costs for the services of superintendents, project managers, timekeepers, and other personnel not working directly on the change order and pickups or yard trucks used by the above personnel. These costs shall not be reported as labor or equipment elsewhere except when actually performing Work directly on the change order and then shall only be reported at the labor classification of the Work performed.

7-4.3.2 Work by a Subcontractor [Add the following:]

The markups mentioned hereinafter shall include, but are not limited to, all costs for the services of superintendents, project managers, timekeepers, and other personnel not working directly on the change order and pickups or yard trucks used by the above personnel. These costs shall not be reported as labor or equipment elsewhere except when actually performing Work directly on the change order and then shall only be reported at the labor classification of the Work performed.

PART 2—CONSTRUCTION MATERIALS

SECTION 200 ROCK MATERIALS

200-1 ROCK PRODUCTS.

200-1.1 General. [Add the following:]

Unless otherwise indicated by the Special Provisions, Alternate Rock Material Type "S" is specified. Part 4, Section 400, of the Standard Specifications for Public Works Construction will be used, as modified by Orange County Public Works Standard Plan 1804.

200-1.4 Coarse Aggregate for Portland Cement Concrete

1. Non-Slip Aggregate: Fused aluminum oxide grits or crushed emery, factory graded, packaged rust proof.

Payment. [Add the following:]

Payment for rock materials shall be included in the unit bid item price for those pertinent construction items, i.e., concrete walks, ramps.

SECTION 201 CONCRETE, MORTAR, AND RELATED MATERIALS.

201-1 PORTLAND CEMENT CONCRETE.

201-1.1 Requirements. [Add the following:]

201-1.1.1 General. The following paragraph shall be added following paragraph 4:

The cement utilized shall be Type V. No substitution of materials shall be permitted. The Contractor shall furnish the City's Representative with a copy of the mix design to be used and with a legible certified weight-master's certificate for each load of P.C.C. delivered to the project. Portland Cement Concrete delivered to the project site having a water content and/or slump greater than that specified in the mix design shall be rejected and removed from the project site.

201-1.1.2 Concrete Specified by Class and Alternate Class. [Add the following:]

The class of concrete shall be 520-C-2500 with a maximum slump of four inches (4") for all sidewalks, access ramps, curbs and gutters, and driveways.

201-1.1.5 Tests. [Add the following:]

1. All material shall comply with Orange County Standards and American Concrete Institute (Act I) and Uniform Building Code.
2. Product Data
 - a. Submit complete materials list of items proposed for the work. Identify materials source.
 - b. Submit admixture, curing compound, retarder, and accessory item product data.
 - c. Submit material certificates for aggregates, reinforcing, and joint fillers.
3. Submit concrete delivery tickets. Show the following:
 - a. Batch number
 - b. Mix by class or sack content with maximum size aggregate
 - c. Admixture
 - d. Air content
 - e. Slump
 - f. Time of loading
4. Submit concrete test reports.
5. Provide field quality control testing and inspection during concrete operations.

6. Contractor shall provide adequate notice, cooperate with, provide access to the work, obtain samples, and assist test agency and their representatives in execution of their function.

7. Testing

- a. Provide slump test on first load of concrete delivered each day and whenever requested due to changes in consistency or appearance of concrete.
- b. Provide air indicator tests and air meter tests for all air-entrained concrete.
 - 1) Perform air indicator test with a "Chase" AE 35 or equal air indicator and air meter test in accordance with ASTM C231 or C173. Test first load of concrete delivered each day.
 - 2) Furnish copies of field records and test reports as listed for strength tests.
- c. Strength Testing
 - 1) Provide one set of three test specimens for each 50 cubic yards placed in any one day. Secure samples in accordance with ASTM C31.
 - 2) Test one specimen at 7 days and two specimens at 29 days in accordance with ASTM C39.
 - 3) Furnish copies of field records and test reports as follows:
 - 2 copies to City's representative
 - 1 copy to Contractor
 - 1 copy to Ready Mix supplier
- d. Record the exact location of the concrete in the work represented by each set of cylinders and show on test reports.
- e. Provide an insulated moist box for protection of the best cylinders until shipped to the laboratory.

201-1.2 Materials.

201-1.2.1 Portland Cement. [Add the following:]

- 1. Lime: ASTM C207, Type S, containing 85% by weight of calcium oxide.
- 2. Lime Putty: Make from hydrated lime conforming to ASTM C207, pulverized to such fineness that 100% will pass a 50-mesh sieve. Mix lime in water, run through screen into box, and age 48 hours.

201-1.4 Mixing.

201-1.4.3 Transit Mixers. [Add the following:]

Mixes

- a. Provide ASTM C94 ready-mixed concrete. Batch mixing at site is not acceptable.
 - 1. Strength: 2,500 psi minimum at 28 days for all concrete flatwork, curbs, plaza area, etc.
- b. Provide an approved water-reducing admixture in all concrete.
- c. Provide an air-entraining admixture in all concrete. Air content 5% to 7%.
- d. Indicate water added to mix at job site on each delivery ticket. Show quantity of water added. Site water-tempered mixes exceeding specified slump range will be rejected as not complying with specifications requirements.

201-2 REINFORCEMENT FOR CONCRETE

201-2.2 Steel Reinforcing. [Add the following paragraph immediately after the first paragraph:]

#4 reinforcing steel shall be 40-grade.

201-3 EXPANSION JOINT FILLER.

Premolded joint filler material. Type to be determined by City's recommendation. Provide in natural gray color.

SECTION 202 MASONRY MATERIALS

202-2 CONCRETE BLOCK

202-2.1 General: [Add the followings:]

1. Codes: Materials and work shall conform to the governing building code. In case of conflict between the codes, the more stringent shall govern.
2. Samples: In accordance with the sections and details for the raised planters, submit samples of all blocks used in the work.
3. Protection: Safeguard all materials against injury in transit, delivery, storage, sorting, installation, cleaning, and until final acceptance of the completed work. Store cement and lime in rainproof sheds with elevated floors. Store sand on tightly floored space, protected against mixing with ground or other materials.
4. Quality of construction is the responsibility of the Contractor.

202-2.2 Masonry Units [Add the following:]

The concrete blocks shall conform to the requirements shown on the plans and shall be nominal size and of uniform color. Concrete block type and color are as specified on the plans and are available from ORCO BLOCK 714-527-2239, or approved equal.

Sealants. "All guard" concrete masonry sealer as manufactured by Dow Corning, or approved equal.

Waterproofing. Waterproofing membrane (Miradri 860) and protective membrane (Miradri Protection Course 200V) as manufactured by Nicolon Mirafi, or approved equal.

202-3 MORTAR, GROUT, AND WATER

202-3.1 Mortar

202.3.1.1 General [Add the following:]

Mortar for laying masonry units shall consist, by volume, of 1 part Portland cement, ½-part lime putty, 3 parts sand, and shall conform to ASTM C270. If plastic type cement is used, the lime putty shall be omitted. Each batch of mortar shall be freshly prepared and uniformly mixed.

Mortar shall be colored to match the units. Coloring shall be chemically inert, fade resistant mineral oxide, or synthetic type.

202-3.2 Grout

202-3.2.1 General [Replace with the following:]

Grout for filling masonry units shall consist, by volume, of 1 part Portland cement and 3 parts sand, or 1 part Portland cement, 3 parts sand, and 2 parts pea gravel. Sufficient water shall be added to create grout of fluid consistency. Grout shall be natural in color.

Pea Gravel. Clean, hard, containing not more than 5% by weight of flat, thin, elongated, friable, or laminated pieces; uniformly graded with not over 5% passing a no. 8 sieve to 100% passing a 3/8" sieve.

Lime. ASTM C207, Type S, containing 85% by weight of calcium oxide.

Lime Putty. Make from hydrated lime conforming to ASTM C207, pulverized to such fineness that 100% will pass a 50-mesh sieve. Mix lime in water, run through screen in to box, and age 48 hours.

Mortar and grout not used within 30 minutes after leaving mixer will not be permitted on the work. Retempering of mix will not be allowed.

SECTION 203 BITUMINOUS MATERIALS

203-6 ASPHALT CONCRETE.

203-6.1 General. [Add the following:]

Remove and replace asphalt concrete shall be at various locations as shown on the plans and as directed by the City Inspector, and shall conform to the provisions in Subsection 300-1.3, "Removal and Disposal of Materials," of Standard Specifications and these Special Provisions.

The City's Inspector will designate and mark the final limits immediately prior to construction. The field marked areas shall be considered to take precedence over the areas shown on the plans. No guarantee is made that the final quantities will equal quantities listed in the proposal.

The areas indicated for removal and replacement shall be removed to a minimum depth of four inches (4"). Where directed by the City Inspector, additional depth of asphalt shall be removed. No adjustment in the unit bid price will be made for areas where the City's Inspector directs the Contractor to remove and replace asphalt to a greater depth.

Asphalt pavement shall be removed to clean straight lines before replacement to insure that all areas are accessible to equipment used to compact replacement materials. All materials removed shall be disposed of.

Prior to placement of asphalt concrete, a tack coat of SS-1H emulsified asphalt shall be uniformly applied to all contact surfaces at a rate of 0.05 gallon per square yard.

Asphalt concrete used for replacement of the existing pavement shall be III-B2-PG 64-10.

Asphalt Concrete Pavement mix designs shall not contain more than 15% Reclaimed Asphalt Pavement (RAP).

Following the asphalt placement, the Contractor shall roll the entire patch in both directions covering the patch at least twice. Hand broom to remove all loose and excess material from patch and surrounding area.

Payment for "Remove Existing Asphalt To A Depth of 4" And Re-Pave With 4" Thick AC Base Course" will be made at the Contract unit price per CUBIC FOOT, which shall include full compensation for furnishing all labor, tools, equipment, grinding or removal of existing asphalt, and incidentals required for removal and disposal of pavement, tack coat and placement of new asphalt pavement in accordance with these Special Provisions and no additional compensation will be allowed therefore.

Composition and Grading

The Contractor shall submit a Job Mix Formula (JMF) for review by the City for each source of supply and type of mixture specified. The JMF shall indicate the percentage aggregate passing each specified sieve size and the percent paving asphalt to be used for each asphalt concrete mixture incorporated in the work.

The aggregate and paving asphalt portions of the mixture produced shall not vary from the JMF by more than the tolerances, which follow, but in any case the allowed tolerance is also restricted to conform to the master grading ranges.

<u>Sieve Size</u>	<u>Percent by Weight</u>
No. 4 and larger	±6
No. 30	±5
No. 200	±2
Paving Asphalt Material	±0.3

Sampling and Testing

The City Engineer shall have the right to obtain samples of all materials to be used in the work and to test such samples for the purpose of determining specification compliance. The primary sampling point by the testing laboratory will be at the project at the paving machine ahead of all rollers. Other testing may be at the job site, plant, or in trucks as determined by the City Engineer.

Materials that failed the tests shall be replaced by the Contractor, and retesting for specifications compliance shall be at the Contractor's expense.

The aggregate and mix to be incorporated into the work shall conform to the following quality requirements:

Test

Loss in LA Rattler per California Test 211 (after 500 revolutions)
Sand Equivalent per California Test 217
Stabilometer Value per California Test 366
Air Voids Content (mix) %

Test Results

45% maximum
45 minimum
35 minimum
3% minimum to 5% maximum

203-11 ASPHALT RUBBER HOT MIX (ARHM).

203-11.2.3 Crumb Rubber Modifier (CRM)

203-11.2.3.1 General. [Replace the entire first paragraph as follows:]

CRM shall only consist of California-generated waste tires, processed in California, and shall conform to the chemical analysis requirements shown in Table 203.11.2.3.1 (A). High natural CRM shall NOT be used on this project, and any references to high natural CRM in the Greenbook specifications shall not apply. Asphalt rubber binder shall contain a minimum of 300 pounds (equivalent to 15 percent by weight) of tire-derived crumb rubber per ton of rubberized binder. The binder may be either asphalt rubber/field blend or terminal blend. A Certificate of Compliance shall be furnished to the Engineer prior to construction containing a statement confirming conformance with these requirements.

203-11.3 Composition and Grading. [Add the following:]

Asphalt-rubber hot-mix-gap-graded (ARHM-GG) shall be Class C (ARHM-GG-C).

SECTION 210 PAINT AND PROTECTIVE COATINGS

210-1 PAINT.

210-1.4 Paint Materials. [Add the following:]

Submittals

1. Materials List:

- a. The Contractor shall furnish the articles, equipment, materials, or processes specified by name in the drawings and specifications. No substitution will be allowed without prior written approval of the City.
- b. Complete material list shall be submitted prior to performing work. Material list shall include the manufacturer, model number, and description of all materials and equipment to be used.
- c. Equipment or materials installed or furnished without prior approval of the City may be rejected and the Contractor required to remove such materials from the site at his own expense.
- d. Approval of any item, alternate, or substitute indicates only that the product or products apparently meet the requirements of the drawings and specifications on the basis of the information or samples submitted.

SECTION 211 MATERIAL TESTS

211-1 COMPACTION TESTS

211-1.1 Laboratory Maximum Density [Replace with the following:]

Laboratory maximum density tests shall be performed in accordance with Test Method No. Calif. 216G, Part II. The correction for oversized material as stated in Test Method No. Calif. 216 shall be replaced with Note 2 of ASTM D1557.

Proposed off-site fill material shall be inspected, tested and laboratory report issued prior to use in the work. Suitable excavated materials removed to accommodate new construction may be used as fill material subject to Soils Engineer's inspection and approval.

211-1.2 Field Density [Add the following:]

Field density tests will be made by a certified testing laboratory during the course of construction at the expense of the Agency. If field density tests indicate that any portion of the compacted subgrade has density lower than that specified, the Contractor shall rework that portion until the specified density is obtained.

Retest of areas which have failed compaction will be performed by a certified testing laboratory at the Contractor's expense. Fill material within concrete paving areas shall be compacted to 90% relative compaction. Aggregate base under asphalt concrete shall be compacted to 95% relative compaction.

Payment. [Add the following to this section]:

Payment for soils and aggregate tests shall be included in the unit bid price item for all related items (i.e., retest, etc.).

SECTION 214 TRAFFIC STRIPING, CURB AND PAVEMENT MARKINGS, AND PAVEMENT MARKERS

214-6 Pavement Markers

214-6.2.3 Reflectance. [Add the following:]

The description, type, sampling, tolerances, packaging, and storage of reflective and non-reflective pavement markers and bituminous adhesive shall conform to the California Department of Transportation Standard Specifications Section 81-3 "Pavement Markers".

Epoxy adhesive, if used, shall conform to the California Department of Transportation Standard Specification Section 95 "Epoxy".

PART 3—CONSTRUCTION METHODS

300-1 CLEARING AND GRUBBING

300-1.2 Root Pruning and Tree Trimming. [Add the following:]

Areas that are to be repaired due to tree roots.

1. Cut tree roots along all edges of concrete removal area.
2. Tree roots shall not be cut up to the base of the trunk.
3. Cuts shall be four inches (4") wide, eighteen inches (18") deep as measured from the top of the new sidewalk.
4. All tree root cutting will be directed by the City Inspector.

Root pruning equipment shall be specifically designed for this purpose, sharpened adequately to sever roots in a clean manner, and equipped with padded tracks or rubber tires to prevent scraping or marking of sidewalks.

All cuts shall be backfilled either immediately upon completion of root pruning or upon completion of sidewalk repairs provided that adequate warning devices are placed and maintained at each location. Backfill material shall consist of dirt, CAB or crushed miscellaneous base.

The Contractor shall repair or replace sprinklers, plant material, and all utility service connections, which are damaged or removed as a result of the root-pruning operation. Repairs shall be initiated immediately and completed by the end of each working day. Repairs and replacements shall be at least equal to existing improvements, shall match them in finish and dimension, and will be done at Contractor's expense.

Where it is necessary to excavate adjacent to existing trees, the Contractor shall use all possible care to avoid injury to trees and tree roots. Excavation in areas where two-inch (2") and larger roots occur shall be done by hand. All roots two inches (2") and larger in diameter, except directly in the path of pipe or conduit, shall be tunneled under and shall be heavily wrapped with burlap, to prevent scarring or excessive drying. Where a ditching machine is run close to trees having roots smaller than two inches (2") in diameter the wall of the trench adjacent to the tree shall be hand trimmed, making clean cuts through. Trenches adjacent to trees should be closed within twenty-four (24) hours; and where this is not possible, the side of the trench adjacent to the tree shall be kept shaded with burlap or canvas.

301-1.4 Payment. [Add the following:]

Payment for root removal shall be included in the pertinent bid items in the bid proposal and shall include full compensation for furnishing all labor, materials, tools, equipment, and no additional compensation shall be allowed therefor.

302-5 ASPHALT CONCRETE PAVEMENT.

302-5.1 General. [Replace with the following:]

Asphalt Concrete shall conform to the requirements of Subsection 203-6, as modified by these Special Provisions and Orange County Public Works Standard Plan 1805.

302-5.4 Tack Coat. [Replace with the last paragraph:]

The contact surfaces of all cold pavement joints, curbs, gutters, manholes, and the like shall be painted with SS-1h emulsified asphalt paving asphalt immediately before the adjoining asphalt concrete is placed. The Contractor shall use "no track tack" or "trackless tack."

302-5.5 Distribution and Spreading. [Delete the sixth paragraph and add the following:]

The depositing, distributing, and spreading of the asphalt concrete shall be accomplished in a single, continuous operation by means of a self-propelled mechanical spreading and finishing strike-off assembly capable of being accurately regulated and adjusted to distribute a layer of the material to a definite predetermined thickness. The machine shall be equipped with automatic screed controls. The automatic screed controls require a reference system for the automatic system to follow. This reference can be the base on which the asphalt concrete is being placed, the

lane next to the material being placed, or a stringline. The automatic screed control can also follow a traveling reference system. A traveling reference system may be a ski attached to a control arm, which notes changes in base contours and adjusts the screed automatically to compensate. A stringline or traveling reference system shall be used to allow the automatic control to adjust screed height as necessary to maintain proper longitudinal (length-wise) grade of the pavement. To maintain proper transverse (width-wise) grade, the automatic screed control shall use a pendulum system attached to a beam running between the two screed pull arms. When paving is of a size or in a location that use of a self-propelled machine is impractical, the Engineer may waive the self-propelled requirement.

At those locations where new asphalt concrete pavement overlay joins existing asphalt pavement, the Contractor shall rake out all aggregate $\frac{3}{8}$ " or larger and feather the new paving to form a smooth transition to join the existing pavement.

302-6 PORTLAND CEMENT CONCRETE PAVEMENT

302-6.4 Finishing. [Add the following:]

1. **General.** Unless otherwise specified in this Subsection, broom, and steel trowel finish concrete used in the hardscape areas shall be constructed of concrete prepared as prescribed in Subsection 201-1. Portland Cement Concrete Pavement shall be constructed in accordance with Section 302-6 "Portland Cement Concrete Pavement" except as modified herein.
2. **Job Sample.** Contractor shall pour and finish a 4' x 4' square sample of each concrete finish and color using the contemplated materials and construction techniques. The sample shall include final finish color as specified, sawcut joints, and expansion joints and shall meet with the City's approval prior to placing any production concrete.
3. **Preparation.** The subgrade shall be compacted and prepared in accordance with the Plans and the Geotechnical Report.

302-9 ASPHALT RUBBER HOT MIX (ARHM).

302-9.1 General. [Add the following:]

All PCC surfaces to be crossed by truck used to haul ARHM that are within 500 feet of the work limits shall be covered with sand or other durable covering prior to apply tack coat.

Contractor shall have sufficient power brooms on site during all periods of distribution and spreading to provide for clean-up of haul routes and work areas. Power brooms shall provide miscellaneous clean-up of ARHM spoils as directed by the Engineer.

Power brooms used ahead of paving operations on accepted, clean, cold-planed areas shall only sweep areas that are accepted as clean after cold planing. Power brooms that have swept cold planed areas not accepted as shall not enter into accepted clean cold-planed areas. Power brooms used ahead of paving operations shall not be operated more than 60% full of sweepings.

It is imperative that citizens' complaints be resolved expeditiously. To achieve this, the Engineer's field representative will inform the Contractor of the complaint verbally and in writing. The Contractor, in turn, will contact the resident and inform the field representative within 24 hours of the action to be taken.

Bituminous Pavement Crack Sealing. Bituminous Pavement Crack Sealing consists of furnishing all labor, equipment, and materials and performing all operations in connection with bituminous pavement crack sealing for cracks $\frac{1}{4}$ " wide or wider.

All pavement cracks greater than or equal to $\frac{1}{4}$ " width shall be routed by mechanical means and cleaned by air blowing with an air compressor.

The crack sealing material shall be CRAFCO Polyflex Type III sealant or equal. The sealer shall be forced into the crack by use of a squeegee.

302-9.3 Distribution and Spreading. [Add the following:]

The ARHM asphalt shall be delivered and dumped directly into the paving machine. Depositing of material on the street will not be permitted.

In lieu of using no track tack, to avoid picking up loose rock in the overlay area, the tires of all trucks must be lightly oiled with soybean oil or equivalent, but not to the point of runoff.

Contractor shall designate staging areas for trucks to switch trailers and perform any clean out necessary. Trucks shall use only designated areas for these purposes.

In order to prevent cold longitudinal joints, if a street is not completed in the same day, only transverse joints (to be located at crosswalk stripes) will be left open for the next workday. Longitudinal joints shall coincide with lane lines.

Contractor shall maintain a functioning infrared heat measurement device in close proximity to each paving machine at all times. Contractor shall provide a pavement temperature reading with an infrared heat measurement instrument when requested by the Engineer.

302-9.4 Rolling. [Add the following:]

To insure optimum quality control, the use of more than one paver must be approved in advance by the Engineer, and will generally require one foreman, one power sweeper, and a full complement of rollers for each paving machine. An extra breakdown roller shall be on site at all times, free of defects.

Vibratory rollers shall be rated at 21,000-point dynamic force. All vibratory rollers shall have an adjustable range of vibration set at low vibration.

Intermediate rolling shall be provided such that a total of six (6) passes are performed before pavement temperature drops below 200°F. An additional intermediate roller shall be provided to achieve this result.

A finish roller shall be provided in addition to intermediate rolling.

SECTION 303 CONCRETE AND MASONRY CONSTRUCTION

303-1.8 Placing Concrete

303-1.8.1 General [Add the following paragraph:]

The Contractor shall exercise caution in placement of concrete in congested areas to ensure proper consolidation and that there are no voids. Adequate provisions shall be made for visual inspection of concrete placement. Use of smaller maximum aggregate sizes, or other methods as necessary may be proposed by the Contractor and will be permitted only after evaluation by the City Representative.

303-1.9.2 Ordinary Surface Finish. [Add the following paragraph:]

Ordinary Surface Finish shall not apply to rock pockets which, in the opinion of the Engineer, are of such extent or character as to affect the strength of the structure materially or to endanger the life of the steel reinforcement. In such cases, the Engineer may declare the concrete defective and require the removal and replacement of the structure affected.

303-1.10 Curing. [Amend first paragraph with the following:]

Exposed concrete surfaces shall be sprayed with Type 2 curing compound at a uniform rate of one gallon per 150 square feet.

303-1.12 Payment [Replace paragraph one with the following:]

Portland Cement Concrete structures shall be included in the lump sum contract price and shall include full compensation for furnishing all labor, materials, tools and equipment and doing all work required to construct the structure in conformity with the plans and specifications.

Should the Contractor request and obtain permission to use admixtures for his own benefit, he shall furnish such admixtures and incorporate them in the concrete mixture at his expense, and no additional compensation will be allowed therefor.

Should the City Representative direct the Contractor to incorporate any admixtures in the concrete when their use is not required by these specifications, furnishing the admixtures and adding them to the concrete will be paid for as Extra Work as provided in Subsection 3-3, as amended by these Special Provisions.

303-5 CONCRETE CURBS, WALKS, GUTTERS, CROSS-GUTTERS, ALLEY, INTERSECTIONS, ACCESS RAMPS, AND DRIVEWAYS

303-5.1.1 General. [Add the following paragraph:]

Construction of Portland Cement Concrete curbs and gutter, sidewalk, and pedestrian ramps shall be constructed in accordance with the Plans and the Standard Specifications as modified herein.

Contractor shall pour and finish a 4'x4' square sample of concrete finish and color using the contemplated materials and construction techniques. The sample shall include final finish color, and texture. Construction and expansion joints sample per Plan shall meet with the City's approval prior to placing any concrete.

Curing compound shall be Type II conforming to the provisions in Section 201-4 "Concrete Curing Compound" of the Standard Specifications. Contractor shall exercise caution in using such curing compounds so as to avoid spraying any cars that may be parked adjacent to the work site.

Shapes and sizes of concrete curbs and gutters shall be as indicated on the drawings, and the concrete shall conform to all applicable conditions of these documents. Concrete shall be placed in such a manner as to prevent distortion of the forms and shall be vibrated as required to insure an acceptable product.

As soon as the concrete will allow, strip the forms and trowel smooth the curb face and top. Tool the edges of expansion joints with an approved $\frac{3}{8}$ " edging tool.

After curing, AC deeplift shall be placed. The completed curb and gutter shall be protected from damage until accepted.

The Contractor shall repair and clean, at his own expense, all concrete damaged or discolored during construction. Where any curb requires repair before acceptance, repair shall be made by removing and replacing the entire curb between joints and not by refinishing the damaged portions.

The cost of removing existing sidewalk, driveway aprons, ramps, and curb and gutter, including sawcutting, and the Truncated Domes required for installation on each ramp are included in the bid price per SF, shall be included in the unit prices of the associated items of work, and no additional compensation shall be allowed.

Contractor shall match existing curb face height and gutter width.

303-5.2 Forms

303-5.2.1 Standard Forms. [Add the following:]

1. Use flexible metal, 1" lumber, or plywood forms to form radius bends.
2. Install, align, and level forms; stake and brace forms in place. Maintain following grade and alignment tolerances.
 - a. Top of Form: Maximum $\frac{3}{8}$ " in 10'-0".
 - b. Vertical Face: Maximum $\frac{1}{4}$ " in 10'-0".
3. The Contractor shall include all fine grading and compaction with regard to setting forms during concrete placement.

303-5.4.1 General. [Add to the first paragraph:]

1. Provide expansion joints using premolded joint filler at concrete work abutting curbs, walks, and other fixed objects.
 - a. Locate expansion joints as indicated. When not indicated, provide joints at maximum 10'-0" on center for curbs and walks. Align expansion joints in abutting curbs and walks.

- b. Install joint fillers full width and depth of joint. Recess top edge below finish where joint sealants are indicated.
- c. Install joint filler full width and depth of joint. Provide top edge flush with adjacent finished surface.
- d. Provide joint fillers in single lengths for the full slab width whenever possible. Fasten joint filler sections together when multiple lengths are required.
- e. Where intersecting joints occur, join top edge and continue any spliced joints without deviation of form line or direction.
- f. Protect the top edge of the joint filler during concrete placement.

303-5.9 Measurement and Payment.

Payment for Remove and Replace Concrete Curb and Gutter shall be paid for at the contract unit price bid per **LINEAR FOOT**. Payment for Remove and Replace PCC Sidewalk and Remove Existing and Construct New PCC Curb Ramp shall be paid for at the contract unit prices bid per **SQUARE FOOT**. The price bid shall be considered to include full payment for all materials, labor, equipment, and incidentals required to construct the concrete improvements (including sawcutting, removals, AC slot patching, and truncated domes) in accordance with the Contract Documents.

SECTION 310 PAINTING

310-1 GENERAL. [Add the following to this section:]

Quality Control and Requirements

1. Permits and Fees

The Contractor shall obtain and pay for any and all permits and inspections as required.

2. Manufacturer's Directions

Manufacturer's directions and detail drawings shall be followed in all cases where the manufacturer of articles used in this contract furnish directions covering points not shown in the drawings and specifications.

3. Ordinances and Regulations

All local, municipal, and State laws and rules and regulations governing or relating to any portion of this work are hereby incorporated into and made a part of these Specifications and their provisions shall be carried out by the Contractor. Anything contained in these Specifications shall not be construed to conflict with any of the above rules and regulations or requirements of the same. However, when these Specifications and drawings call for or describe materials, workmanship, or construction of better quality, higher standard, or larger size than is required by the above rules and regulations, the provisions of these Specifications and drawings shall take precedence.

SECTION 314 TRAFFIC STRIPING, CURB AND PAVEMENT, MARKINGS AND PAVEMENT MARKERS

314-1 General. [Add the following:]

Traffic stripes, legends, and raised pavement markers shall conform to the 2014 California Manual of Uniform Traffic Control Devices (MUTCD) and all appurtenant specifications.

Traffic striping shall conform to Sections 214 and 314 as modified by these Special Provisions. Traffic control shall be as per WATCH Manual, 2019 edition.

Pavement legends shall conform to Agency stencils (same as used by the County of Orange).

Stripes and pavement legends shall be reflectorized.

314-4 APPLICATION OF TRAFFIC STRIPING AND CURB AND PAVEMEB MARKINGS.

314-4.2 Control of Alignment and Layout.

314-4.2.1 General. [Replace the first paragraph with the following:]

The Contractor shall furnish the necessary control points for all striping and markings and shall be responsible for the completeness and accuracy thereof to the satisfaction of the Engineer.

In no case shall any section of street be left without the proper striping for more than 24 hours or over weekends or holidays.

314-4.3.5 Application. [Add the following:]

The dry paint film thickness shall be 8 to 10 mils. Glass beads shall be applied at the rate of 165 pounds per mile of solid 6-inch-wide stripe (one pound per 16 square foot).

Traffic stripes and pavement markings on new surfacing shall be applied in two coats, except where otherwise shown on the plans. Temporary tabs shall be removed between the first and second coats of paint. The first coat of paint shall be applied at least seven (7) days prior to the application of the second coat. On existing surfacing, traffic stripes and pavement markings may be applied in one coat.

A 3-inch-wide black stripe shall be painted between the two 6-inch-wide yellow stripes of a double traffic stripe.

Each coat of paint for any traffic stripe, including glass beads where required, shall be applied in one pass of the striping machine, regardless of the number, widths, and patterns of individual stripes involved.

Paint to be applied in one coat shall be applied at an approximate rate of one gallon per 107 square feet.

Drips, overspray, improper markings, and paint material tracked by traffic shall be immediately removed from the pavement surface by methods approved by the Engineer.

Newly placed traffic stripes and pavement markings shall be protected from damage by public traffic or other causes until the paint is thoroughly dry.

Paint and glass beads for traffic stripes and pavement markings will be furnished by the Contractor, including paint for cattracks and dribble lines.

Unless otherwise directed by the Engineer, glass beads shall be uniformly incorporated in all coats of paint concurrently with the application of the paint, except that glass beads shall not be applied to black paint. Beads shall be embedded in the coat of traffic paint being applied to a depth of one-half their diameters.

Any removal of traffic stripes and markings shall be accomplished by the wet sandblasting method or waterblasting method. The machine used for this purpose shall meet all requirements of the air pollution control district having jurisdiction in the project area. All sand used in wet sandblasting shall be removed without delay as the operation progresses.

314-4 APPLICATION OF TRAFFIC STRIPING AND CURB AND PAVEMENT MARKINGS.

314-4.3.7 Payment. [Replace with the following:]

Payment for all traffic striping and pavement markings shall be included in the Striping and Pavement Markings per **LUMP SUM** of the bid item.

Payment shall include full compensation for furnishing all labor, material (including adhesives, glass beads markers and paint), tools, equipment and incidentals; and for doing the work involved in traffic striping, pavement markings, and markers complete in place, including necessary traffic control as specified in these Special Provisions and as directed by the Engineer, and no additional compensation will be allowed.

Payment for the removal of existing traffic striping and pavement markings shall be made at the contract **LUMP SUM** price, which shall include full compensation for furnishing all labor, materials, tools, equipment and incidentals required to remove existing traffic striping and pavement markings (multiple layers, if necessary) where specified, including traffic control and clean-up, and no additional compensation will be allowed.

The Contractor shall include in its lump sum bid price, the re-painting (one coat only) of existing traffic striping and pavement markings outside the limits of work, which are tarnished by the Contractor's operations.

PART 4—EXISTING IMPROVEMENTS

SECTION 400 PROTECTION AND RESTORATION

400-2 PERMANENT SURVEY MARKERS [Replace section in its entirety with the following:]

The Contractor will be required to contract for the services of a Land Surveyor or Civil Engineer authorized to perform surveying services licensed in the State of California to perform the following services:

Establish the location of all monuments that are presently visible that will be disturbed as a result of the street resurfacing and reestablish said monuments at the completion of the project. The Surveyor will be required to tie out all existing monuments (only visible monuments will be required to be reset) that will be disturbed in conformance with all applicable state laws prior to the resurfacing operations.

The Surveyor shall prepare and furnish to the City Engineer, prior to any surfacing, a plan or sketch showing the locations of the monuments found and proposed to be preserved. The project may be subdivided into areas that may be submitted individually to allow the Surveyor to stay in front of the Contractor's operations and not impede the Contractor's progress. Upon completion of the resurfacing, the Surveyor shall reestablish all disturbed monuments in conformance with all applicable state laws.

The Licensed Land Surveyor shall file corner record(s) as required by Sections 8772 and 8773, et seq., of the California Business and Professions Code. Corner Records shall be prepared on the form required and in compliance with BPELSG Rule 464 for each monument being preserved. More than one preserved monument may be shown on a Corner Record, if desired by the responsible surveyor. In lieu of the Corner Records, a Record of Survey may be prepared showing all monuments and tie/reference points involved in this project.

All records, either Corner Records or Record of Survey, will be forwarded for checking and recordation to the County of Orange. At the same time these are forwarded to the County, a digital copy of same in Adobe PDF format shall be delivered to the City Engineer. No records will be finally filed/recorded at the County until approved as to form and content by the City Engineer.

For each monument reset, a Corner Record, or Record of Survey, in compliance with state laws and Board Rules shall be prepared and forwarded to the County of Orange for review and filing. At the same time, and every time, the records are submitted to the County, they shall also be transmitted to the City Engineer in digital format for his review and approval. The final filing or recordation shall not be made until the City Engineer indicates his approval. Final payment of the Contract Retention for the project will not be made until all monuments have been reset to the satisfaction of the City, all records have been processed through the County of Orange, and approved and filed in the case of Corner Records, or approved and recorded in the case of a Record of Survey. The City reserves the right to have the monuments and documentation inspected by the City Surveyor for compliance with all State Law, The Subdivision Map Act, and the Professional Land Surveyor's Act. Digital copies in PDF format of all the filed/recorded documents shall be furnished to the City Engineer.

Payment for Reset Visible Survey Monuments to Grade shall be included in the various items of work and includes compensation for all items described in these specifications and any items necessary to comply with all State Law and requirements of the Orange County Surveyor, and no additional compensation will be provided therefor.

400-3 PAYMENT [Delete last sentence and replace with the following:]

Permanent survey markers will be restored by the Contractor at its own expense.

SECTION 402 UTILITIES

402-1 LOCATION

402-1.1 General. [Add the following paragraph:]

The Contractor shall notify the utility agency as listed in the General Specifications at least 48 hours in advance of excavating around any of their structures. The Agency does not guarantee that all utilities are listed.

Existing Utilities:

1. Information on the drawings relating to existing utility lines and services is from the best sources presently available. All such information is furnished only for information and is not guaranteed. The Contractor shall excavate test pits as required to determine exact locations of existing utilities. Call utility locating service for precise utility locations before beginning any work. Underground Service Alert 800-422-4133.
2. Perform Work and provide necessary materials to disconnect or relocate existing utilities as indicated. Record on record drawings all existing utility termination points before disconnecting. The costs for such Work shall be absorbed by the Contractor in the unit prices bid for the various contract items.
2. When uncharted or incorrectly charted underground piping or other utilities and services are encountered during site work operations, notify the applicable utility company immediately to obtain procedure directions. Cooperate with the applicable utility company in maintaining active services in operation.

402-1.2 Payment. [Replace with the following.]

Payment for utility location by the Contractor shall be included in the various bid items of work.

SECTION 403 MANHOLE ADJUSTMENT AND RECONSTRUCTION

403-1 GENERAL. [Replace entire text with the following:]

Utility manhole and vault frames and covers within an area to be paved or graded will be set by the owners thereof to finished grade.

Sewer and storm drain manhole frames and covers within the area to be paved or graded shall be set to finish grade by the Contractor. Water valve frames and covers within the area to be paved or graded shall be set to finish grade by the Contractor.

The Contractor shall remove all debris from the interior of manholes and shall clean all foreign material from the top of the frames and covers.

Prior to the start of work all valve and manhole lids shall be masked off and covered with plastic by the Contractor.

If the manhole cover is unstable or noisy under traffic, said conditions shall be corrected by placing a coil of asphalt-saturated rope, a plastic-type washer, or asphaltic compounds, as approved by the Engineer, on the cover seat.

The Contractor will exercise care so that surface materials such as rocks, dirt, and debris do not enter sewer lines. The Contractor shall inform SMWD forty-eight (48) hours prior to beginning work.

Adjustment of Water Valve Covers. Existing valve covers shall be adjusted to grade by the Contractor. Contractor shall provide slip cans. Water valves shall be protected in place and shall be accessible at all times during construction. The Contractor shall notify ETWD, SMWD and MNWD forty-eight (48) hours prior to the beginning of work.

Adjustment of Survey Monument Covers. Existing survey monument covers shall be adjusted to grade by the Contractor.

At all times the official survey monuments shall be protected from displacement and damage. If an existing monument is disturbed, displaced, or damaged, the Contractor shall reimburse the City for all costs associated with contracting with a Licensed Professional Land Surveyor to reset said monuments, and file all necessary documents with the Orange County Surveyor's Office.

Survey monument boxes shall be marked as to their location by the Contractor prior to the placement of the pavement. The Contractor shall furnish new cans if existing cans are damaged during operation. Cans shall be raised to the proper grade within five working days with an asphalt concrete structural section equivalent to that adjacent thereto. Any required final asphalt pavement on the adjusted cans shall be placed within 24 hours after the box has been adjusted to grade.

A false bottom system shall be in place in all adjusted manholes. Any manholes needing adjustment shall have all existing mortar as well as the entire concrete frame/ring removed, new ring or rings (however many may be necessary) set, and ½ inch of new cement mortar and a new concrete frame placed. Proper adjustment shall be completed to ensure the manholes are flush with finished grade at the completion of the project. For manholes owned by Santa

Margarita Water District (SMWD), all work on manholes shall be performed in accordance with SMWD Standard Plan S1.

Adjustments to grade of manholes shall conform to the requirements of the Santa Margarita Water District (SMWD) and these Special Provisions:

The method of adjusting existing manholes in areas of new construction or reconstruction shall be as follows:

1. Upon completion of the asphalt overlay, circular holes shall be cut where the manholes exist.
2. The manhole frames and covers shall then be raised to the proper grade, and the pavement shall be replaced with an equivalent asphalt concrete structural section.

Upon the completion of work to the satisfaction of the Water District Inspector, the false bottom placed in the manholes and all debris and foreign material collected in the manholes shall be completely removed by the permittee.

All water valves needing adjustment shall have the existing riser and cover as well as the entire concrete ring removed. A new riser and cover shall be set and a new concrete ring placed. For valves owned by Santa Margarita Water District (SMWD), all work on valves shall be performed in accordance with SMWD Standard Plan W9.

Any Water District facilities damaged by the Contractor's work shall be repaired to the satisfaction of the Water District Inspector. Unless agreed upon prior to the start of construction with the Water District Inspector, it shall be the responsibility of the Contractor to clean and repair all facilities to the satisfaction of the Water District Inspector regardless of whether or not the damage was pre-existing or caused by the work of the contractor under this contract.

In the event of any conflicts between the text in the Special Provisions and the text in the Greenbook, this text shall prevail.

403-5 PAYMENT. [Replace entire text with the following:]

Adjust Manhole Cover to Grade, including all appurtenant work, including any callouts to Double Adjustments to Grade shall be made at no extra cost, which shall be paid at the contract unit price bid per **EACH** of the associated line item.

Adjust Water Valve Cover to Grade, including all appurtenant work, including any callouts to Double Adjustments to Grade shall be made at no extra cost, which shall be paid at the contract unit price bid per **EACH** of the associated line item.

Adjust Survey Monument Cover to Grade, including all appurtenant work, shall be paid at the contract unit price per **EACH**.

Any utility adjustment to grade called out on the plan, shall be paid at no additional cost if it is found during construction that a double adjustment is to be required.

SECTION 404 COLD MILLING

404-1 General. [Add the following:]

The area to be cold-planed shall not proceed in advance of the ability of the pavement operator to cover it within five (5) working days.

404-2 Milling Machines. [Replace with the following:]

The Contractor shall furnish a self-propelled machine especially designed and built for grinding flexible and rigid pavements to the depth shown on the Plans in one pass. The machine shall be equipped with standard automatic depth controls and must maintain a constant cutting depth and width without tearing or gouging the underlying surface and blade material into a windrow. The machine shall consist of 60" minimum width cutting drum with carbide-tip teeth. Drum lacing patterns shall permit a grooved or smooth surface finish as selected by the Engineer, and the drum shall be totally enclosed in a shroud to prevent discharge of any loosened material into adjacent work areas. The machine shall be capable of operating at speeds from 5 to 50 feet per minute and designed so that the operator can observe the work without leaving his control area. It shall be adjustable as to crown and depth by tilting the drum axis and shall

have a guidance system furnished to assist operator to control grade and match adjacent pavements or cuts. The equipment shall have been operated on similar work completed prior to the award of this contract.

404-12 Payment. [Replace with the following:]

Payment for Bituminous Pavement milling, complete in place, including dust control, removal of loose materials, and the provision of temporary AC transitions at milling limits to the satisfaction of the City's Inspector, shall be made at the contract unit price bid per square foot, and no additional compensation is allowed therefor.

PART 6—TEMPORARY TRAFFIC CONTROL

SECTION 600 ACCESS

600-1 GENERAL [Add the following:]

The Contractor shall notify in writing all affected property owners of the proposed construction schedule a minimum of 48 hours, but not more than 72 hours, in advance of any limitation or closure of access to their property. Form of said notice shall be as approved by the Engineer and shall contain the date and time of the closure. In the event of delay, whether beyond the control of the Contractor or not, the Contractor shall notify all affected property owners as to the extent of the delay and his revised schedule. In the event of delay over 72 hours, the Contractor shall re-notify the property owners as described above. Payment for notification and coordination as per Section 7-3 as modified herein shall be included in the compensation paid for the various items of work and no additional compensation will be allowed. The "Notices" will be furnished by the Contractor.

600-2 VEHICULAR ACCESS [Add the following paragraph:]

When entering or leaving roadways carrying public traffic, the Contractor's equipment, whether empty or loaded, shall in all cases yield to public traffic.

At least partial driveway access shall be maintained at all times, unless otherwise approved by the City. Complete driveway access shall be restored outside of working hours.

Two lanes of traffic will be maintained on Melinda Road at all times in each direction, except as noted herein. For work outside the established work areas, lane closures shall be limited to the hours noted in section 6-7.2.

600-3 PEDESTRIAN ACCESS [Add the following paragraph]

Pedestrian access shall be maintained during access ramp re-construction, if any.

SECTION 601 TEMPORARY TRAFFIC CONTROL FOR CONSTRUCTION AND MAINTENANCE WORK ZONES

601-3.7.5 Portable Changeable Message Signs (PCMS) [Add the following:]

The Contractor shall provide dynamic message signs with a panel width size of no more than 80 inches.

The Contractor shall reprogram dynamic message signs within four (4) Working Day hours of the Engineer's e-mailed request. Working Day hours shall mean those hours within the work day specified in Section 1.2. Failure to reprogram the message signs within the above timeframe shall result in the deduction of that day's changeable message board payment to the Contractor, and deductions shall continue to occur for each whole or partial day the message board is not reprogrammed until such time the message board is reprogrammed.

PART 7 - STREET LIGHTING AND TRAFFIC SIGNALS

700-5.8 Detectors.

700-5.8.2.3 Conductors [Add the following:]

Loops shall be installed on the same day in which the loop slots are cut. This shall include placement of the loop conductors and sealant.

Loop wire shall be Type 2.

Loop detector lead-in cable shall be Type B.

The Contractor shall test the detectors with a motor-driven cycle, as defined in the California Vehicle Code, which is licensed for street use by the Department of Motor Vehicles of the State of California. The unloaded weight of the vehicle shall not exceed 220 pounds, and the engine displacement shall not exceed 100 cubic centimeters. Special features, components, or vehicles designed to activate the detector shall not be permitted. The Contractor shall provide an operator who shall drive the motor-driven cycle through the response or detection area of the detector at not less than three miles per hour or more than seven miles per hour. The detector shall provide an indication in response to this test.

Each loop shall be capable of accepting two or more sensor units.

In testing a vacant loop, any drift that exceeds an average of more than 1 (one) hertz/minute shall be cause for rejection.

Sealant shall be hot-melt rubberized asphaltic emulsion, for use in sealing inductive wire loops and leads imbedded in asphalt, per the Caltrans Standard Specifications.

The contract unit price bid per **EACH** shall constitute full compensation for all labor, sawcutting, material, tools, and incidentals, to provide the item in place as indicated on plans and as directed by Engineer, and no further compensation shall be allowed therefor.

APPENDIX A

APPLICABLE STANDARD PLANS

(Not Comprehensive — For Contractor's Convenience Only)

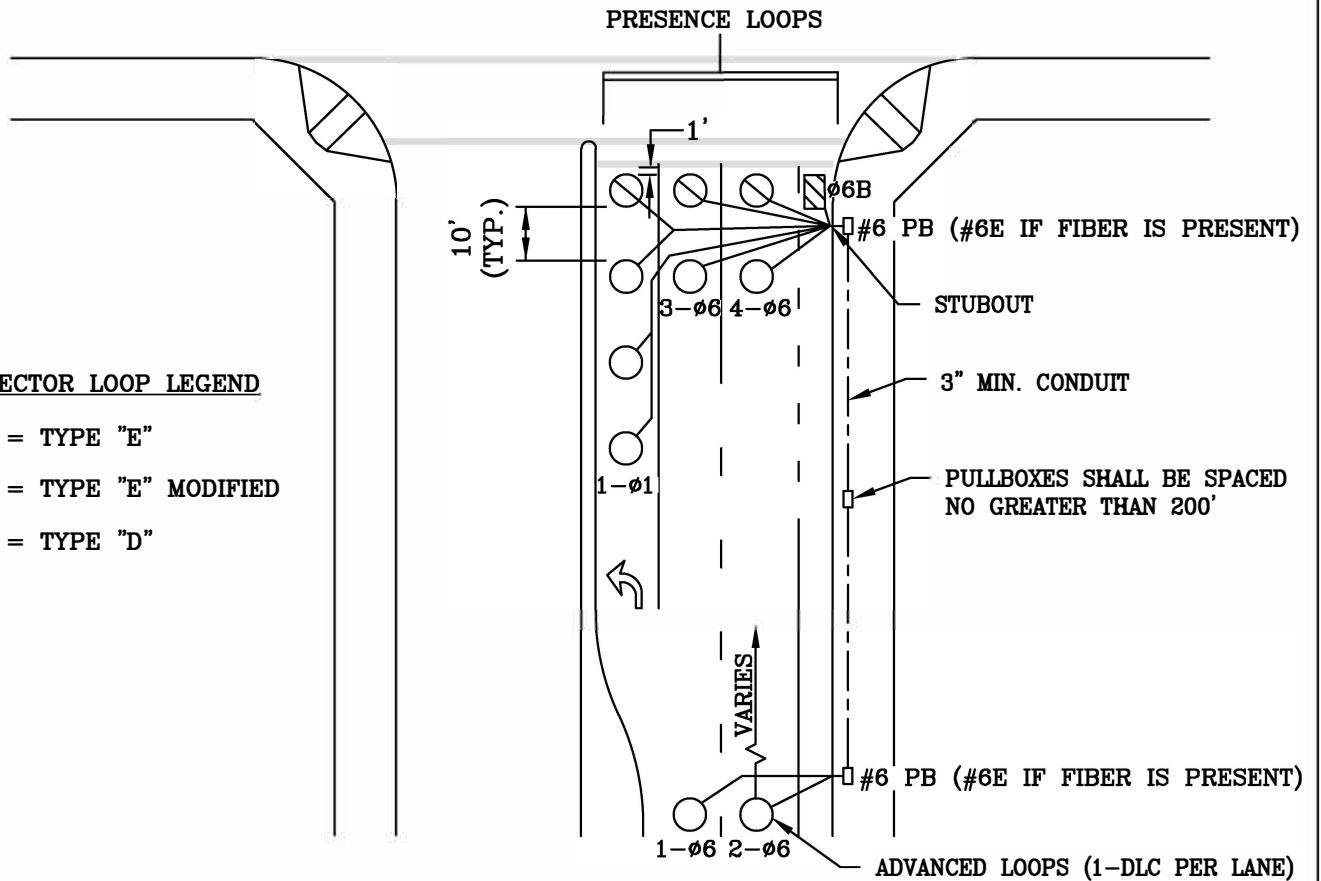

DETECTOR LOOP LEGEND

- = TYPE "E"
- ⊗ = TYPE "E" MODIFIED
- ⊠ = TYPE "D"

NOTES:

1. UNLESS SHOWN OTHERWISE ON PLANS, INDUCTIVE LOOP DETECTORS SHALL BE 6 FOOT IN DIAMETER WITH 10' SPACING IN THE DIRECTION OF TRAVEL AND SHALL BE CENTERED WITHIN THE LANE.
2. LOOPS DETECTOR CONDUCTORS SHALL BE TYPE 2 PER THE LATEST CALTRANS SPECIFICATIONS, SECTION 87.
3. ALL STOP LINE/PRESENCE LOOP DETECTION SHALL BE TYPE "E" OR TYPE "D" LOOP DETECTION (BICYCLE DETECTORS), MODIFIED TO TYPE SHOWN PER PLANS.
4. LOOPS SHALL BE SPliced IN SERIES AND BY LANE.
5. PRESENCE LOOPS SHALL BE LOCATED ONE (1) FOOT BEHIND THE LIMIT LINE.
6. ADVANCED LOOPS SHALL BE INSTALLED PER THE LATEST CAMUTCD SET BACK REQUIREMENTS.
7. LOOPS INSTALLED FOR RIGHT-TURN LANES SHALL BE INSTALLED AS SHOWN ON THE PLANS OR AS DIRECTED BY THE CITY ENGINEER.
8. SAWCUTS SHALL BE FILLED WITH SEALANT PER LATEST CALTRANS STANDARD SPECIFICATIONS, SECTION 87.

CITY OF MISSION VIEJO

**TRAFFIC LOOP
INSTALLATION LAYOUT DETAIL**

STANDARD
DETAIL NO.

348



Rich Schlinger

03/21/23

APPROVED BY: CITY ENGINEER RCE 51160

DATE

SHT 1 OF 1

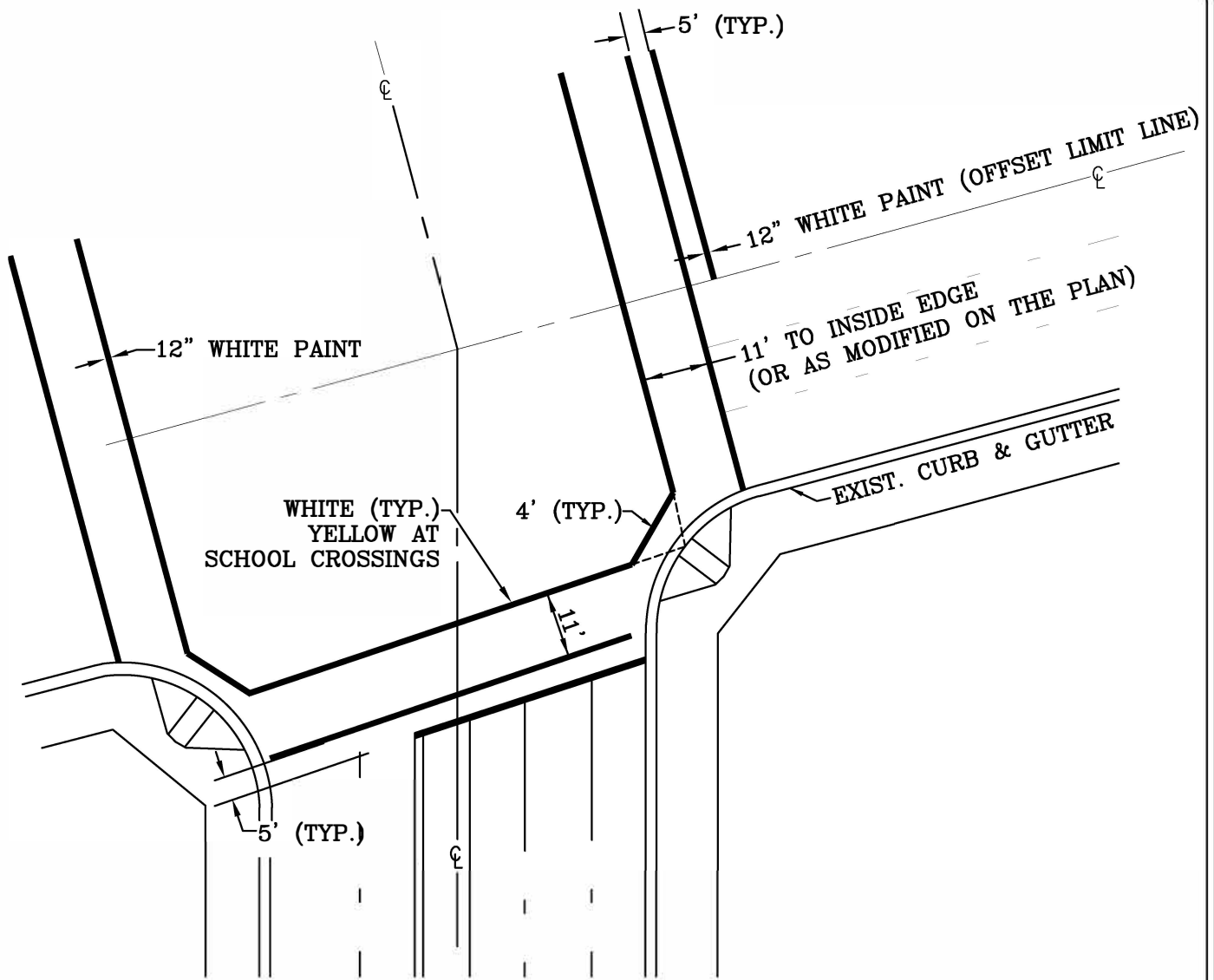

NOTES:

1. ALL CROSSWALK MARKINGS & LIMIT LINES SHALL BE PAINTED WITH TWO (2) COATS (NO THERMOPLASTIC). THE SECOND COAT SHALL BE APPLIED A MINIMUM OF 1 WEEK AFTER THE FIRST COAT. PAINT SHALL BE PER THE LATEST CALTRANS SPECIFICATIONS, SECTION 84 "MARKINGS".
2. LIMIT LINES SHALL BE 12" WIDE LOCATED 5' BEHIND THE CROSSWALK.
3. INSTALL YELLOW MARKINGS AT SCHOOL CROSSINGS WHERE SHOWN ON PLANS. OFFSET LIMIT LINES SHALL ALWAYS BE PAINTED WHITE.

CITY OF MISSION VIEJO



PAINTED STANDARD
CROSSWALK DETAIL

STANDARD
DETAIL NO.

346

Rich Schlinger

03/21/23

APPROVED BY: CITY ENGINEER RCE 51160

DATE

SHT 1 OF 1

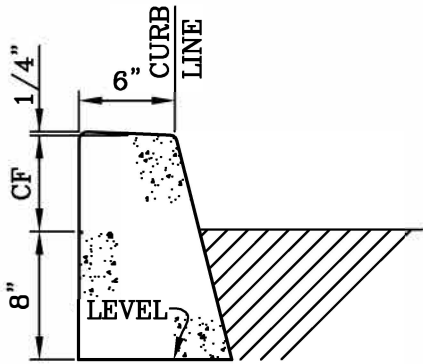

TYPE B-6 AND B-8

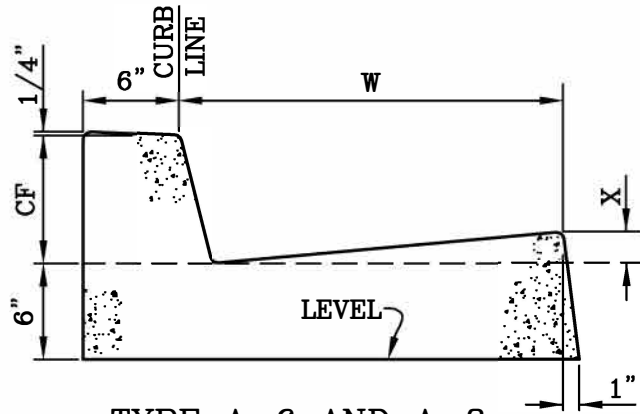

TYPE A-6 AND A-8
 W=18" X=1 1/2" FOR 6" CF
 W=24" X=2" FOR 8" CF

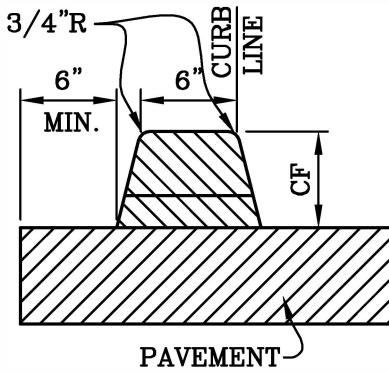

TYPE E-6 AND E-8

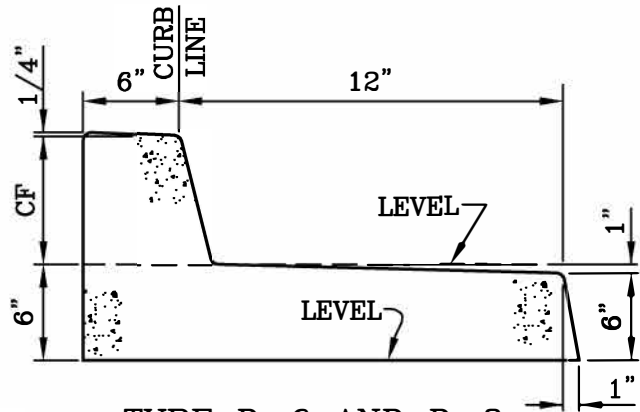

TYPE D-6 AND D-8

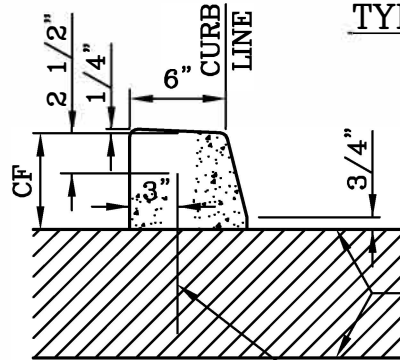

TYPE C-6 AND C-8

SEE SHT. 2 FOR NOTES

#4 DOWEL AT 4' OC
 10" MIN. LENGTH,
 GROUTED IN PLACE.

CITY OF MISSION VIEJO



CURBS AND GUTTERS

STANDARD
 PLAN NO.

316

Robert Anderson

9-23-03

APPROVED

RCE 30190

DATE

SHT 1 OF 2

NOTES:

1. ALL DIMENSIONS ARE MEASURED IN INCHES.
2. CURB FACE BATTER TO BE 3:12 FOR ALL CURBS.
3. ALL CURBS AND GUTTERS ARE CONSTRUCTED OF PORTLAND CEMENT CONCRETE TYPE V. EXCEPT TYPE E WHICH IS ASPHALT CONCRETE.
4. TYPE C CURB SHALL BE ANCHORED WITH DOWELS AS SHOWN OR WITH AN EPOXY APPROVED BY THE CITY ENGINEER.
5. GRADE SHALL BE MEASURED AT CURB LINE AT TOP OF CURB.
6. ALL EXPOSED CORNERS ON P.C.C. CURBS AND GUTTERS TO BE ROUNDED WITH A 1/2" RADIUS.
7. "CF" IS CURB HEIGHT. IT IS THE LAST NUMBER IN THE DESIGNATION.
8. WEAKENED PLANE JOINTS REQUIRED AT 10' INTERVALS.

CITY OF MISSION VIEJO



CURBS AND GUTTERS
NOTES

STANDARD
PLAN NO.

316

Robert Anderson 9-23-03
APPROVED RCE 30190 DATE

SHT 2 OF 2

CURB RETURN RADIUS	APPLICATION
25'	RESIDENTIAL STREET INTERSECTING ANOTHER RESIDENTIAL STREET
35'	ARTERIAL HIGHWAY INTERSECTING A RESIDENTIAL STREET OR ARTERIAL HIGHWAY INTERSECTING ANOTHER ARTERIAL HIGHWAY

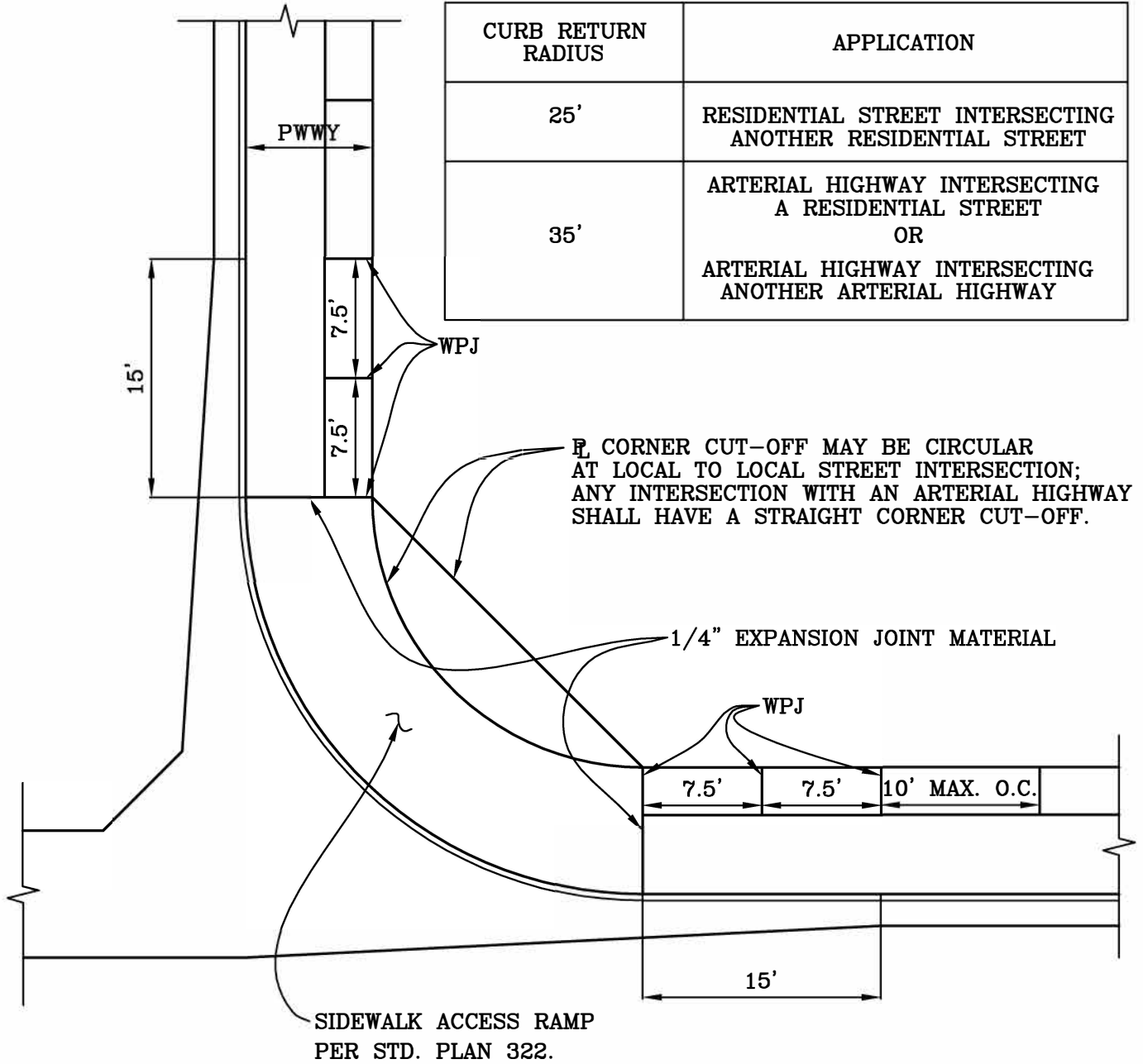

R CORNER CUT-OFF MAY BE CIRCULAR AT LOCAL TO LOCAL STREET INTERSECTION; ANY INTERSECTION WITH AN ARTERIAL HIGHWAY SHALL HAVE A STRAIGHT CORNER CUT-OFF.

NOTE:
ELEVATION DIFFERENCE BETWEEN B.C.R. AND E.C.R. SHALL NOT EXCEED 4'.

CITY OF MISSION VIEJO



SIDEWALK RETURNS AND CURB RADIUS

STANDARD PLAN NO.

321

Robert Anderson 9-23-03
APPROVED RCE 30190 DATE

SHT 1 OF 3

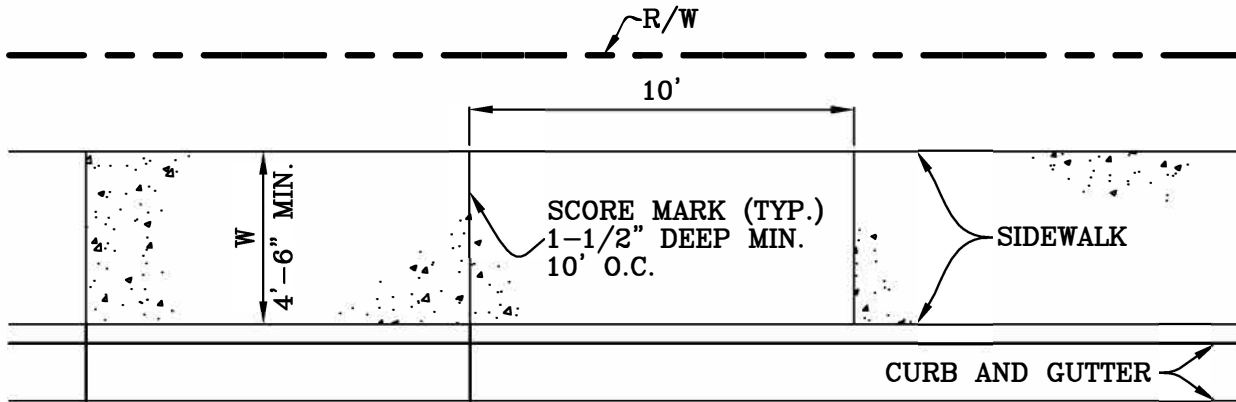

DETAIL 1

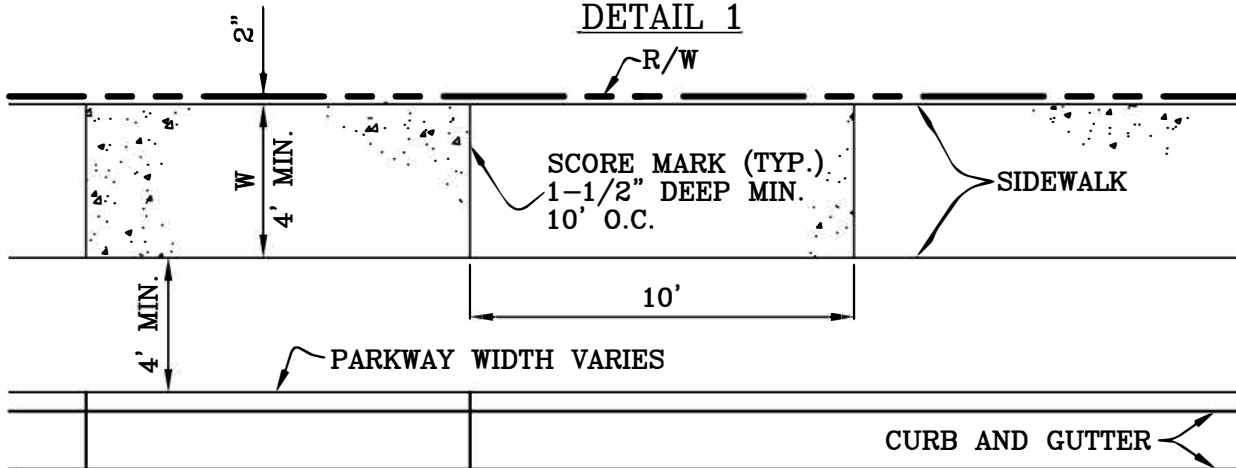

DETAIL 2

NOTES:

1. THICKNESS OF SIDEWALK SHALL BE 4" EXCEPT IN DRIVEWAY APRONS. (STD. 306).
2. CURB AND GUTTER SHALL HAVE 1/4" PREMOLDED EXPANSION JOINTS AT THE ENDS OF CURB RETURNS AND 1-1/2" DEEP WEAKENED PLANE JOINTS AT INTERVALS SHOWN HEREON. JOINTS SHALL HAVE EDGES WITH 1/8" RADII.
3. SEE SHEET 1 OF 3 FOR ADDITIONAL EXPANSION JOINT REQUIREMENTS.
4. SIDEWALK SHALL BE PORTLAND CEMENT CONCRETE TYPE V.
5. ALL SOILS SHALL BE BROUGHT TO MAXIMUM SATURATION AS REQUIRED IN THE APPROVED SOILS REPORT. THE SOILS ENGINEER SHALL PROVIDE CERTIFICATION ON THE FORM PROVIDED BY THE CITY STATING THE MOISTURE CONTENT HAS BEEN MAINTAINED AS REQUIRED PRIOR TO AND DURING THE PLACEMENT OF CONCRETE. IN HILLSIDE AREAS, SOIL SHALL BE SATURATED AS RECOMMENDED BY THE SOILS ENGINEER AND APPROVED BY THE CITY ENGINEER.
6. SIDEWALKS ARE REQUIRED ON THE SIDE OF STREETS WHERE PARKING IS ALLOWED (I.E. PARKING ONE SIDE, SIDEWALK ON THAT SIDE. PARKING BOTH SIDES, SIDEWALK ON BOTH SIDES.) WHERE NO PARKING IS ALLOWED, PEDESTRIAN CIRCULATION MUST BE PROVIDED EITHER WITH A SIDEWALK OR A GREENBELT PATHWAY.
7. PRE-EMERGENT WEED KILLERS MUST BE APPROVED PRIOR TO CONSTRUCTION OF SIDEWALK.

CITY OF MISSION VIEJO



SIDEWALK DETAILS

STANDARD
PLAN NO.

321

Robert Anderson 9-23-03

APPROVED RCE 30190 DATE

SHT 2 OF 3

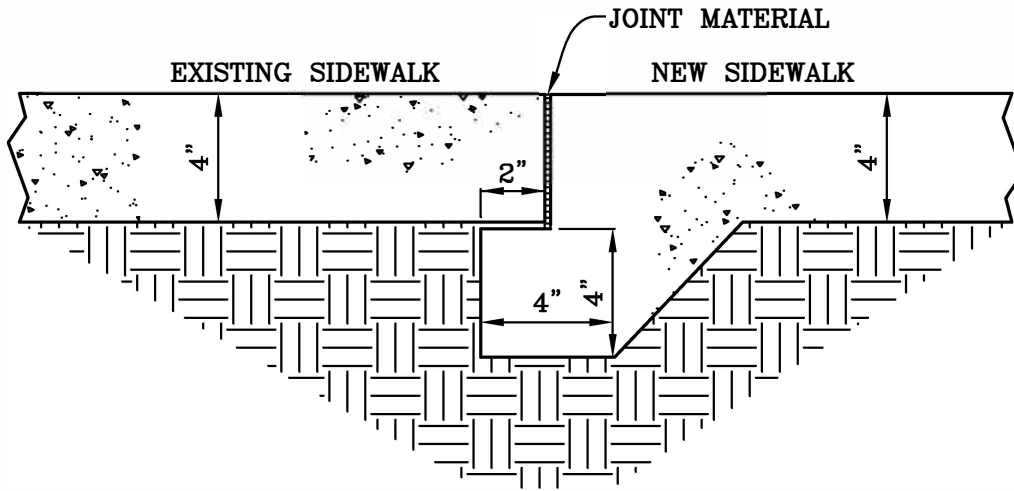

NOTES:

1. ALL APPLICABLE NOTES FROM SHEET 2 SHALL APPLY.
2. KEY NEW SIDEWALK SECTION UNDER EXISTING SIDEWALK.
3. PRESATURATION OF SOIL SHALL BE APPROVED BY INSPECTOR.

CITY OF MISSION VIEJO



SIDEWALK DETAILS

STANDARD
PLAN NO.

321

Robert Anderson 9-23-03

 APPROVED RCE 30190 DATE

SHT 3 OF 3

SINGLE RAMP

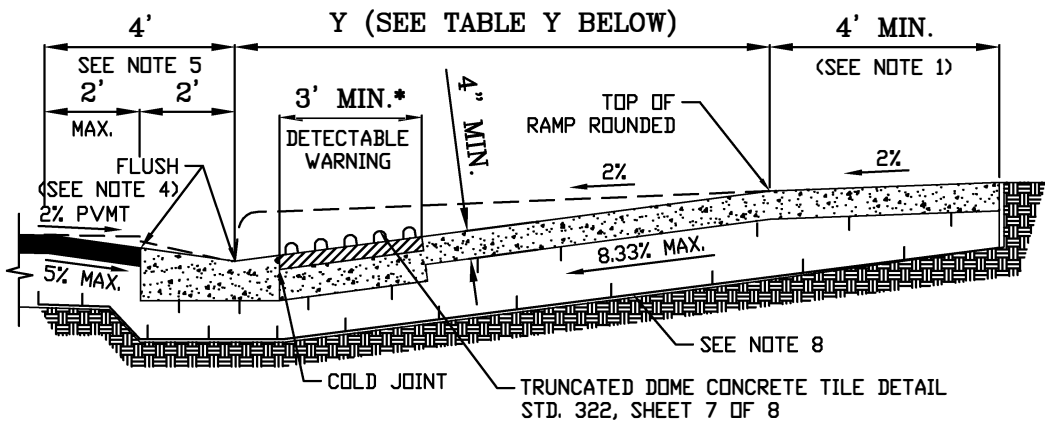
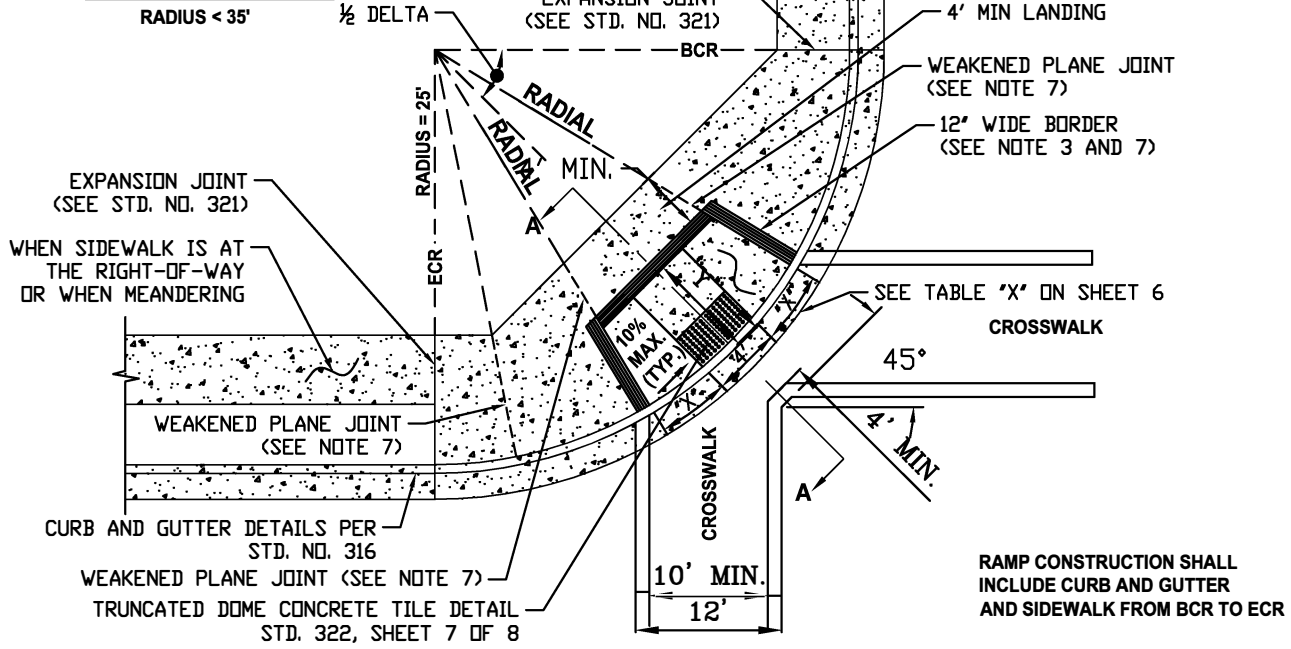

SECTION A - A

SEE SHEET 8 OF 8 FOR NOTES.

TABLE Y

CF	Y*
6'	7.90'
8'	10.53'

$$Y = \frac{\text{CURB FACE (FT.)}}{6.33\%}$$

* 'Y' SHALL NOT EXCEED 10.53', UNLESS APPROVED BY THE CITY ENGINEER

CITY OF MISSION VIEJO

ACCESS RAMPS CASE A

STANDARD
PLAN NO.

322



Rich Johnson

08/01/05

APPROVED BY: CITY ENGINEER RCE 51160

DATE

SHT 1 OF 8

SINGLE RAMP

RADIUS $\leq 25'$
SEE PROFILE SHEET
6 OF 8

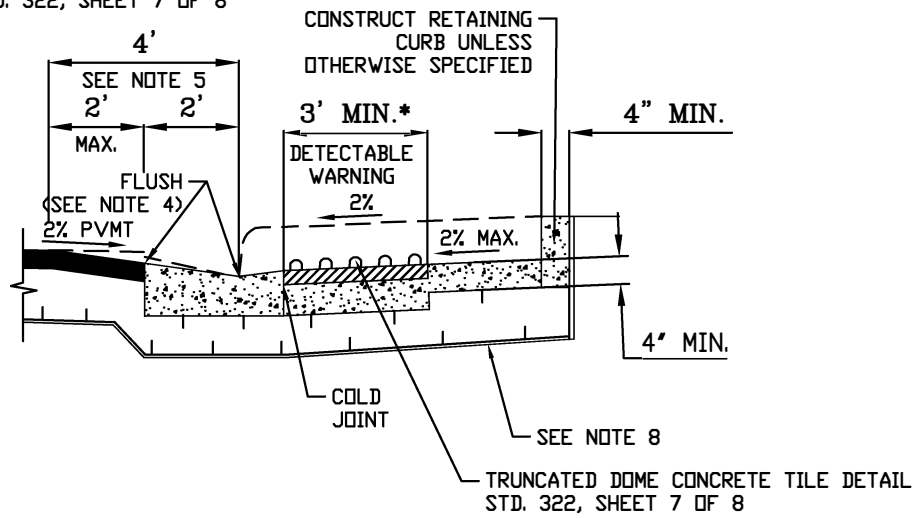
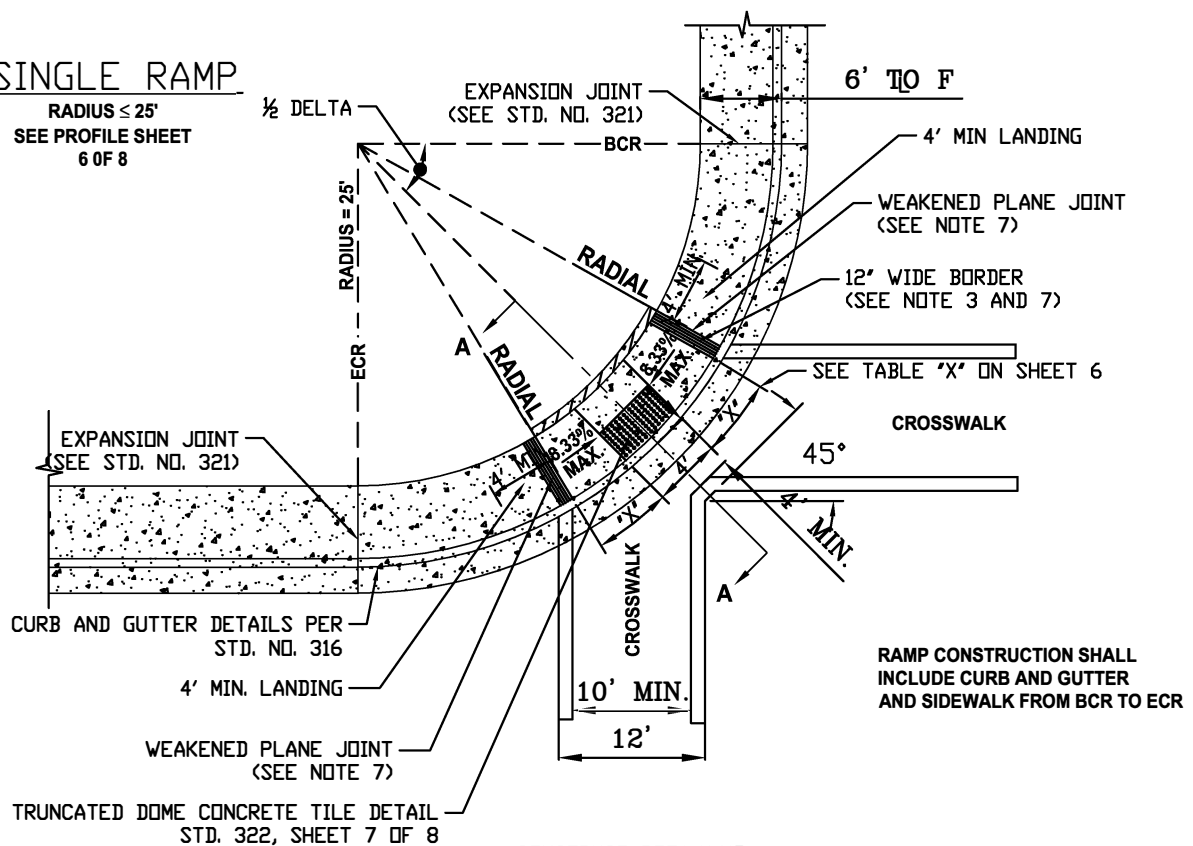

SECTION A - A

SEE SHEET 8 OF 8 FOR NOTES.

CITY OF MISSION VIEJO

ACCESS RAMPS CASE B

STANDARD
PLAN NO.

322



Rich Johnson

08/01/05

APPROVED BY: CITY ENGINEER RCE 51160

DATE

SHT 2 OF 8

****DOUBLE RAMP**

RADIUS ≥ 35'

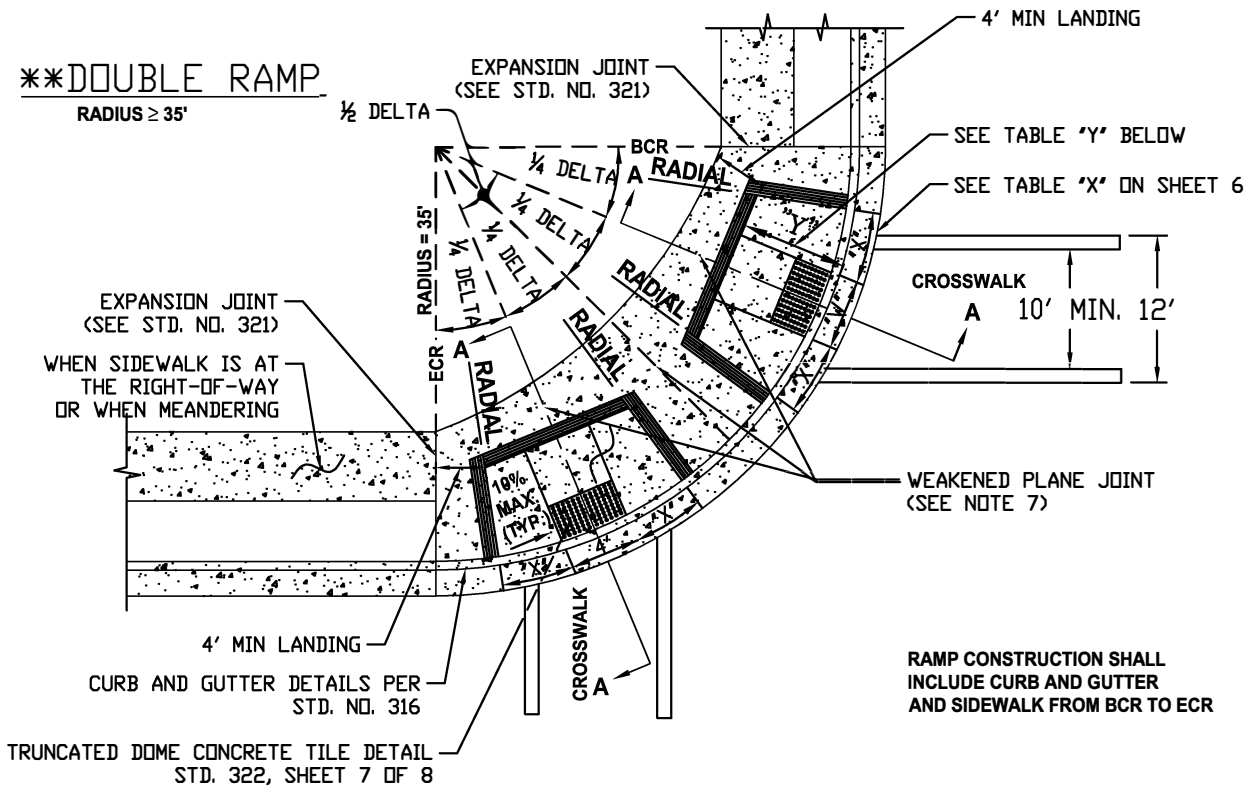

RAMP CONSTRUCTION SHALL INCLUDE CURB AND GUTTER AND SIDEWALK FROM BCR TO ECR

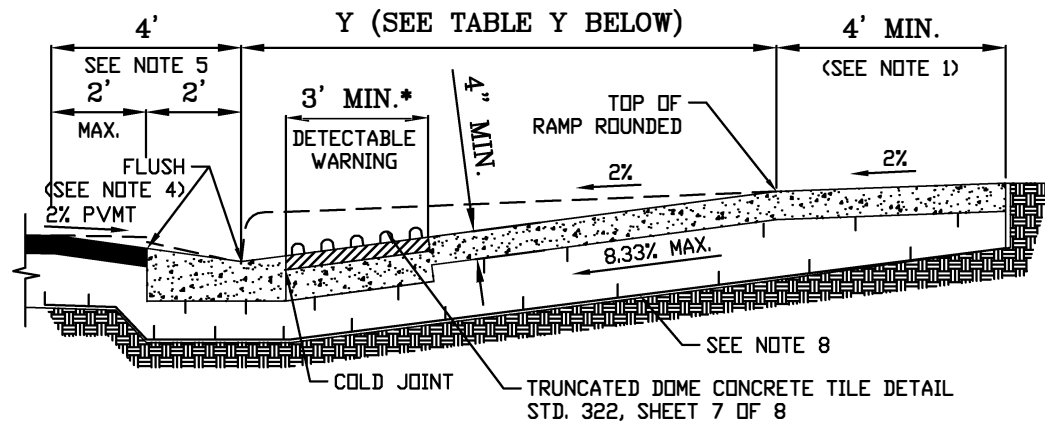

SECTION A - A

SEE SHEET 8 OF 8 FOR NOTES.

TABLE - Y

CF	Y*
6'	7.90'
8'	10.53'

$$Y = \frac{\text{CURB FACE (FT.)}}{6.33\%}$$

* 'Y' SHALL NOT EXCEED 10.53', UNLESS APPROVED BY THE CITY ENGINEER
 ** ELIMINATE ONE RAMP IF NO FUTURE PATH OF TRAVEL EXIST

CITY OF MISSION VIEJO

**ACCESS RAMPS
CASE C**

STANDARD
PLAN NO.

322



Richard J. ...

08/01/05

APPROVED BY: CITY ENGINEER RCE 51160

DATE

SHT 3 OF 8

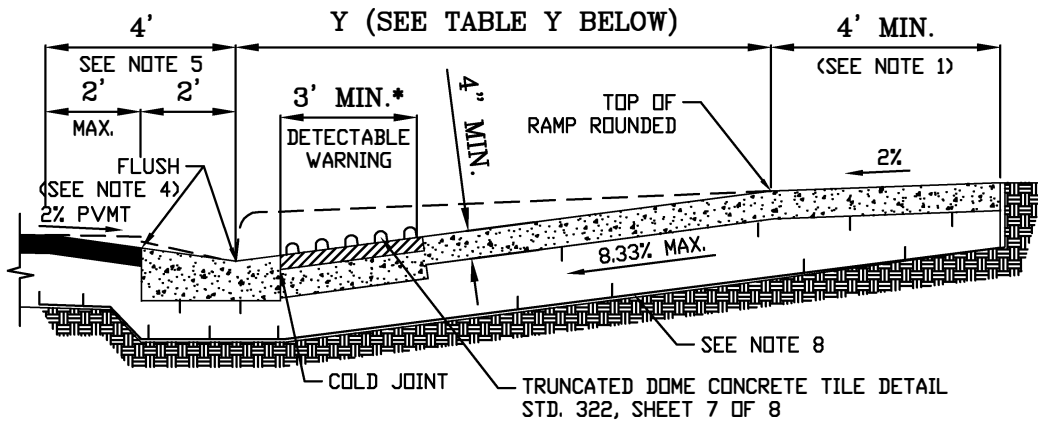
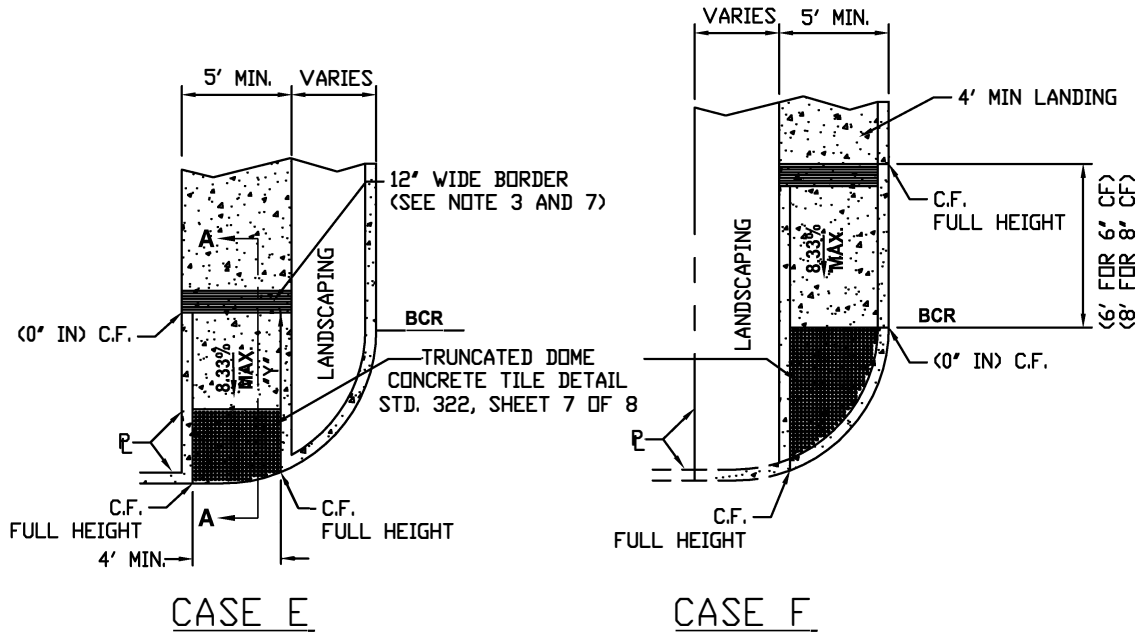

SECTION A - A
SEE SHEET 8 OF 8 FOR NOTES.

$$Y = \frac{\text{CURB FACE (FT.)}}{6.33\%}$$

TABLE - Y

CF	Y*
6'	7.90'
8'	10.53'

* 'Y' SHALL NOT EXCEED 10.53', UNLESS APPROVED BY THE CITY ENGINEER

CITY OF MISSION VIEJO

ACCESS RAMPS CASE E & CASE F

STANDARD
PLAN NO.

322

08/01/05

APPROVED BY: CITY ENGINEER RCE 51160

DATE

SHT 5 OF 8



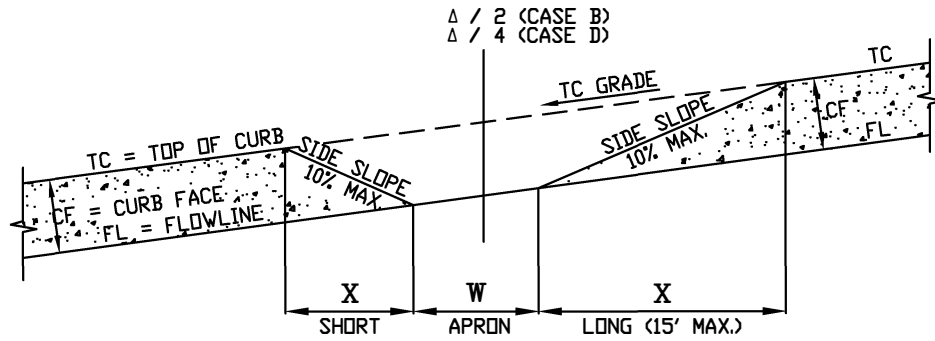

PROFILE
CASE B & D

CF (IN)	RADIUS (FT)	SIDE SLOPE	X	TC GRADE (ALONG CURB RETURN)					
				1%	2%	3%	4%	5%	6%
6'	35'	10%	X _S	4.6	4.2	3.9	3.6	3.4	3.2
			X _L	5.6	6.3	7.2	8.4	10.0	12.5
8'	35'	10%	X _S	6.1	5.6	5.2	4.8	4.5	4.2
			X _L	7.5	8.4	9.6	11.2	13.4	15.0

TABLE - X

TO CALCULATE "X" DIMENSION

SHORT SIDE (DOWN SLOPE): LONG SIDE (UP SLOPE):

$$X_S \text{ (FT)} = \frac{\text{CURBFACE (FT)}}{\text{SIDE SLOPE} + \text{TC GRADE}} \quad X_L \text{ (FT)} = \frac{\text{CURBFACE (FT)}}{\text{SIDE SLOPE} - \text{TC GRADE}}$$

ENGINEER TO SHOW X_S AND X_L ON IMPROVEMENT PLANS

GROOVE DETAIL

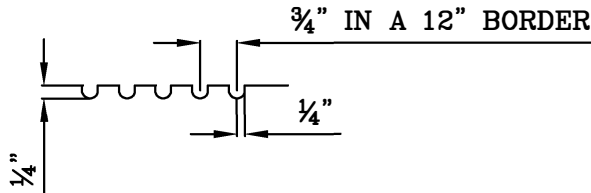

CITY OF MISSION VIEJO



CURB RAMP

STANDARD
PLAN NO.

322

Richard D. Johnson

08/01/05

APPROVED BY: CITY ENGINEER RCE 51160

DATE

SHT 6 OF 8

CONTRAST BORDER WIDTH $\geq 4"$ TYP. (1' MIN. PER CBC)
LIGHT-ON-DARK OR DARK-ON-LIGHT

CONCRETE TILE DETECTABLE
WARNING DOMES, IN-LINE PATTERN
(WAUSAU TILE, ADA-2,
COLOR A-90, OR EQUAL)

AT INTERIOR AND PERIMETER JOINTS
USE STABILIZED POLYMERIC BEDDING
SAND JOINT WIDTH $< \frac{1}{8}"$

LATEX THIN-SET
MORTAR BED
PER MANUFACTURER'S
RECOMMENDATIONS

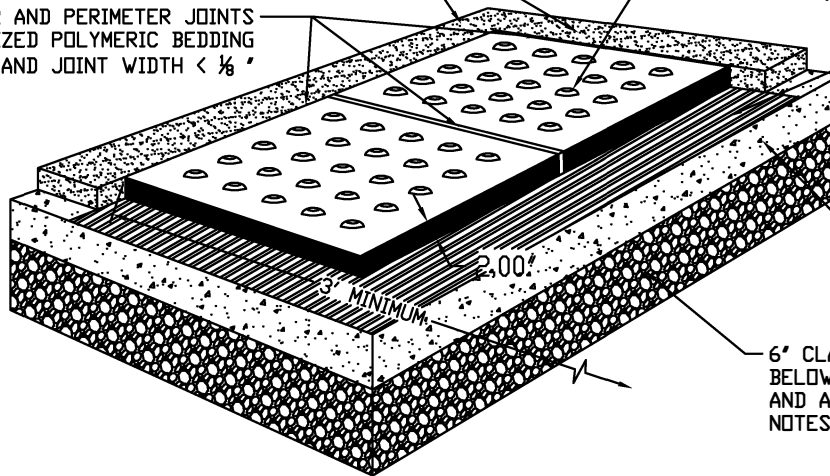

4" CONCRETE
(SEE NOTE 8)

6" CLASS II BASE OR CURB
BELOW CURB RAMP AREA
AND AS SUPPLEMENTED BY THE
NOTES ON STD. 321

ISOMETRIC VIEW

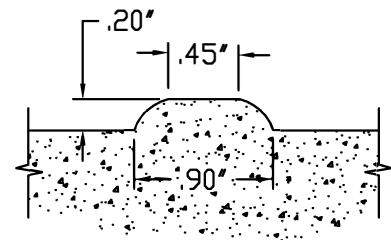
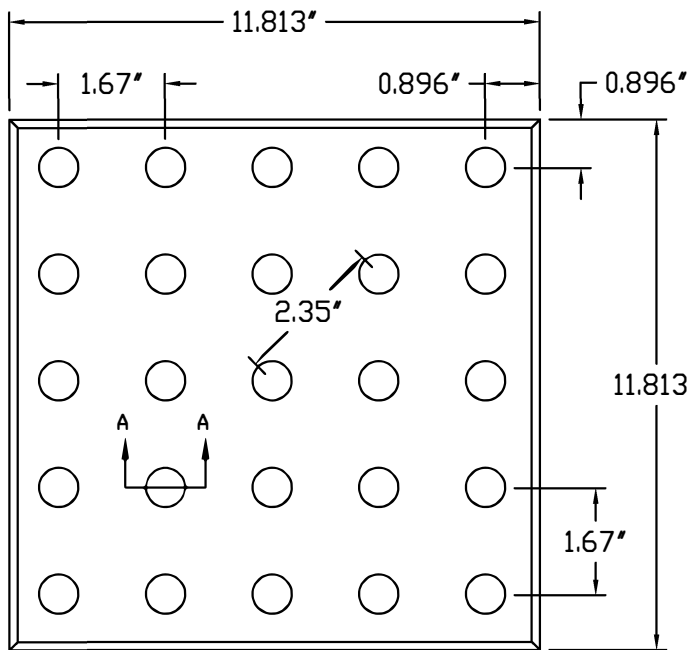

SECTION A - A

CONCRETE TILE DETECTABLE WARNING DOMES

IN-LINE PATTERN
(WAUSAU TILE, TYPE 3, SERIES U4008 OR EQUAL)

CITY OF MISSION VIEJO

**TRUNCATED DOME
CONCRETE TILE DETAIL**

STANDARD
PLAN NO.

322

08/01/05



Rich Doherty

APPROVED BY: CITY ENGINEER RCE 51160

DATE

SHT 7 OF 8

CONSTRUCTION NOTES:

1. IF DISTANCE FROM CURB TO BACK OF SIDEWALK IS TOO SHORT TO ACCOMMODATE RAMP AND 4 FOOT LANDING, THEN USE THE CASE "B" RAMP.
2. IF SIDEWALK IS LESS THAN 6 FEET WIDE, THE FULL WIDTH OF THE SIDEWALK SHALL BE DEPRESSED AS SHOWN IN CASE B. MINIMUM SIDEWALK WIDTH IS 4 FEET FROM BACK OF CURB.
3. THE RAMP SHALL HAVE A 12 INCH WIDE BORDER WITH GROOVES ¼" WIDE AND ¼" DEEP APPROXIMATELY ¾" ON CENTER. SEE GROOVING DETAIL ON SHEET 6 OF 8.
4. TRANSITIONS FROM RAMPS TO WALKS, GUTTERS, OR STREETS SHALL BE FLUSH AND FREE OF ABRUPT CHANGES.
5. MAXIMUM SLOPES OF ADJOINING GUTTERS: THE ROAD SURFACE IMMEDIATELY ADJACENT TO THE CURB RAMP AND CONTINUOUS PASSAGE TO THE CURB RAMP SHALL NOT EXCEED 5% WITHIN 4 FEET OF THE BOTTOM OF THE CURB RAMP.
6. RAMP SIDE SLOPE VARIES UNIFORMLY FROM A MAXIMUM OF UP TO 10% AT CURB TO CONFORM WITH LONGITUDINAL SIDEWALK SLOPE ADJACENT TO TOP OF THE RAMP (EXCEPT IN CASE B).
7. CONSTRUCT EXPANSION JOINTS AT ¼ AND ¾ DELTAS WHEN RADIUS EQUALS 35 FEET, AT INSIDE EDGE OF GROOVED BORDER WHEN RADIUS EQUALS 25 FEET, AND RADIALLY IF ANGLE POINT OCCURS.
8. CONCRETE SPECIFICATION PER CITY STANDARD 200 - CONCRETE SPECIFICATIONS.

DETECTABLE WARNING NOTES:

1. TRUNCATED DOMES SHALL BE WAUSAU TILE, TYPE 3, SERIES U4008 OR EQUAL, IN LINE, PRE-CAST CONCRETE TILES AND GROUTED IN PLACE. NO SURFACE APPLIED DOME MATS ARE ALLOWED UNLESS APPROVED BY CITY ENGINEER. USE STABILIZED POLYMERIC BEDDING SAND AT TRUNCATED DOME TILES AT INTERIOR AND PERIMETER JOINTS. JOINT WIDTH < ⅛".
2. CURB RAMPS REQUIRE DETECTABLE WARNING DOMES FOR THE FULL WIDTH AND THREE (3) FEET IN DEPTH OF THE CURB RAMP SLOPE FROM THE CURB LINE WITHIN THE PUBLIC RIGHT-OF-WAY.
3. PRIVATE (ONSITE) TRUNCATED DOME INSTALLATION TO EXTEND FULL WIDTH AND DEPTH OF RAMP PER CALIFORNIA BUILDING CODE, EXCLUDING PRIVATELY FUNDED SINGLE FAMILY RESIDENCES.
4. THREE RUNNING FEET OF TRUNCATED DOMES AT FLUSH CURB INSTALLATIONS ARE REQUIRED FOR HAZARDOUS VEHICULAR AREAS. BOLLARDS ARE UTILIZED FOR PEDESTRIAN PROTECTION AT FLUSH CURB RETURNS OR EQUIVALENT FACILITIES AS APPROVED BY THE CITY ENGINEER.
5. SUBMIT CONCRETE DOME TILE AND POLYMERIC BEDDING SAND SPECIFICATIONS OR SAMPLES TO THE CITY FOR APPROVAL PRIOR TO INSTALLATION.
6. THE DETECTABLE WARNING SURFACE SHALL BE LOCATED SO THAT THE EDGE NEAREST THE CURB LINE IS 6" FROM THE CURB FACE.
7. MATCH ALL TILE CORNERS SUCH THAT ALL TRUNCATED DOME TILES ALIGN AND MAINTAIN DOME DIMENSIONAL SPACING. TRUNCATED DOME TILES SHALL BE ALIGNED PARALLEL WITH RAMP SLOPE DIRECTION. TRUNCATED DOME TILES CUT TO MATCH CURB RETURN RADIUS. GRIND EDGE TO AVOID TRIP HAZARD, AS REQUIRED.

CITY OF MISSION VIEJO



**CURB RAMP
CONSTRUCTION NOTES**

**STANDARD
PLAN NO.**

322

Rich Doherty

08/01/05

APPROVED BY:

CITY ENGINEER RCE 51160

DATE

SHT 8 OF 8

SECTION 1. MATERIALS

CONCRETE STRENGTH AND CORRESPONDING CONCRETE CLASS FOR ALL CONCRETE STRUCTURES AND OTHER MISCELLANEOUS CONCRETE WORK SHALL CONFORM TO THE REQUIREMENTS OF SECTION 201-1.1.2 (REFER TO TABLE 201-1.1.2) AND SECTION 201-1.1.3 (REFER TO TABLE 201-1.1.3) OF THE GREENBOOK. IN ADDITION, PORTLAND CEMENT CONCRETE SHALL CONFORM TO THE REQUIREMENTS OF SECTION 201-1, "PORTLAND CEMENT CONCRETE", OF THE GREENBOOK AND THESE SPECIAL PROVISIONS.

AGGREGATE USED IN CONCRETE SHALL NOT CONTAIN ANY DELETERIOUS AMOUNTS OF GYPSUM, PYRITE, ZEOLITES, OR ANY UNSTABLE OR AMORPHOUS SILICA INCLUDING AMOUNTS EXCEEDING 5 PERCENT OPTICALLY STRAINED, HIGHLY METAMORPHIC, MICROFRACTURED, MICROCRYSTALLINE OR CRYPTOCRYSTALLINE QUARTZ; 1 PERCENT TRIDYMITITE OR CRISTOBALITE; 3 PERCENT CHERT, CHALCEDONY, VOLCANIC GLASS OR SYNTHETIC GLASS; OR 0.5 PERCENT OPAL.

THE CEMENT TYPE REQUIREMENT, SECTION 201-1.2.1, "CEMENT", SHALL BE TYPE II, III, V OR IP (MS) AS DETERMINED BY THE ENGINEER. TYPE II, III, V OR IP (MS) CEMENTS SHALL CONFORM TO ASTM C150 AND THE LOW ALKALI REQUIREMENTS OF TABLE IA THEREIN. TYPE IP (MS) CEMENT SHALL ALSO CONFORM TO THE REQUIREMENTS FOR TYPE IP (MS) CEMENT OF ASTM C595, AND SHALL BE COMPRISED OF AN INTIMATE MIXTURE OF TYPE II CEMENT AND NOT MORE THAN 20 PERCENT BY MASS OF A POZZOLANIC MATERIAL.

FOR THE MITIGATION OF ALKALI-SILICA REACTION POTENTIAL, 20 PERCENT BY MASS OF THE REQUIRED PORTLAND CEMENT IN CONCRETE SHALL BE REPLACED WITH FLY ASH: UP TO A TOTAL OF 30 PERCENT FLY ASH OF THE REQUIRED PORTLAND CEMENT MAY BE USED IN A PREQUALIFIED MIX DESIGN PER SECTION 201-1.1.4, "CONCRETE SPECIFIED BY COMPRESSIVE STRENGTH", OF THE GREENBOOK. THE TOTAL MASS OF PORTLAND CEMENT MAY BE REDUCED BY 5 PERCENT IF AN APPROVED WATER REDUCER IS ADDED. FLY ASH SHALL CONFORM TO SECTION 201-1.2.5.3, "FLY ASH". (NOTE: THE CEMENT TOTAL MASS OF PORTLAND CEMENT AND 20 PERCENT FLY ASH AND APPROVED WATER REDUCER SHALL BE THE SAME AS FOUND IN THE "CONCRETE CLASS" PORTION OF TABLE 201-1.1.2 IN SECTION 201-1.1.2, "CONCRETE SPECIFIED BY CLASS AND ALTERNATE CLASS".

CONCRETE SPECIFIED BY ALTERNATE CLASS SHALL BE PER SECTION 201-1 AND TABLE 201-1.1.2 EXCEPT THAT WHERE FLY ASH IS USED OR REQUIRED AND ADDITIONAL FLY ASH EQUAL TO 5 PERCENT OF THE REQUIRED PORTLAND CEMENT MASS SHALL BE ADDED TO AMOUNTS LISTED IN THE TABLE FOR ALTERNATE CLASS. ALTERNATE CLASS CONCRETE WHICH WILL BE USED FOR NON-STRUCTURAL APPLICATIONS-I.E. PAVEMENT, CURB, GUTTER, SIDEWALKS PIPE BEDDING, BACKFILL, CLSM, ETC.-MAY ALSO INCLUDE RECLAIMED CONCRETE MATERIAL IN ACCORDANCE WITH SECTION V. RECLAIMED HYDRAULIC CONCRETE OF THESE SPECIAL PROVISIONS.

POZZOLAN SHALL CONFORM TO ASTM C618, CLASS F. CLASS C FLY ASH MAY BE USED IF APPROVED BY THE OCPW ENGINEER OR GEOTECHNICAL ENGINEER, IN ACCORDANCE WITH SECTION 201-1.2.5, "SUPPLEMENTARY CEMENTITIOUS MATERIALS".

IN DETERMINING THE MAXIMUM AMOUNT OF FREE WATER THAT MAY BE USED IN CONCRETE, POZZOLAN SHALL BE CONSIDERED TO BE CEMENT. IN DETERMINING THE AMOUNT OF TOTAL CEMENT, CEMENT SHALL BE THE TOTAL MASS OF FLY ASH AND PORTLAND CEMENT.

COUNTY OF ORANGE, OC PUBLIC WORKS DEPARTMENT

Approved

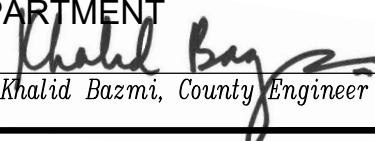
Khalid Bazmi, County Engineer

Revision: August 2018

STD. PLAN

1803

SPECIAL PROVISION - PORTLAND CEMENT CONCRETE

SHT. 1 OF 9

THE TOTAL AMOUNT OF PORTLAND CEMENT IN THE TOTAL MASS SHALL NOT EXCEED 700 LBS. PER CUBIC YARD. THE CLEANNESS VALUE REQUIREMENT OF SECTION 200-1.4, "COARSE AGGREGATE FOR PORTLAND CEMENT CONCRETE", SHALL BE REPLACED WITH THE FOLLOWING:

<u>TESTS</u>	<u>TEST METHOD</u>	<u>REQUIREMENTS</u>
CLEANNESS VALUE	CALIF. 227	
INDIVIDUAL TEST		70 MIN.
MOVING AVERAGE		75 MIN.

THE SAND EQUIVALENT REQUIREMENT OF SECTION 200-1.5.3, "SAND FOR PORTLAND CEMENT CONCRETE", SHALL BE REPLACED WITH THE FOLLOWING:

<u>TESTS</u>	<u>TEST METHOD</u>	<u>REQUIREMENTS</u>
SAND EQUIVALENT	CALIF. 217	
INDIVIDUAL TEST		70 MIN.
MOVING AVERAGE		75 MIN.

EVALUATION OF MOVING AVERAGE FOR SAND EQUIVALENT AND CLEANNESS VALUE RESULTS SHALL CONFORM TO THE PROVISIONS OF SECTION 200-1.1.2, "STATISTICAL TESTING".

IN LIEU OF THE PROVISIONS OF SECTION 300-11.3.1, "CONCRETE" FOR CONCRETED (GROUTED) STONE SLOPE PROTECTION (RIPRAP) SHALL BE 650-EFW-3250P.

SECTION II. GENERAL PROVISIONS

ADD TO SECTION 303-1.2, "SUBGRADE FOR CONCRETE STRUCTURES", OF THE GREENBOOK, THE FOLLOWING: IF THE PLANS AND SPECIFICATIONS FOR THE PROJECT PROVIDE FOR THE CONSTRUCTION OF GRAVEL (DRAIN) MATERIAL, WHICH WILL BE THE SUBGRADE FOR THE CONCRETE, CONTRACTOR SHALL FURNISH NON-WOVEN FILTER FABRIC TYPE I PER OCPW STANDARD PLAN 1808 ON TOP OF THE GRAVEL (DRAIN) MATERIAL AS A SEPARATOR. THE PLACEMENT OF STEEL REINFORCEMENT AND OF CONCRETE SHALL FOLLOW THE INSTALLATION OF THE GEOTEXTILE FABRIC AS CLOSELY AS POSSIBLE. THE GRAVEL (DRAIN) MATERIAL SHALL BE KEPT FREE FROM WATER TO PREVENT ANY PORTION OF CONCRETE MATERIAL BEING DEPOSITED IN WATER.

A RANGE OF LOCALLY AVAILABLE GRADATIONS, D1 THROUGH D5, IS GIVEN IN THE TABLE BELOW FOR SELECTION BY THE DESIGN ENGINEER FOR COMPATIBILITY WITH THE SUBGRADE. IF NO GRADATION OR THICKNESS IS SPECIFIED, THE GRAVEL (DRAIN) SHALL BE 1.0 FOOT THICK AND D3 GRADING.

THE CONTRACTOR SHALL PLACE GRAVEL (DRAIN) MATERIAL UNDER CONCRETE CHANNEL CULVERT INVERTS, PIER EXTENSION AND RETAINING WALL FOOTINGS, AND OTHER LOCATIONS AS SHOWN ON THE PLANS, IN ORDER TO PROVIDE A STABLE SUBGRADE AND TO PERMIT THE FLOW OF GROUNDWATER.

COUNTY OF ORANGE, OC PUBLIC WORKS DEPARTMENT

Approved

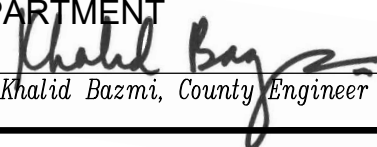
Khalid Bazmi, County Engineer

Revision: August 2018

STD. PLAN

1803

SPECIAL PROVISION - PORTLAND CEMENT CONCRETE

SHT. 2 OF 9

THE COMPOSITION OF GRAVEL (DRAIN) MATERIAL SHALL CONFORM TO THE FOLLOWING GRADING REQUIREMENTS WHEN DETERMINED BY CALIFORNIA TEST METHOD 202:

SCREEN OR SIEVE SIZE	D1	D2	D3	D4	D5
3"		100	100	100	100
1 1/2"	100	95-100	90-100	90-100	85-100
1"			65-100		5-60
3/4"	90-100	50-100	50-90	20-60	0-30
3/8"	60-100	15-55	0-50	0-20	0-5
No. 4	5-50	0-25	0-10	0-5	
No. 8	0-10		0-5		
No. 16	0-5				
No. 200		0-3			
APPROXIMATE	(No. 4 ROCK)	(No. 3 & No. 4 1:1)	(No. 3 ROCK)	(No. 2 & No. 3 1:1)	(No. 2 ROCK)

THE APPROXIMATE COMPOSITIONS ARE GIVEN FOR INFORMATION PURPOSES ONLY; THE GRADING LIMITS SPECIFIED ABOVE SHALL CONTROL.

THE CONTRACTOR SHALL EXCAVATE TO THE SUBGRADE DIMENSIONS AND GRADES SHOWN ON THE PLANS OR AS DIRECTED BY THE ENGINEER. WHERE POOR SOIL CONDITIONS ARE ENCOUNTERED DUE TO SOFT, SPONGY OR OTHER UNSTABLE MATERIAL OR BY GROUNDWATER, ALL SUCH UNSTABLE MATERIAL SHALL BE REMOVED AND REPLACED WITH GRAVEL (DRAIN) MATERIAL, COMPACTED BACKFILL, AND CONTRACTOR SHALL PLACE A NON-WOVEN FILTER FABRIC TYPE II PER OCPW STANDARD PLAN 1808 BELOW THE GRAVEL (DRAIN) MATERIAL AS A SEPARATOR, AT THE DIRECTION OF THE ENGINEER.

ADD TO SECTION 303-1.3, "FORMS", THE FOLLOWING: TANGENT SECTIONS FOR FORMED WALL SURFACE SHALL RESULT IN CONCRETE SURFACE 1 FREE OF ANY UNEVENNESS GREATER THAN 1/4 INCH WHEN CHECKED WITH A TEN FOOT STRAIGHTEDGE.

FORMS FOR COVERED CONDUIT OR OPEN CHANNEL CURVED SECTIONS SHALL BE CONSTRUCTED ALONG THE ARC OF THE CURVE. THE FINISHED SURFACE SHALL FOLLOW THE ARC OF THE CURVE.

IF PERMITTED BY THE ENGINEER, COVERED CONDUIT CURVED SECTIONS MAY USE CHORD PANEL. ENDS OF THE CHORD PANEL SHALL BE ON THE ARC OF THE CURVE.

COUNTY OF ORANGE, OC PUBLIC WORKS DEPARTMENT

Approved

Khalid Bazmi
Khalid Bazmi, County Engineer

Revision: August 2018

STD. PLAN

1803

SHT. 3 OF 9

SPECIAL PROVISION - PORTLAND CEMENT CONCRETE

ADD TO SECTION 303-1.7.1, "GENERAL", OF THE GREENBOOK, THE FOLLOWING:

REINFORCING STEEL SHALL BE GRADE 60, NEW BILLET STEEL, CONFORMING TO ASTM A615, AND SHALL BE OF THE SAME GRADE THROUGHOUT THE STRUCTURE. ALUMINUM AND PLASTIC SUPPORTS FOR REINFORCEMENT SHALL NOT BE USED. ONLY CONCRETE (DOBIES) STEEL REINFORCEMENT SUPPORTS SHALL BE USED UNLESS OTHERWISE SPECIFIED BY THE ENGINEER.

BARs SHALL BE ACCURATELY SPACED AS SHOWN ON THE PLANS, AND SPACING OF THE FIRST BAR IMMEDIATELY ADJACENT TO A TRANSVERSE CONSTRUCTION JOINT SHALL BE ONE-HALF THE REQUIRED SPACING SHOWN ON THE PLANS. IN NO CASE SHALL THE CLEAR DISTANCE BETWEEN PARALLEL BARs BE LESS THAN 2.5 DIAMETERS OF THE BAR OR A MINIMUM OF TWO INCHES.

UNLESS OTHERWISE SHOWN ON THE PLANS, EMBEDMENT OF REINFORCING STEEL (OTHER THAN STIRRUPS) SHALL BE 1½ INCHES CLEAR FOR #8 BARs AND SMALLER, AND SHALL BE TWO INCHES CLEAR FOR #9 BARs OR LARGER. WHERE PLACEMENT OF REINFORCING STEEL REQUIRES ALTERNATE BARs OF DIFFERENT SIZE, EMBEDMENT REQUIREMENTS SHALL BE GOVERNED BY THE LARGER BAR. STIRRUPS AND SPACERS SHALL BE EMBEDDED NOT LESS THAN ONE INCH CLEAR DEPTH. MEASUREMENT OF EMBEDMENT SHALL BE FROM THE OUTSIDE OF THE BAR TO THE NEAREST CONCRETE FACE.

TACK WELDING OR BUTT WELDING IN REINFORCING BARs WILL NOT BE PERMITTED. HOWEVER, MECHANICAL BUTT SPLICING PER SECTION 52-6.03C(2), "MECHANICAL SPLICES", OF THE CALIFORNIA DEPARTMENT OF TRANSPORTATION STANDARD SPECIFICATION MAY BE ALLOWED AT THE DISCRETION OF THE ENGINEER.

ADD TO SECTION 303-1.7.2, "SPLICING", THE FOLLOWING: REINFORCING BARs MAY BE CONTINUOUS AT LOCATIONS WHERE SPLICES ARE SHOWN ON THE PLANS, AT THE OPTION OF THE CONTRACTOR. THE LOCATION OF SPLICES, EXCEPT WHERE SHOWN ON THE PLANS, SHALL BE DETERMINED BY THE CONTRACTOR AS APPROVED BY THE ENGINEER BASED UPON USING AVAILABLE COMMERCIAL LENGTHS WHERE PRACTICABLE.

UNLESS OTHERWISE SHOWN ON THE PLANS OR APPROVED BY THE ENGINEER, SPLICES IN ADJACENT REINFORCING BARs SHALL BE STAGGERED. THE MINIMUM DISTANCE BETWEEN STAGGERED SPLICES FOR REINFORCING BARs #11 OR SMALLER SHALL BE THE LENGTH REQUIRED FOR A LAPPED SPLICE IN THE BAR.

SPLICES SHALL CONSIST OF PLACING THE REINFORCING BARs IN CONTACT AND WIRING THEM TOGETHER IN SUCH A MANNER AS TO MAINTAIN THE ALIGNMENT OF THE BARs AND TO PROVIDE MINIMUM CLEARANCES. THICKNESS GREATER THAN SIX (6) INCHES SHALL BE KEYED AS SHOWN ON THE PLANS OR AS DIRECTED BY THE ENGINEER.

NO LAPPED SPLICES WILL BE PERMITTED AT LOCATIONS WHERE THE CONCRETE SECTION IS NOT SUFFICIENT TO PROVIDE MINIMUM CLEAR DISTANCE OF TWO INCHES BETWEEN THE SPLICE AND THE NEAREST ADJACENT BAR. THE CLEARANCE TO THE SURFACE OF THE CONCRETE SHALL NOT BE REDUCED.

COUNTY OF ORANGE, OC PUBLIC WORKS DEPARTMENT

Approved

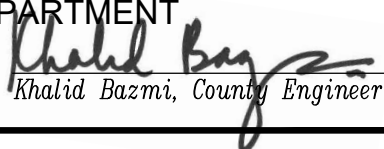
Khalid Bazmi, County Engineer

Revision: August 2018

STD. PLAN

1803

SPECIAL PROVISION - PORTLAND CEMENT CONCRETE

SHT. 4 OF 9

THE LENGTH OF LAPPED SPLICES SHALL BE AS FOLLOWS: REINFORCING BARS #8 OR SMALLER, SHALL BE LAPPED AT LEAST 45 DIAMETERS OF THE SMALLER BAR JOINED, AND REINFORCING BARS #9, #10, AND #11 SHALL BE LAPPED AT LEAST 60 DIAMETERS OF THE SMALLER BAR JOINED, EXCEPT WHEN OTHERWISE SHOWN ON THE PLANS.

WHERE BUNDLED BARS ARE SPECIFIED, SPLICES SHALL CONFORM TO THE FOLLOWING:

1. IN BUNDLES OF TWO BARS, THE LENGTH OF LAPPED SPLICE SHALL BE 1.2 TIMES THE LENGTH OF SINGLE BAR LAPPED SPLICE.
2. IN BUNDLES OF THREE BARS, THE LENGTH OF LAPPED SPLICE SHALL BE 1.33 TIMES THE LENGTH OF SINGLE BAR LAPPED SPLICE.

SPIRAL REINFORCEMENT SHALL BE LAPPED AT LEAST 80 DIAMETERS. SPIRAL REINFORCEMENTS AT SPLICES AND AT ENDS SHALL BE TERMINATED BY A 135 DEGREE HOOK WITH A 10 INCH HOOK AROUND AN INTERSECTING BAR.

SPLICES OF TENSILE REINFORCEMENT AT POINTS OF MAXIMUM STRESS SHALL BE AVOIDED; HOWEVER, ANY PROPOSED DEVIATION FROM SPLICES SHOWN ON THE PLANS SHALL BE SUBMITTED TO THE ENGINEER FOR APPROVAL.

ADD TO SECTION 303-1.8, "PLACING CONCRETE", THE FOLLOWING:

1. CONCRETE FOR GIRDER SPANS SHALL BE PLACED IN NOT LESS THAN TWO OPERATIONS.
2. THE LAST OPERATION SHALL CONSIST OF PLACING THE TOP DECK SLAB.
3. AT LEAST FIVE DAYS SHALL ELAPSE BETWEEN EACH OPERATION, UNLESS OTHERWISE PERMITTED BY THE ENGINEER.

WHEN CONCRETE IS TO BE DEPOSITED IN A MEMBER LESS THAN 16 INCHES IN WIDTH, THE USE OF DOUBLE BELTING TO PREVENT SEGREGATION OF THE CONCRETE SHALL BE PERMITTED. IN LIEU OF PIPES OR TREMIES, EACH BELT SHALL EXTEND EQUIDISTANT INTO THE FORMS TO A POINT WHERE CONCRETE SHALL NOT FALL MORE THAN SIX FEET. WHEN PLACED IN THE FORMS, THE BELTS SHALL BE ALIGNED DIRECTLY OPPOSITE EACH OTHER.

ADD TO SECTION 303-1.8.6, "JOINTS", THE FOLLOWING:

UNLESS OTHERWISE SPECIFIED, TRANSVERSE CONSTRUCTION JOINTS SHALL BE PLACED IN ALL REINFORCED SECTIONS AT INTERVALS OF NOT LESS THAN 10 FEET OR MORE THAN 50 FEET. THE JOINTS SHALL BE IN THE SAME PLANE FOR THE ENTIRE STRUCTURE, AND FOR CONCRETE THICKNESS GREATER THAN 6 INCHES SHALL BE KEYED AS DIRECTED BY THE ENGINEER.

CONSTRUCTION OF ALL REINFORCED CONCRETE SECTIONS (INCLUDING INVERTS) SHALL BE BY THE ALTERNATE PANEL METHOD, AND NO CONTINUOUS PLACEMENT THROUGH JOINTS WILL BE PERMITTED. AFTER PLACEMENT OF ALL CONCRETE IN A PANEL OR A SECTION ON ONE SIDE OF THE JOINT HAS BEEN COMPLETED, PLACEMENT OF CONCRETE ON THE OTHER SIDE OF THE JOINT SHALL BE DELAYED AS DIRECTED BY THE ENGINEER; BUT IN NO EVENT SHALL THE DELAY BE LESS THAN EIGHT HOURS.

IN LIEU OF SAW CUTTING, AS SPECIFIED IN SECTION 201-3 "EXPANSION JOINT FILLER AND JOINT SEALANTS", JOINT SEALANT GROOVES SHALL BE FORMED AS SHOWN ON THE PLANS AND AS DIRECTED BY THE ENGINEER.

COUNTY OF ORANGE, OC PUBLIC WORKS DEPARTMENT

Approved

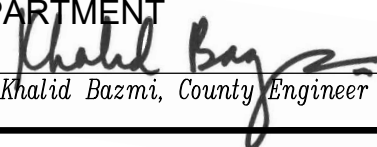
Khalid Bazmi, County Engineer

Revision: August 2018

STD. PLAN

1803

SPECIAL PROVISION - PORTLAND CEMENT CONCRETE

SHT. 5 OF 9

ADD TO SECTION 303-1.9, "SURFACE FINISHES", THE FOLLOWING:

THE LONGITUDINAL AND TRANSVERSE CHANNEL INVERT ELEVATION SHALL NOT VARY FROM TRUE LINE AND GRADE MORE THAN ½ INCH. THE UNEVENNESS SHALL NOT BE MORE THAN ¼ INCH WHEN CHECKED WITH A 10-FOOT STRAIGHTEDGE. TOP OF CHANNEL WALL AND CHANNEL SIDE SLOPE ELEVATION SHALL NOT VARY FROM TRUE LINE AND GRADE MORE THAN ½ INCH. UNEVENNESS SHALL NOT BE MORE THAN ½ INCH WHEN CHECKED WITH A 10-FOOT STRAIGHTEDGE.

ANY SURFACES WHICH FAIL TO CONFORM TO THE ABOVE TOLERANCES SHALL BE GROUND IN ACCORDANCE WITH THE BEST STANDARD PRACTICE UNTIL TOLERANCES ARE MET. GRINDING SHALL NOT REDUCE THE CONCRETE COVER ON REINFORCING STEEL TO LESS THAN 1½ INCHES. PORTIONS OF INVERTS WHICH CANNOT BE CORRECTED SATISFACTORILY BY GRINDING SHALL BE REMOVED AND REPLACED.

EXCEPT AS SPECIFIED ABOVE, VERTICAL OR HORIZONTAL POSITION OF STRUCTURES AS SHOWN ON THE PLANS OR AS SPECIFIED IN THESE SPECIFICATIONS, SHALL NOT VARY MORE THAN ½ INCH FROM TRUE POSITION. ELEVATION AT INLET LIPS SHALL NOT VARY MORE THAN ¼ INCH FROM ELEVATIONS SHOWN ON THE PLANS WHEN CHECKED WITH A 10-FOOT STRAIGHTEDGE.

THE 10-FOOT STRAIGHTEDGE OR TEMPLATE SHALL BE FURNISHED BY THE CONTRACTOR AND SHALL BE READILY AVAILABLE PRIOR TO PLACING CONCRETE.

ADD TO SECTION 303-1.9.2, "ORDINARY SURFACE FINISH", THE FOLLOWING:

ORDINARY SURFACE FINISH SHALL NOT APPLY TO ROCK POCKETS WHICH, IN THE OPINION OF THE ENGINEER, ARE OF SUCH AN EXTENT OR CHARACTER AS TO AFFECT THE STRENGTH OF THE STRUCTURE MATERIALLY OR TO ENDANGER THE LIFE OF THE STEEL REINFORCEMENT. IN SUCH CASES, THE ENGINEER MAY DECLARE THE CONCRETE DEFECTIVE AND REQUIRE THE REMOVAL AND REPLACEMENT OF THE PORTION OF THE STRUCTURE AFFECTED.

ADD TO SECTION 303-5.5.1, "GENERAL", THE FOLLOWING:

THE TOP AND FACE OF THE FINISHED CURB SHALL BE TRUE AND STRAIGHT, AND THE TOP SURFACE SHALL BE OF UNIFORM WIDTH, FREE FROM HUMPS, SAGS, OR OTHER IRREGULARITIES. WHEN A 10-FOOT STRAIGHTEDGE IS LED ON THE TOP OR FACE OF THE CURB, OR ON THE SURFACE OF THE GUTTERS, THE SURFACE SHALL NOT VARY MORE THAN 0.01-FOOT FROM THE EDGE OF THE STRAIGHTEDGE, EXCEPT AT GRADE CHANGES OR CURVES.

SECTION III. REQUIREMENTS FOR SEA WATER OR SULFATE SOILS CONTACT

UNLESS OTHERWISE SHOWN ON THE PLANS OR AS REQUIRED IN THE SPECIAL PROVISIONS, THE MANUFACTURE AND CURING OF PORTLAND CEMENT CONCRETE UNDER THE FOLLOWING CONDITIONS SHALL APPLY:

A PROPOSED MIX DESIGN SHALL BE SUBMITTED TO THE OCPW ENGINEER OR GEOTECHNICAL ENGINEER FOR APPROVAL. THIS MIX DESIGN SHALL HAVE THE FOLLOWING CHARACTERISTICS:

COUNTY OF ORANGE, OC PUBLIC WORKS DEPARTMENT

Approved

Khalid Bazmi, County Engineer

Revision: August 2018

STD. PLAN

1803

SPECIAL PROVISION - PORTLAND CEMENT CONCRETE

SHT. 6 OF 9

A. GENERAL:

1. THE THICKNESS OF CONCRETE OVER THE REINFORCEMENT SHALL BE 3 INCHES WHERE THE CONCRETE IS DEPOSITED AGAINST THE EARTH WITHOUT FORMS, AND 2 INCHES IF FORMED.
2. FORMS SHALL NOT BE REMOVED PRIOR TO 24 HOURS AFTER CONCRETE PLACEMENT AND IN NO EVENT SOONER THAN AS SPECIFIED IN SECTIONS 303-1.4.5, "CHANNELS AND ARCH SECTIONS" AND SECTION 303-1.5, "REMOVAL OF FORMS FOR CAST-IN-PLACE REINFORCED CONCRETE BOX (CIPRCB) SECTIONS".
3. SOIL SULFATE CONTENT SHALL BE DETERMINED BY CALIFORNIA TEST METHOD 417 (1978) MODIFIED TO A 10:1 DILUTION.

B. SEA WATER OR BRACKISH WATER CONTACT:

1. CONCRETE SHALL BE 800-CSE-5000, TYPE V CEMENT.
2. THE CEMENT CONTENT SHALL INCLUDE 20 PERCENT CLASS F FLY ASH.
3. THE WATER:CEMENT RATIO SHALL BE 0.40.
4. THE MIX SHALL CONTAIN REINFORCING FIBERS IN ACCORDANCE WITH MANUFACTURER INSTRUCTIONS.

C. MODERATE EXPOSURE SULFATE SOILS CONTACT:

SOLUBLE SO₄ CONTENT OF SOIL FROM 1,500 TO 10,000 PPM :

1. CONCRETE SHALL BE 658-CME-4500P, TYPE V CEMENT
2. A SUBSTITUTION OF 20 PERCENT CLASS F FLY ASH OF THE REQUIRED CEMENT CONTENT SHALL BE MADE
3. THE WATER:CEMENT RATIO SHALL BE 0.45
4. CONCRETE SPECIFIED BY SPECIAL EXPOSURE, TABLE 201-1.1.3, MODERATE EXPOSURE.

D. SEVERE EXPOSURE SULFATE SOILS CONTACT:

SOLUBLE SO₄ CONTENT OF SOIL THAT EXCEEDS 10,000 PPM:

1. CONCRETE SHALL BE 750-CSE-5000P, TYPE V CEMENT
2. A SUBSTITUTION OF 20 PERCENT CLASS F FLY ASH OF THE REQUIRED CEMENT CONTENT SHALL BE MADE
3. THE WATER:CEMENT RATIO SHALL BE 0.40
4. CONCRETE SPECIFIED BY SPECIAL EXPOSURE, TABLE 201-1.1.3, SEVERE EXPOSURE.

COUNTY OF ORANGE, OC PUBLIC WORKS DEPARTMENT

Approved

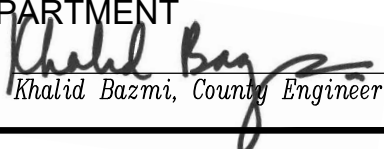
Khalid Bazmi, County Engineer

Revision: August 2018

STD. PLAN

1803

SPECIAL PROVISION - PORTLAND CEMENT CONCRETE

SHT. 7 OF 9

SECTION IV. AIR PLACED CONCRETE

AIR-PLACED CONCRETE SHALL COMPLY WITH SECTION 303-2, "AIR-PLACED CONCRETE", AND THESE SPECIAL PROVISIONS. CONCRETE SPECIFIED BY CLASS AND ALTERNATE CLASS, TABLE 201-1.1.2, AIR PLACED CONCRETE, METHOD B. THE CONCRETE CLASS SHALL BE 650-EFW-3250P.

THE STRENGTH OF AIR-PLACED CONCRETE SHALL BE DETERMINED FROM CORES CUT FROM TEST PANELS IN ACCORDANCE WITH THE FOURTH PARAGRAPH OF SECTION 303-2.4, "TESTS."

SECTION V. RECLAIMED HYDRAULIC CONCRETE

RECLAIMED CONCRETE MATERIAL MAY BE USED IN CONCRETE MIXTURES IN ACCORDANCE WITH THIS SECTION WHEN APPROVED BY THE OCPW ENGINEER OR GEOTECHNICAL ENGINEER. RECLAIMED CONCRETE MATERIAL MAY BE EITHER:

1. RECLAIMED PLASTIC PORTLAND CEMENT CONCRETE (RPPCC)
OR
2. RECLAIMED NON-PLASTIC PORTLAND CEMENT CONCRETE MATERIALS

THE CONTRACTOR IS REQUIRED TO MAINTAIN SUITABLE EQUIPMENT TO CLASSIFY, DOCUMENT, AND PROPORTION RECLAIMED CONCRETE MATERIAL USED IN CONCRETE MIXTURES. THE ADDITION AND CHARACTERISTICS OF RECLAIMED CONCRETE MATERIAL WILL BE MONITORED IN SUCH A MANNER SO TO ENSURE THAT THE FINAL PORTLAND CEMENT CONCRETE COMPOSITE CONFORMS TO THE SPECIFICATIONS FOR ITS CLASS AND USE. THE OCPW ENGINEER OR GEOTECHNICAL ENGINEER WILL APPROVE ALL NEW OR NEWLY IMPLEMENTED PROCESSES.

THE CONTRACTOR SHALL EVALUATE ALL MIX DESIGNS BY LABORATORY OR FIELD TRIAL BATCHES. EACH TRIAL BATCH SHALL CONFORM TO THE MATERIALS, PROPORTIONS, AND SLUMP AS PROPOSED BY THE MIX DESIGN. WHEN APPROVED BY THE ENGINEER, TRIAL BATCHES MAY BE PLACED IN THE WORK AT DESIGNATED LOCATIONS WHERE CONCRETE OF LOWER QUALITY IS SPECIFIED. CONCRETE SO PLACED WILL BE CONSIDERED FOR THE PURPOSE OF PAYMENT TO BE THE TYPE OF CONCRETE SPECIFIED AT THAT LOCATION. A MINIMUM OF TEN TEST CYLINDERS SHALL BE MOLDED FROM THE TRIAL BATCH AT THE MAXIMUM WATER CONTENT INDICATED BY THE MIX DESIGN. FIVE OF THE CYLINDERS SHALL BE TESTED AT 7 DAYS SO TO ESTABLISH 7-DAY AVERAGE COMPRESSIVE STRENGTH INFORMATION. THE REMAINING FIVE CYLINDERS SHALL BE TESTED AT NO MORE THAN 28 DAYS AFTER MOLDING AND THE AVERAGE COMPRESSIVE STRENGTH OF THE FIVE CYLINDERS FOR FIELD TEST BATCHES SHALL BE AT LEAST 600 PSI GREATER THAN THE SPECIFIED STRENGTH. FOR LABORATORY PREPARED TEST BATCHES THE COMPRESSIVE STRENGTH OF THE FIVE CYLINDERS SHALL BE 1,000 PSI GREATER THAN THE SPECIFIED STRENGTH. THE MINIMUM STRENGTH OF ANY ONE CYLINDER SHALL NOT BE LESS THAN THE SPECIFIED STRENGTH. CHANGES IN SOURCE OF MATERIALS OR ESTABLISHED PROCEDURES MAY REQUIRE NEW TRIAL BATCHES.

RECLAIMED CONCRETE MATERIAL SHALL NOT BE USED FOR SEA WATER OR SULFATE SOILS CONTACT. MIXTURES ARE NOT NORMALLY RECOMMENDED FOR USE IN PORTLAND CEMENT CONCRETE WHERE ARCHITECTURAL AESTHETICS ARE A CONCERN.

RECLAIMED PLASTIC PORTLAND CEMENT CONCRETE (RPPCC)

A MAXIMUM OF 15 PERCENT BY VOLUME OF RECLAIMED PLASTIC PORTLAND CEMENT CONCRETE CONFORMING TO THIS SECTION MAY BE INCORPORATED INTO FRESH PORTLAND CEMENT CONCRETE. EACH WEIGHMASTER CERTIFICATE SHALL SHOW THE EXACT VOLUME OF RPPCC IN ADDITION TO THE WEIGHMASTER CERTIFICATE REQUIREMENTS OF SECTION 201-1.4.3, "TRANSIT MIXERS".

COUNTY OF ORANGE, OC PUBLIC WORKS DEPARTMENT

Approved

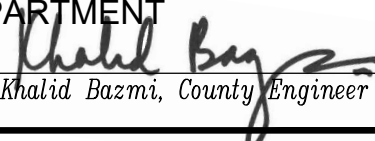
Khalid Bazmi, County Engineer

Revision: August 2018

STD. PLAN

1803

SPECIAL PROVISION - PORTLAND CEMENT CONCRETE

SHT. 8 OF 9

RPPCC MAY BE ANY UN-HARDENED PORTLAND CEMENT CONCRETE PROVIDED ITS DESIGN STRENGTH IS 2,000 PSI OR GREATER, ITS CONSTITUENT MATERIAL CONFORMS TO SECTION 201-1.2, "MATERIALS", AND IT HAS NOT ATTAINED OR HAS BEEN DELAYED FROM ATTAINING INITIAL SET EITHER BY TIME OR BY THE INCORPORATION OF SET-DELAYING CHEMICAL ADMIXTURES. WHEN SET-DELAYING CHEMICAL ADMIXTURES ARE USED, THEY WILL BE USED AT THE MANUFACTURERS RECOMMENDED DOSAGE RATES AND HAVE A PROVEN HISTORY OF SPECIFICALLY MAINTAINING AND EXTENDING BOTH PLASTICITY AND SET. THE CONTRACTOR WILL MAINTAIN PROCESS DOCUMENTATION, MIX DESIGNS, AND SUPPORTIVE CONCRETE TEST DATA AND SHALL PROVIDE THE INFORMATION TO THE ENGINEER UPON REQUEST.

RPPCC WILL BE PROPORTIONED BY VOLUME IN ACCORDANCE WITH SECTION 201-1.3, "PROPORTIONING", RPPCC MAY BE ADDED AT ANY POINT DURING THE PROPORTIONING PROCESS THAT RESULTS IN A CONSISTENT, UNIFORM, AND HOMOGENEOUS FINAL PRODUCT. FOR DESIGN AND PROPORTIONING PURPOSES, ALL RPPCC WILL BE CONSIDERED AS A 2,000 PSI MIXTURE, CONSISTING OF 470 POUNDS OF CEMENTITIOUS MATERIAL. ADDITIONAL PORTLAND CEMENT WILL BE ADDED TO ACHIEVE THE MINIMUM PORTLAND CEMENT CONTENT AND/OR STRENGTH AS REQUIRED FOR A MIXTURE'S CLASS AND USE. THE QUANTITY AND/OR CONSTITUENT MATERIALS OF THE RPPCC SHALL BE MONITORED AND PROPORTIONED SUCH THAT THE FINAL PORTLAND CEMENT CONCRETE GRADATION CONFORMS TO THE REQUIREMENTS OF SECTION 201-1.3.2, "COMBINED AGGREGATE GRADINGS".

RECLAIMED NON-PLASTIC PORTLAND CEMENT CONCRETE MATERIALS

NON-PLASTIC PORTLAND CEMENT CONCRETE MATERIALS SHALL CONSIST OF AN INDIVIDUAL AMOUNT OF OR A COMBINATION OF MATERIALS RESULTING FROM THE RECLAIMING OF PORTLAND CEMENT CONCRETE. BEFORE RECLAMATION, THESE MATERIALS SHALL CONFORM TO SECTION 201-1.2, "MATERIALS". THE RECLAIMED MATERIALS SHALL BE DESIGNATED AS EITHER RECLAIMED AGGREGATES (RA) OR RECLAIMED WATER (RW).

A MAXIMUM OF 30 PERCENT RA BY WEIGHT OF TOTAL AGGREGATE MAY BE INCORPORATED GRADED PORTLAND CEMENT CONCRETE AND/OR RECLAIMED, NATURALLY OCCURRING MINERAL AGGREGATES. RECLAIMED NATURALLY OCCURRING MINERAL AGGREGATES MAY CONTAIN MINOR RESIDUAL AMOUNTS OF PORTLAND CEMENT CONCRETE COMPONENTS AS A RESULT OF RECLAMATION. WHEN CRUSHED PORTLAND CEMENT CONCRETE IS USED AS RA, IT SHALL, WHEN COMBINED WITH NON-RECLAIMED AGGREGATES AT THE PROPOSED PERCENTAGE OF USE CONFORM TO SECTION 201-1.2.2, "AGGREGATES", AND THESE SPECIAL PROVISIONS. WHEN LESS THAN 15 PERCENT RA BY WEIGHT OF TOTAL AGGREGATE IS USED, THE REQUIREMENTS OF SECTION 201-1.2.2, "AGGREGATES", MAY BE WAIVED PROVIDED THE FINAL PORTLAND CEMENT CONCRETE GRADATION CONFORMS TO THE REQUIREMENTS OF SECTION 201-1.3.2, "COMBINED AGGREGATE GRADINGS".

A MAXIMUM OF 35 PERCENT RW BY WEIGHT OF BATCH WATER MAY BE INCORPORATED INTO FRESH PORTLAND CEMENT CONCRETE. RW MAY CONSIST OF NON-DELETERIOUS AMOUNTS OF HYDRATED AND UN-HYDRATED PORTLAND CEMENT, ADMIXTURES, MINOR AMOUNTS OF FLY ASH AND FINE AGGREGATE. THE RECLAMATION PROCESS FOR RW SHALL INCLUDE A MECHANISM TO ENSURE UNIFORMITY AND HOMOGENEITY OF THE RW.

RA AND RW WILL BE PROPORTIONED BY WEIGHT IN ACCORDANCE WITH SECTION 201-1.3, "PROPORTIONING". RA AND RW MAY BE ADDED AT ANY POINT DURING THE PROPORTIONING PROCESS THAT RESULTS IN A CONSISTENT, UNIFORM, AND HOMOGENEOUS FINAL PRODUCT.

COUNTY OF ORANGE, OC PUBLIC WORKS DEPARTMENT

Approved

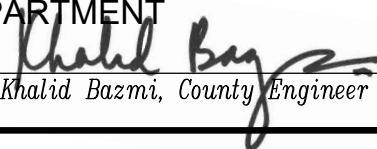
Khalid Bazmi, County Engineer

Revision: August 2018

STD. PLAN

1803

SPECIAL PROVISION - PORTLAND CEMENT CONCRETE

SHT. 9 OF 9

SECTION I. MATERIALS

ASPHALT CONCRETE (AC) SHALL MEET THE REQUIREMENTS OF SECTION 203-6, "ASPHALT CONCRETE", OF THE GREENBOOK AND THESE SPECIAL PROVISIONS. COARSE AGGREGATE SHALL CONSIST OF MATERIAL OF WHICH AT LEAST 75 PERCENT BY WEIGHT SHALL BE CRUSHED PARTICLES IN LIEU OF THE REQUIREMENTS OF SECTION 203-6.2, "MATERIALS".

THE PERFORMANCE GRADE OF PAVING ASPHALT SHALL BE PG 64-10 OR PG 70-10 AS DETERMINED BY THE ENGINEER. COPIES OF TEST REPORTS ON PAVING GRADE ASPHALT, AS DEFINED BY SECTION 203-1.3, "TEST REPORTS AND CERTIFICATION", SHALL BE AVAILABLE FOR EACH SHIPMENT.

PROPOSED ASPHALT CONCRETE JOB MIX FORMULA(S) SHALL BE DETERMINED BY CALIFORNIA TEST METHOD 367, METHOD OF TEST FOR DETERMINING OPTIMUM BITUMEN CONTENT. JOB MIX FORMULAS AND SUPPORTING CALIFORNIA TEST METHOD 367 TEST DATA SHALL BE SUBMITTED TO THE OCPW ENGINEER OR GEOTECHNICAL ENGINEER FOR APPROVAL ANNUALLY IN JANUARY UNLESS OTHERWISE APPROVED BY THE OCPW MATERIALS LABORATORY. IN NO CASE SHALL THE JOB MIX FORMULA, AND ITS SUPPORTING TEST DATA, BE MORE THAN TWO YEARS OLD. THE AGGREGATES USED FOR DETERMINING THE PROPOSED JOB MIX FORMULAS SHALL BE FROM THE SAME SOURCE AS WILL BE USED IN ACTUAL PRODUCTION. CHANGES IN AGGREGATE SOURCE, PAVING ASPHALT SOURCE OR PERFORMANCE GRADE SHALL NOT BE PERMITTED UNLESS A PRE-APPROVED JOB MIX FORMULA FOR THE CHANGED AGGREGATE OR PAVING ASPHALT SOURCE(S) IS ON FILE WITH THE OCPW. SUBMITTALS OF ALL JOB MIX FORMULAS FOR APPROVAL SHALL BE MADE AT LEAST 20 DAYS PRIOR TO INTENDED USE.

AS A GENERAL GUIDELINE THE REQUIRED GRADATION FOR ORANGE COUNTY ASPHALT CONCRETE MIX DESIGNS WILL BE AS FOLLOWS:

ARTERIAL HIGHWAYS

$\frac{1}{2}$ " (III-C2-PG 64-10) SURFACE COURSE
 $\frac{3}{4}$ "(III-B3-PG 64-10) SURFACE COURSE*
 $\frac{3}{4}$ "(III-B2-PG 64-10) BASE COURSE

BIKE TRAIL (OFF ROAD)

$\frac{3}{8}$ "(III-D-PG 64-10) SURFACE COURSE*
 $\frac{1}{2}$ " (III-C3-PG 64-10) BASE AND SURFACE COURSE

NON-ARTERIAL STREETS

$\frac{1}{2}$ " (III-C2-PG 64-10) SURFACE COURSE
 $\frac{3}{4}$ "(III-B3-PG 64-10) BASE COURSE

ASPHALT CONCRETE DIKES

$\frac{3}{8}$ " (III-D-PG 70-10) SURFACE COURSE MIX WITH ONE PERCENT ADDITIONAL BINDER IN A MIX DESIGN APPROVED BY OC PUBLIC WORKS MATERIALS LABORATORY

* USE ONLY WHEN REQUIRED BY THE ENGINEER.

ASPHALT CONCRETE LOAD TICKETS SHALL CLEARLY SHOW THE MIX DESIGNATION FOR THE APPROVED JOB MIX FORMULA

THE GRADATION FOR THE PROJECT ASPHALT CONCRETE JOB MIX FORMULA SHALL BE WITHIN THE SPECIFICATION RANGE AS SET FORTH IN SECTION 203-6, 'ASPHALT CONCRETE', AND TABLE 203-6.5.4(A). DEVIATIONS FROM THE APPROVED PERCENTAGE PASSING EACH APPLICABLE JOB MIX FORMULA SIEVE SIZE SHALL BE LIMITED TO FOLLOWING AND IN NO CASE SHALL THE SUM OF THE ABSOLUTE VALUES OF THE DEVIATIONS EXCEED 15:

COUNTY OF ORANGE, OC PUBLIC WORKS DEPARTMENT

Approved

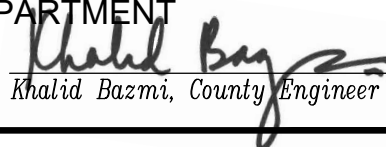
Khalid Bazmi, County Engineer

Revision: August 2018

STD. PLAN

1805

SPECIAL PROVISIONS - ASPHALT CONCRETE

SHT. 1 OF 6

ACCEPTABLE DEVIATION FROM JOB MIX FORMULA

SIEVE	ACCEPTABLE DEVIATION
1"	±3%
¾"	±5%
⅜"	±6%
No. 4	±6%
No. 8	±5%
No. 30	±5%
No. 200	±3%

DELETE THE THIRD SENTENCE OF SECTION 203-6.11. "ACCEPTANCE". AND ADD THE FOLLOWING:
THE ASPHALT BINDER CONTENT SHALL BE WITHIN 0.4 PERCENT ABOVE OR BELOW THE TARGET BINDER RATIO (OPTIMUM BITUMEN CONTENT) IN THE APPROVED MIX DESIGN.

ASPHALT CONCRETE SUPPLIERS SHALL MAINTAIN RECORDS OF EACH AGGREGATE AND ASPHALT PAVING SHIPMENT RECEIVED. PAVING ASPHALT RECORDS SHALL INCLUDE PERFORMANCE GRADE TEST DATA. THESE RECORDS SHALL BE MAINTAINED CURRENT AND BE READILY ACCESSIBLE TO THE ENGINEER AT THE PLANT SITE UPON REQUEST. THE RECORDS SHALL INCLUDE BUT NOT BE LIMITED TO: AGGREGATE OR PAVING ASPHALT SOURCE OF ORIGIN, LOCATION RECEIVED AND THE DATE SHIPPED.

THE SAND EQUIVALENT AND STABILOMETER-VALUE (S-VALUE) REQUIREMENTS OF SECTION 203-6.5, "TYPE III ASPHALT CONCRETE MIXTURES", SHALL BE THE MOVING AVERAGE REQUIREMENTS. INDIVIDUAL TEST REQUIREMENTS FOR SAND EQUIVALENT AND S-VALUE SHALL BE AS DETERMINED BY THE OCPW MATERIALS LABORATORY.

SECTION II. GENERAL PROVISIONS

ADD TO SECTION 302-5.1, "GENERAL", THE FOLLOWING: THE COMBINED AGGREGATE GRADING FOR ASPHALT CONCRETE PLACED ON MISCELLANEOUS AREAS SHALL CONFORM TO THE GRADATION FOR THE ASPHALT CONCRETE PLACED ON THE TRAVELED WAY, UNLESS OTHERWISE DIRECTED BY THE ENGINEER. THE AMOUNT OF ASPHALT BINDER USED IN THE ASPHALT CONCRETE PLACED IN GUTTER, GUTTER FLARES, OVERSIDE DRAINS, AND APRONS AT THE ENDS OF DRAINAGE STRUCTURES, UNLESS OTHERWISE DIRECTED BY THE ENGINEER, SHALL BE INCREASED ONE PERCENT BY WEIGHT OF THE AGGREGATE OVER THE AMOUNT OF ASPHALT BINDER USED IN THE ASPHALT CONCRETE PLACED ON THE TRAVELED WAY.

THE ASPHALT CONCRETE TO BE PLACED IN AREAS WHICH ARE DESIGNATED ON THE PLANS AS MISCELLANEOUS AREAS MAY BE SPREAD IN ONE LAYER. THE MATERIAL SHALL BE COMPACTED TO THE REQUIRED LINES, GRADES AND CROSS-SECTIONS.

DIKES SHALL BE SHAPED AND COMPACTED WITH AN EXTRUSION MACHINE OR OTHER EQUIPMENT CAPABLE OF SHAPING AND COMPACTING THE MATERIAL TO THE REQUIRED CROSS-SECTIONS.

COUNTY OF ORANGE, OC PUBLIC WORKS DEPARTMENT

Approved

Khalid Bazmi, County Engineer

Revision: August 2018

STD. PLAN

1805

SPECIAL PROVISIONS - ASPHALT CONCRETE

SHT. 2 OF 6

IN ADVANCE OF PLACING ASPHALT CONCRETE DIKE ON ASPHALT SURFACING, THE SURFACE SHALL BE BROOMED CLEAN OF ALL LOOSE AND EXTRANEIOUS MATERIAL AND A TACK COAT SHALL BE APPLIED.

IF THE FINISHED SURFACE OF THE ASPHALT CONCRETE ON THE TRAFFIC LANES DOES NOT MEET THE SPECIFIED SURFACE TOLERANCES, IT SHALL BE BROUGHT WITHIN TOLERANCES BY EITHER: (1) ABRASIVE GRINDING AND GROOVING (FOLLOWED BY FOG SEAL ON THE AREAS WHICH HAVE BEEN GROUND), (2) PLACING AN OVERLAY OF ASPHALT CONCRETE, OR (3) REMOVAL AND REPLACEMENT. THE METHOD SHALL BE SELECTED BY THE ENGINEER.

DELETE SECTION 302-5.3, "PRIME COAT", AND SUBSTITUTE THE FOLLOWING: WHEN SPECIFIED OR REQUIRED BY THE PROJECT PLANS, SPECIAL PROVISIONS, OR AS DIRECTED BY THE ENGINEER, A PRIME COAT CONSISTING OF GRADE SC-70 OR SC-250 LIQUID ASPHALT SHALL BE APPLIED TO THE SURFACE OF THE PREPARED BASE OR SUBBASE PRIOR TO PLACING ASPHALT CONCRETE AT THE RATE BETWEEN 0.10 AND 0.25 GALLON PER SQUARE YARD.

MODIFY SECTION 302-5.4, "TACK COAT", AS FOLLOWS: A TACK COAT OF SS-1H TYPE EMULSIFIED ASPHALT, WHERE STIPULATED ON THE PLANS AND SPECIFICATIONS OR REQUIRED BY THE ENGINEER, SHALL BE APPLIED IN ACCORDANCE WITH SECTION 302-5.4, "TACK COAT", MAY BE USED ONLY WHEN APPROVED BY THE ENGINEER. PAVING ASPHALT WHEN, APPROVED, SHALL BE SPREAD IN ACCORDANCE WITH PREVISIONS OF SECTION 203-1, "PAVING ASPHALT".

ADD TO SECTION 302-5.5, "DISTRIBUTION AND SPREADING", THE FOLLOWING: TARPAULINS SHALL BE USED TO COVER ALL LOADS, WHEN DIRECTED BY THE ENGINEER.

UNLESS OTHERWISE PERMITTED BY THE ENGINEER, THE TOP LAYER OF ASPHALT CONCRETE FOR SHOULDERS, TAPERS, TRANSITIONS, ROAD CONNECTIONS, PRIVATE DRIVES, CURVE WIDENINGS, TURNOUTS LEFT TURN POCKETS AND OTHER SUCH AREAS, SHALL NOT BE SPREAD BEFORE THE TOP LAYER OF ASPHALT CONCRETE FOR THE ADJOINING THROUGH LANE HAS BEEN SPREAD AND COMPACTED. AT LOCATIONS WHERE THE NUMBER OF LANES ARE CHANGED, THE TOP LAYER FOR THE THROUGH LANE SHALL BE PAVED FIRST. TRACKS OR WHEELS OF SPREADING EQUIPMENT SHALL NOT BE OPERATED ON THE TOP LAYER OF ASPHALT CONCRETE IN ANY AREA UNTIL FINAL COMPACTION HAS BEEN COMPLETED OR UNLESS DIRECTED BY THE ENGINEER.

UNLESS OTHERWISE SPECIFIED IN THE APPROVED PAVEMENT DESIGN REPORT, THE TOP LAYER OF ASPHALT CONCRETE SHALL NOT EXCEED 0.20-FOOT IN COMPACTED THICKNESS. EACH LANE OF THE TOP LAYER, ONCE COMMENCED, SHALL BE PLACED WITHOUT INTERRUPTION.

UNLESS SPECIFICALLY PROVIDED FOR IN THE SPECIAL PROVISIONS, BOTTOM DUMPS SHALL NOT BE USED IN THE PAVING OPERATION FOR TOP LAYER PAVING OF ASPHALT CONCRETE ON ARTERIAL HIGHWAYS.

ALL SCREED EXTENSIONS FOR PAVING MACHINES SHALL BE PROVIDED WITH A TAMPER, ROLLER OR OTHER SUITABLE COMPACTING DEVICES.

COUNTY OF ORANGE, OC PUBLIC WORKS DEPARTMENT

Approved

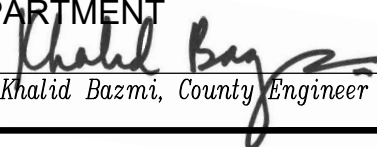
Khalid Bazmi, County Engineer

Revision: August 2018

STD. PLAN

1805

SPECIAL PROVISIONS - ASPHALT CONCRETE

SHT. 3 OF 6

UNLESS OTHERWISE APPROVED BY THE ENGINEER, THE PAVING MACHINES SHALL HAVE A SUITABLE OPERATIONAL JOINT COMPACTING DEVICE IN PLACE AND USE WHEN PLACING THE TOP LAYER OF ASPHALT CONCRETE ON ARTERIAL HIGHWAYS.

ADD TO SECTION 302-5.6, "ROLLING", THE FOLLOWING: THREE-WHEELED ROLLERS AS SPECIFIED IN SECTION 302-5.6.1 "GENERAL", SHALL NOT BE PERMITTED. PNEUMATIC ROLLERS SHALL BE REQUIRED ON LOWER LAYERS ONLY. PNEUMATIC ROLLERS MAY BE USED FOR INTERMEDIATE ROLLING ON FINISH COURSE PAVING FOR ARTERIAL HIGHWAYS WITH THE APPROVAL OF THE ENGINEER.

FOR SUBDIVISION AND PERMIT WORK WITHIN THE COUNTY, THE FINAL OR SURFACE LAYER OF THE ASPHALT CONCRETE SHALL NOT BE PLACED UNTIL ALL ON-SITE IMPROVEMENTS HAVE BEEN COMPLETED, INCLUDING ALL GRADING AND UNTIL ALL UNACCEPTABLE CONCRETE IS REMOVED AND REPLACED AT THE DIRECTION OF THE ENGINEER.

ALL MANHOLE, VALVE AND VAULT COVERS SHALL BE FINISHED ¼ INCH BELOW FINISHED GRADE.

WHEN SPECIFIED OR DIRECTED BY THE ENGINEER, A FOG SEAL OF SS-1H OR CSS-1H TYPE EMULSIFIED ASPHALT SHALL BE APPLIED TO THE FINISHED SURFACE OF ASPHALT CONCRETE PAVEMENT AT A RATE OF 0.05 TO 0.10 GALLON PER SQUARE YARD AS DETERMINED BY THE ENGINEER. ADDITIONAL WATER SHALL BE ADDED TO THE MATERIAL AND MIXED THEREWITH IN SUCH A PROPORTION THAT THE RESULTING MIXTURE WILL CONTAIN NOT MORE THAN 50 PERCENT OF THE ADDED WATER, THE EXACT QUANTITY OF ADDED WATER SHALL BE DETERMINED BY THE ENGINEER. THE RATE OF APPLICATION OF THE RESULTING MIXTURE SHALL BE THAT THE UNDILUTED EMULSION WILL BE SPREAD AT THE SPECIFIED RATE. PRIOR TO PLACEMENT OF THE FOG SEAL, ALL DIRT, MUD, TRASH, OR OTHER LOOSE MATERIAL SHALL BE CLEANED FROM THE AREA TO BE COVERED. ALL ASPHALT CONCRETE PAVING IN LOCAL AND PRIVATE STREETS SHALL REQUIRE A FOG SEAL.

SECTION III. DEEP LIFT PAVING

IN ADDITION TO THE PROVISIONS OF SECTIONS I AND II FOR ASPHALT CONCRETE PAVEMENT, THE FOLLOWING PROVISIONS SHALL BE ADHERED TO WHEN CONSTRUCTING ASPHALT CONCRETE PAVEMENT, DEEP LIFT SECTION, WHERE SHOWN ON THE PLANS OR SPECIFIED BY THE ENGINEER.

ASPHALT CONCRETE BASE SHALL BE SPREAD AT A TEMPERATURE OF NOT LESS THAN 230°F NOR MORE THAN 300°F UNLESS A HIGHER TEMPERATURE IS ORDERED BY THE ENGINEER AND SHALL BE SPREAD AND COMPACTED IN LAYERS NOT TO EXCEED 0.50-FOOT IN COMPACTED THICKNESS. WHEN MORE THAN ONE LAYER OF BASE COURSE IS REQUIRED, THE LAYERS SHALL BE OF EQUAL THICKNESS. THE FOLLOWING SHALL APPLY TO SPREADING:

1. EACH LAYER SHALL BE SPREAD WITH AN APPROVED SPREADING DEVICE WHICH WILL DEPOSIT A UNIFORM LAYER FOR MINIMUM OF ONE TRAFFIC LANE WIDTH. A MOTOR GRADER SHALL NOT BE USED AS THE SPREADING DEVICE.
2. THE MINIMUM TEMPERATURE OF ASPHALT CONCRETE FOR COMPLETION OF THE INITIAL BREAKDOWN COMPACTION SHALL BE 225°F.
3. INITIAL OR BREAKDOWN COMPACTION SHALL BE PERFORMED WITH TWO-OR-THREE-AXLE TANDEM ROLLER WITH A MASS OF NO LESS THAN 12 TONS.

COUNTY OF ORANGE, OC PUBLIC WORKS DEPARTMENT

Approved

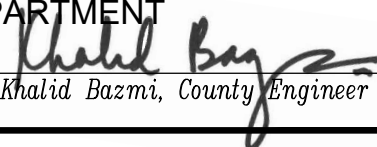
Khalid Bazmi, County Engineer

Revision: August 2018

STD. PLAN

1805

SPECIAL PROVISIONS - ASPHALT CONCRETE

SHT. 4 OF 6

4. FOR COUNTY-FUNDED CONSTRUCTION CONTRACTS, THE INITIAL OR BREAKDOWN ROLLING SHALL BE IMMEDIATELY FOLLOWED BY A MOTOR GRADER WITH ADDITIONAL MATERIAL TO LEVEL IRREGULARITIES AND PROVIDE A UNIFORM SURFACE FOR SUBSEQUENT LAYERS. ADDITIONAL ROLLING SHALL PROCEED DIRECTLY BEHIND THE MOTOR GRADERS WITH A PNEUMATIC-TIRED ROLLER WHILE THE TEMPERATURE OF THE ASPHALT CONCRETE IS ABOVE 180°F.
5. FOR SUBDIVISION AND PERMIT WORK WITHIN THE COUNTY, WHEN THREE OR MORE COURSES ARE REQUIRED, DEPTHS OF THE NEXT COURSE SHALL BE PAINTED FOR THE TOP TWO COURSES AT INTERVALS NOT TO EXCEED 50 FEET AS DIRECTED BY THE ENGINEER.
6. THE SUBSEQUENT LAYERS OF ASPHALT CONCRETE SHALL NOT BE SPREAD WHEN THE UNDERLYING LAYER IS ABOVE 150°F.

SECTION IV. BIKE TRAIL PAVING

THE AMOUNT OF ASPHALT BINDER USED IN THE ASPHALT CONCRETE PLACED FOR OFF ROAD BIKE TRAIL PAVING SHALL BE INCREASED ONE PERCENT BY MASS OF THE AGGREGATE OVER THE AMOUNT OF THE ASPHALT BINDER USED IN THE ASPHALT CONCRETE IF PLACED AS ROADWAY PAVING.

*ASPHALT CONCRETE PAVEMENT FOR THE BIKE TRAIL MAY BE PLACED IN ONE LIFT BY A SELF-PROPELLED MACHINE. ALL OTHER PROVISIONS OF SECTION I AND II SHALL APPLY.

* S-VALUE REQUIREMENTS WILL BE DETERMINED BY THE OCPW ENGINEER OR GEOTECHNICAL ENGINEER.

SECTION V. RUBBERIZED ASPHALT GAP GRADED MIXES

PROPOSED JOB MIX FORMULAS SHALL BE ESTABLISHED BY CALIFORNIA TEST METHOD 367, METHOD OF TEST FOR DETERMINING OPTIMUM BITUMEN CONTENT AS SET FORTH IN SECTION I HEREIN. AGGREGATE GRADATIONS, BINDER AND RUBBER CONTENT SHALL BE AS GENERALLY SET FORTH IN THE GREENBOOK.

SECTION VI. POROUS ASPHALT CONCRETE

POROUS ASPHALT CONCRETE MATERIAL SHALL MEET THE REQUIREMENT OF SECTION 203, "BITUMINOUS MATERIALS", SECTION 302, "ROADWAY SURFACING", AND THESE SPECIAL PROVISIONS.

POROUS ASPHALT CONCRETE SHALL BE THE PRODUCT OF MIXING OPEN-GRADED MINERAL AGGREGATE WITH PAVING ASPHALT AT A CENTRAL MIXING PLANT TO YIELD A NON-STRUCTURAL MATERIAL INTENDED FOR AREAS WHICH CAN BE EFFECTIVELY RESTRICTED FROM HEAVY LOADING AND HIGH TRAFFIC VOLUMES.

SECTION VII. WARM MIX ASPHALT CONCRETE

WARM MIX ASPHALT CONCRETE MATERIAL SHALL MEET THE REQUIREMENTS OF THESE SPECIAL PROVISIONS.

COUNTY OF ORANGE, OC PUBLIC WORKS DEPARTMENT

Approved

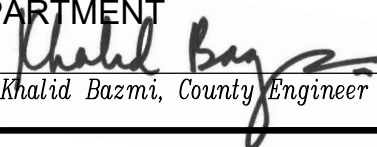
Khalid Bazmi, County Engineer

Revision: August 2018

STD. PLAN

1805

SPECIAL PROVISIONS - ASPHALT CONCRETE

SHT. 5 OF 6

WHEN USING WARM MIX ASPHALT (WMA) TECHNOLOGIES, THE MINIMUM TEMPERATURE OF THE COMPLETE PAVING ASPHALT MIXTURE MAY BE LOWERED TO 121°C (250°F). THE ASPHALT PLANT IS TO BE EQUIPPED WITH THE PROPER EQUIPMENT TO MAKE WARM MIX ASPHALT CONCRETE BY EITHER THE FOAMING, CHEMICAL ADDITIVE, OR ORGANIC ADDITIVE (WAX) METHODS. FOR ALL THE ABOVE WMA METHODS, PAVING ASPHALT CONCRETE MAY BE PRODUCED AT 121°C TO 143°C (250°F TO 290°F) AND THE PRODUCTION TEMPERATURE WILL BE DEPENDENT ON ASPHALT BINDER GRADE. THE TEMPERATURE OF WINDROW WARM MIX ASPHALT SHALL NOT FALL BELOW 118°C (245°F).

IN PLACE COMPACTION OF WARM MIX ASPHALT CONCRETE MAY BE PERFORMED AT TEMPERATURES BELOW THOSE EMPLOYED FOR CONVENTIONAL HOT MIX ASPHALT CONCRETE AND SHOULD BE COMPLETED BEFORE THE IN PLACE WMA TEMPERATURE REACHES 66°C (150°F). WMA SHALL NOT BE PLACED UNLESS THE ATMOSPHERIC TEMPERATURE IS AT LEAST 10°C (50°F) AND RISING OR DURING UNSUITABLE WEATHER.

COUNTY OF ORANGE, OC PUBLIC WORKS DEPARTMENT

Approved

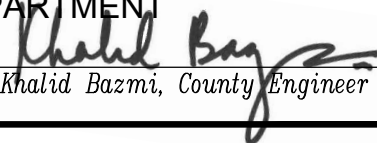
Khalid Bazmi, County Engineer

Revision: August 2018

STD. PLAN

1805

SPECIAL PROVISIONS - ASPHALT CONCRETE

SHT. 6 OF 6

CENTERLINES (2 LANE HIGHWAYS)

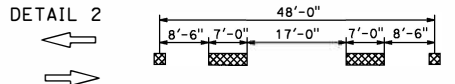
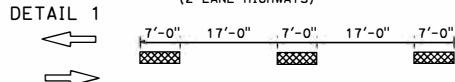

~~DETAIL 3~~ DETAIL 3 DELETED

~~DETAIL 4~~ DETAIL 4 DELETED

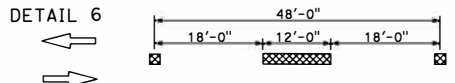
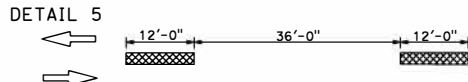

~~DETAIL 7~~ DETAIL 7 DELETED

LANELINES (MULTILANE HIGHWAYS)

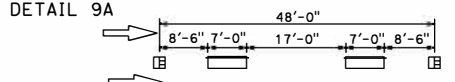
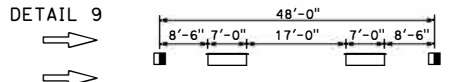
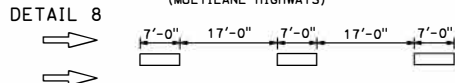

~~DETAIL 10~~ DETAIL 10 DELETED



LANELINES (Cont)

(MULTILANE HIGHWAYS)

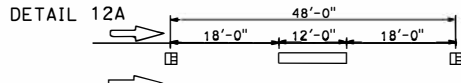
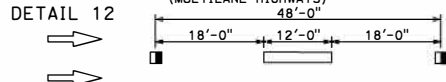

~~DETAIL 13~~ DETAIL 13 DELETED

~~DETAIL 14~~ DETAIL 14 DELETED

~~DETAIL 14A~~ DETAIL 14A DELETED

NO PASSING ZONES-ONE DIRECTION

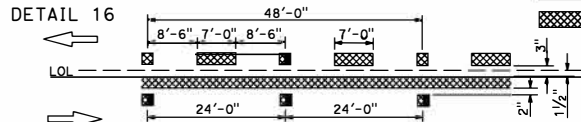
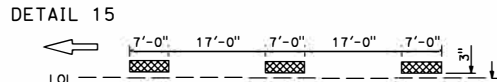

~~DETAIL 17~~ DETAIL 17 DELETED

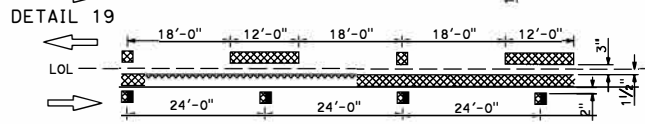
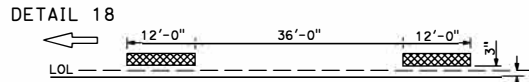

~~DETAIL 20~~ DETAIL 20 DELETED

NO PASSING ZONES-TWO DIRECTION

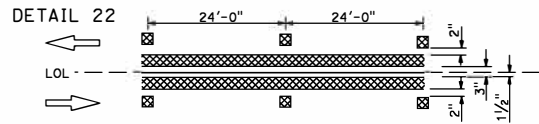

~~DETAIL 23~~ DETAIL 23 DELETED

LEGEND

MARKERS

- TYPE C RED-CLEAR RETROREFLECTIVE
- TYPE D TWO-WAY YELLOW RETROREFLECTIVE
- TYPE G ONE-WAY CLEAR RETROREFLECTIVE
- TYPE H ONE-WAY YELLOW RETROREFLECTIVE

LINES

- 6" WHITE
- 6" YELLOW

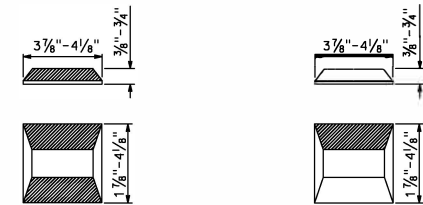

TYPE C AND TYPE D TYPE G AND TYPE H

RETROREFLECTIVE FACE

STATE OF CALIFORNIA
DEPARTMENT OF TRANSPORTATION
**PAVEMENT MARKERS AND TRAFFIC LINES
TYPICAL DETAILS**
NO SCALE

A20A

Dist	COUNTY	ROUTE	POST MILES TOTAL PROJECT	SHEET No.	TOTAL SHEETS

Lee J. Haber
REGISTERED CIVIL ENGINEER

August 1, 2022
PLANS APPROVAL DATE

Lee J. Haber
No. C49132
Exp. 9-30-22
CIVIL
STATE OF CALIFORNIA

THE STATE OF CALIFORNIA OR ITS OFFICERS OR AGENTS SHALL NOT BE RESPONSIBLE FOR THE ACCURACY OR COMPLETENESS OF SCANNED COPIES OF THIS PLAN SHEET.

CHANNELIZING LINE

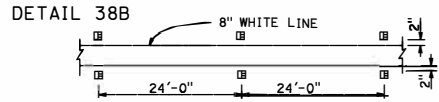
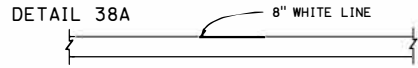
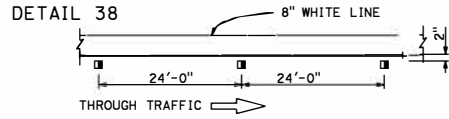

DETAIL 38C DELETED

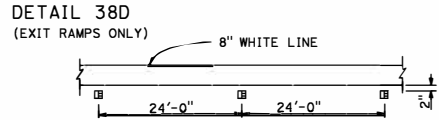

BIKE LANE LINE



INTERSECTION LINE BIKE LANE

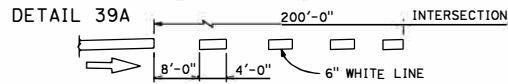

LANE LINE EXTENSIONS THROUGH INTERSECTIONS

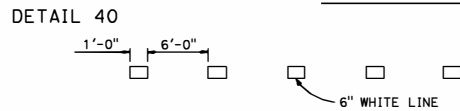

DETAIL 40A DELETED

CENTER LINE EXTENSIONS THROUGH INTERSECTIONS

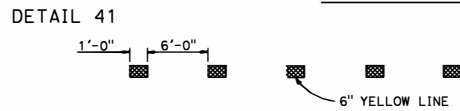

DETAIL 41A DELETED

LEGEND

MARKERS

- TYPE C RED-CLEAR RETROREFLECTIVE
- TYPE G ONE-WAY CLEAR RETROREFLECTIVE
- 6" YELLOW LINE

MARKER DETAILS

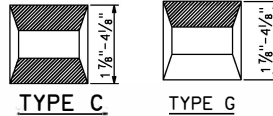
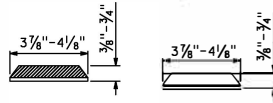

RETROREFLECTIVE FACE

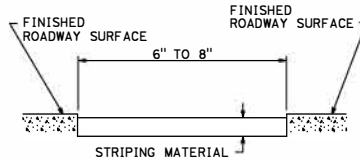

DETAIL FOR RECESSED TRAFFIC STRIPE

See Notes A and B

RECESSED NOTES:

- A. See typical traffic line details for pavement marking patterns.
- B. See standard specifications for recess depth and recess striping material thickness.

DIST.	COUNTY	ROUTE	POST MILES TOTAL PROJECT	SHEET NO.	TOTAL SHEETS

Lee J. Haber
REGISTERED CIVIL ENGINEER

August 1, 2022
PLANS APPROVAL DATE

Lee J. Haber
No. C49132
Exp. 9-30-22
CIVIL
STATE OF CALIFORNIA

THE STATE OF CALIFORNIA OR ITS OFFICERS OR AGENTS SHALL NOT BE RESPONSIBLE FOR THE ACCURACY OR COMPLETENESS OF SCANNED COPIES OF THIS PLAN SHEET.

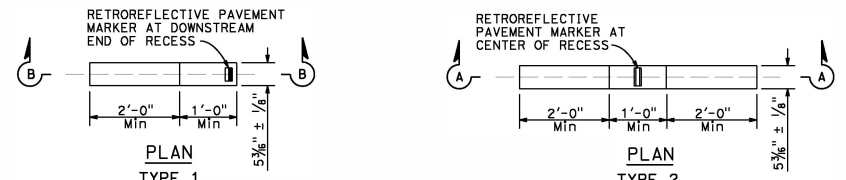
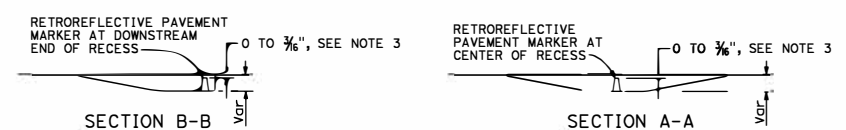

RECESS DETAIL FOR RETROREFLECTIVE PAVEMENT MARKER

See Note 4

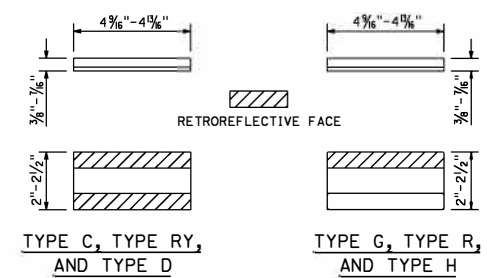

RECESSED MARKER NOTES:

1. See typical traffic line details for marker patterns to be used with recessed pavement markers.
2. The retroreflective pavement markers shown for recessed installations are not to be used for non-recessed installations.
3. The top of pavement markers installed in recesses shall be 0 to 3/16" below the pavement surface.
4. Use Type 1 recess for pavement markers with one-way retroreflective face. Use Type 2 recess for pavement markers with two-way retroreflective face.

RETROREFLECTIVE PAVEMENT MARKER FOR RECESSED INSTALLATION

See Notes 1 and 2

PAVEMENT MARKERS AND TRAFFIC LINES TYPICAL DETAILS

NO SCALE

A20D

2022 STANDARD PLAN A20D

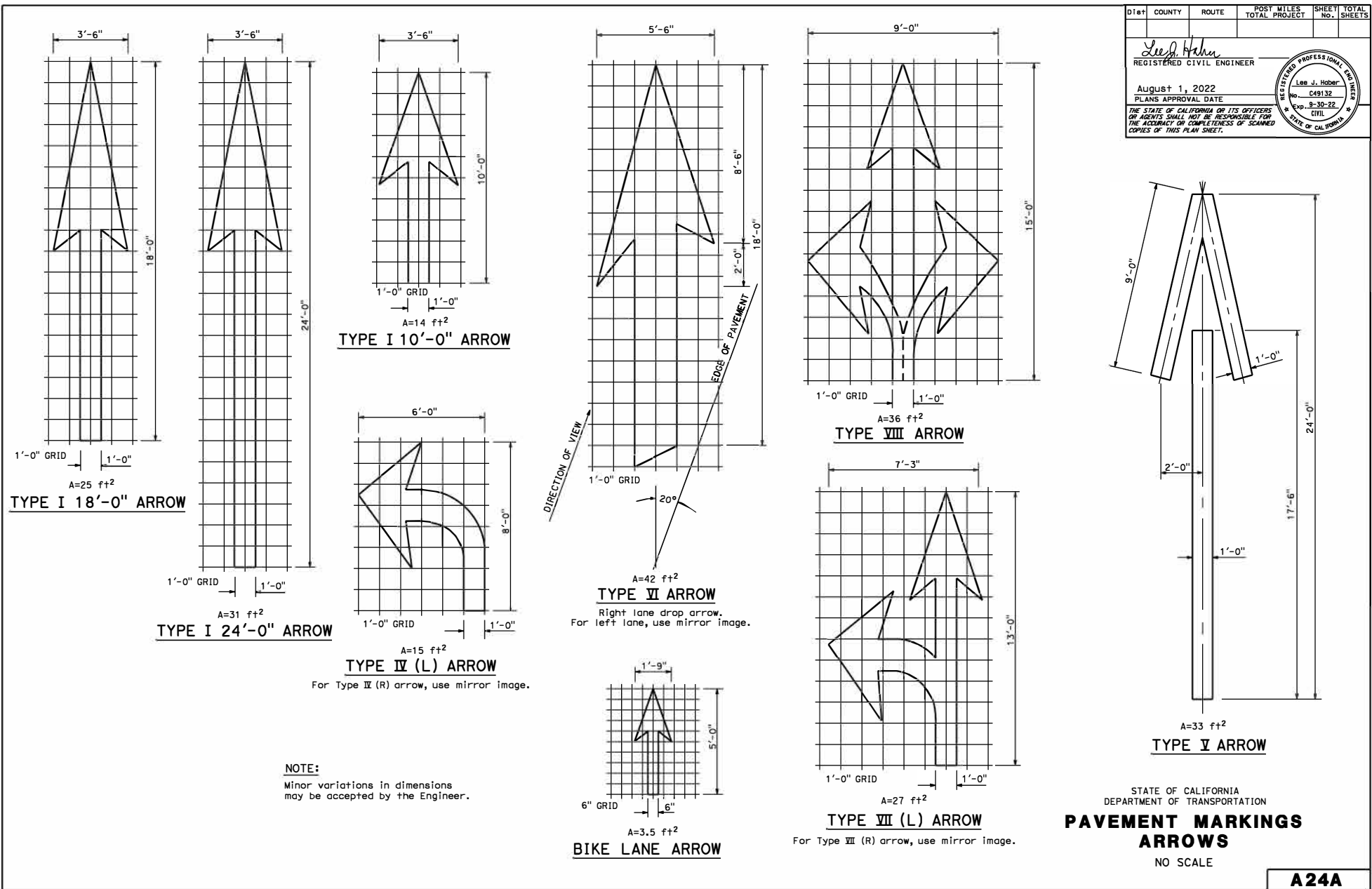

DIST	COUNTY	ROUTE	POST MILES TOTAL PROJECT	SHEET NO.	TOTAL SHEETS

Lee J. Hober
 REGISTERED CIVIL ENGINEER

August 1, 2022
 PLANS APPROVAL DATE

Lee J. Hober
 No. C49132
 Exp. 9-30-22
 CIVIL
 STATE OF CALIFORNIA

THE STATE OF CALIFORNIA OR ITS OFFICERS OR AGENTS SHALL NOT BE RESPONSIBLE FOR THE ACCURACY OR COMPLETENESS OF SCANNED COPIES OF THIS PLAN SHEET.

2022 STANDARD PLAN A24A

STATE OF CALIFORNIA
 DEPARTMENT OF TRANSPORTATION
**PAVEMENT MARKINGS
 ARROWS**
 NO SCALE

A24A

[Return to Table of Contents](#)

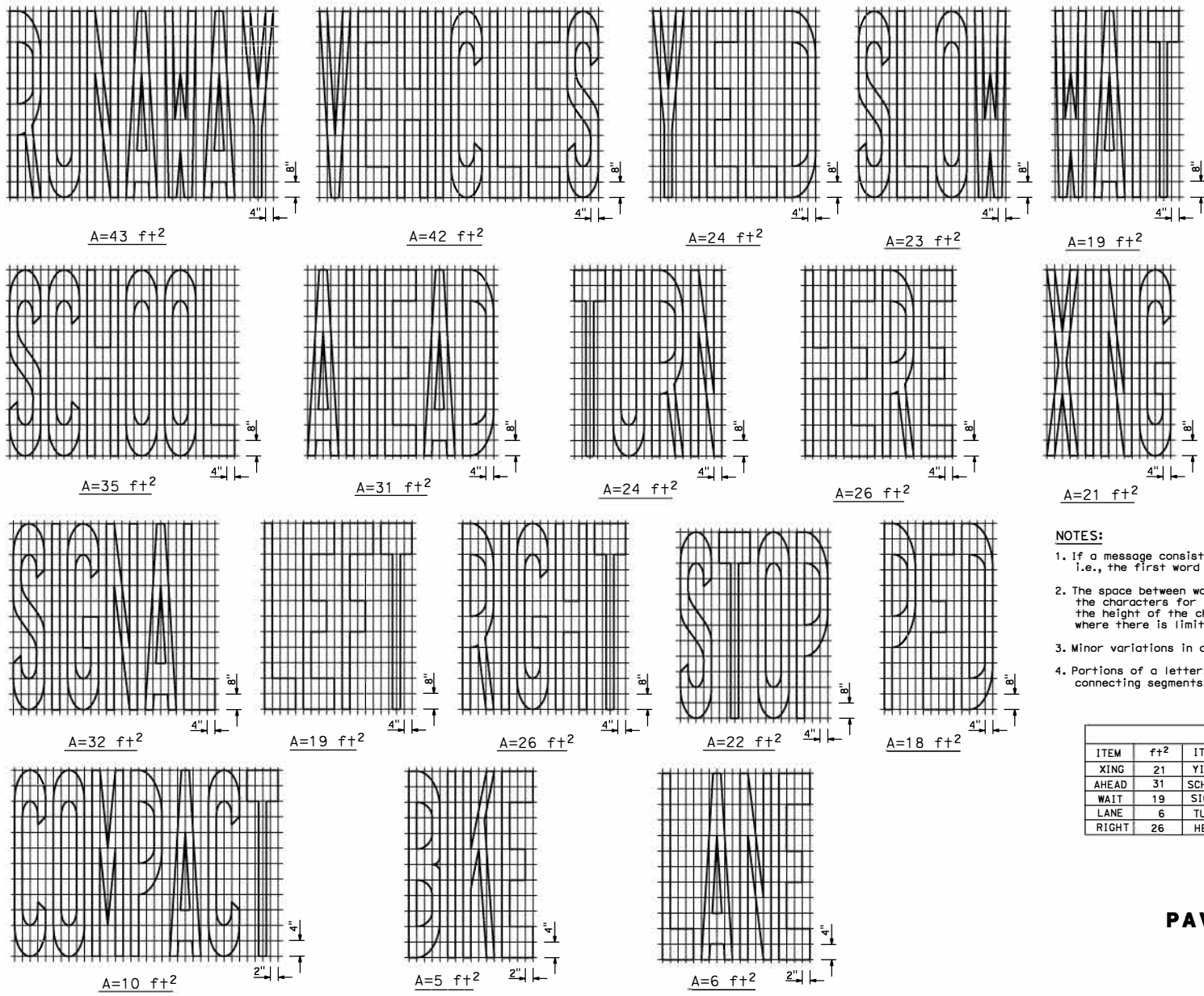

DIST	COUNTY	ROUTE	POST MILES TOTAL PROJECT	SHEET TOTAL SHEETS

Lee J. Haber
 REGISTERED CIVIL ENGINEER

August 1, 2022
 PLANS APPROVAL DATE

THE STATE OF CALIFORNIA OR ITS OFFICERS OR AGENTS SHALL NOT BE RESPONSIBLE FOR THE ACCURACY OR COMPLETENESS OF SCANNED COPIES OF THIS PLAN SHEET.

Lee J. Haber
 No. C09132
 Exp. 8-30-22
 CIVIL
 STATE OF CALIFORNIA

- NOTES:**
1. If a message consists of more than one word, it must read "UP", i.e., the first word must be nearest the driver.
 2. The space between words must be at least four times the height of the characters for low speed roads, but not more than ten times the height of the characters. The space may be reduced appropriately where there is limited space because of local conditions.
 3. Minor variations in dimensions may be accepted by the Engineer.
 4. Portions of a letter, number or symbol may be separated by connecting segments not to exceed 2" in width.

WORD MARKINGS							
ITEM	f+2	ITEM	f+2	ITEM	f+2	ITEM	f+2
XING	21	YIELD	24	BIKE	5	PED	18
AHEAD	31	SCHOOL	35	SLOW	23	COMPACT	10
WAIT	19	SIGNAL	32	STOP	22	RUNAWAY	43
LANE	6	TURN	24	LEFT	19	VEHICLES	42
RIGHT	26	HERE	26				

STATE OF CALIFORNIA
 DEPARTMENT OF TRANSPORTATION
PAVEMENT MARKINGS WORDS
 NO SCALE

A 24D

2022 STANDARD PLAN A24D

[Return to Table of Contents](#)

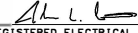
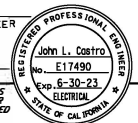
DIST	COUNTY	ROUTE	POST MILES TOTAL PROJECT	SHEET NO.	TOTAL SHEETS
 REGISTERED ELECTRICAL ENGINEER August 1, 2022 PLANS APPROVAL DATE No. E17490 Exp. 6-30-23 THE STATE OF CALIFORNIA OR ITS OFFICERS OR AGENTS SHALL NOT BE RESPONSIBLE FOR THE ACCURACY OR COMPLETENESS OF SCANNED COPIES OF THIS PLAN SHEET.					
					

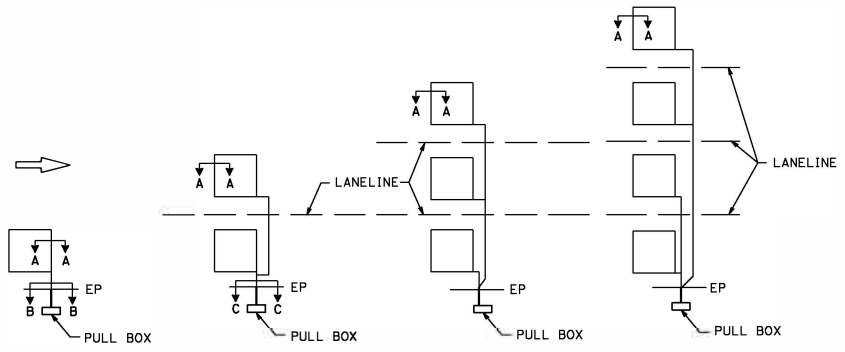

SAW CUT DETAILS
Type A loop detector configurations illustrated

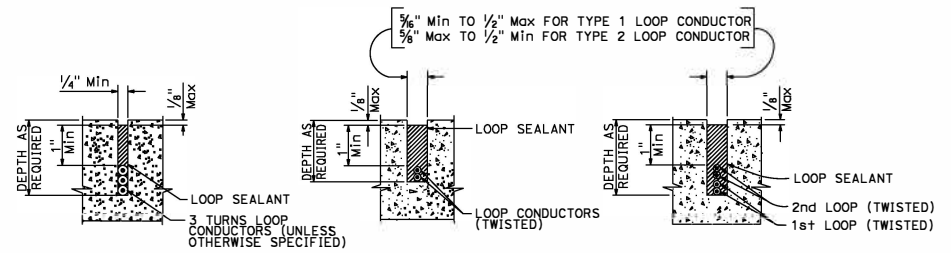

SLOT DETAILS - TYPE 1 AND TYPE 2 LOOP CONDUCTOR

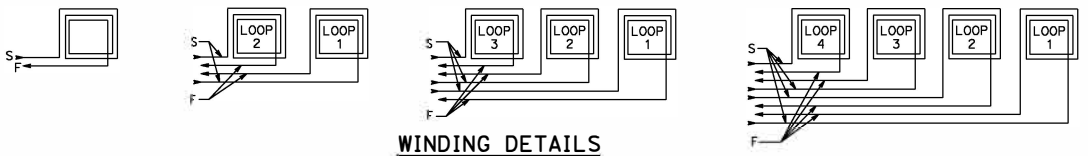

WINDING DETAILS

ABBREVIATIONS:
S - START
F - FINISH

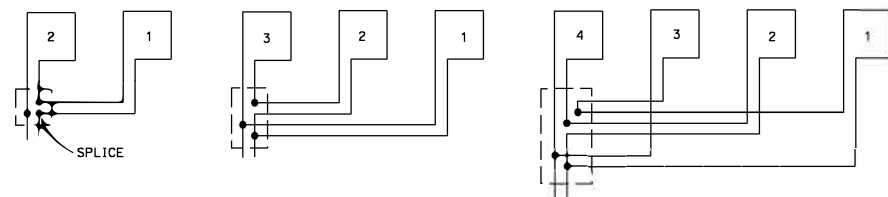

TYPICAL LOOP CONNECTIONS
Dashed lines represent the pull box

STATE OF CALIFORNIA
DEPARTMENT OF TRANSPORTATION
**ELECTRICAL SYSTEMS
(LOOP DETECTORS)**

NO SCALE

ES-5A

533

2022 STANDARD PLAN ES-5A

[Return to Table of Contents](#)

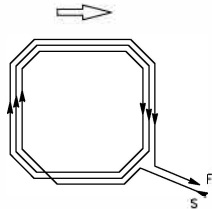

WINDING DETAIL
TYPE A LOOP DETECTOR CONFIGURATION

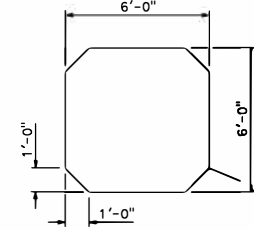

SAW CUT DETAIL

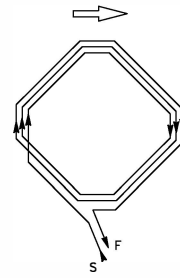

WINDING DETAIL
TYPE B LOOP DETECTOR CONFIGURATION

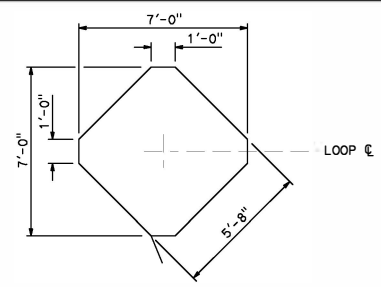

SAW CUT DETAIL

DIST	COUNTY	ROUTE	POST MILES TOTAL PROJECT	SHEET NO.	TOTAL SHEETS

REGISTERED ELECTRICAL ENGINEER
 August 1, 2022
 PLANS APPROVAL DATE
 THE STATE OF CALIFORNIA OR ITS OFFICERS OR AGENTS SHALL NOT BE RESPONSIBLE FOR THE ACCURACY OR COMPLETENESS OF SCANNED COPIES OF THIS PLAN SHEET.

- NOTES:**
1. Round corners of acute angle saw cuts to prevent damage to conductors.
 2. Typical distance separating loops from edge to edge is 10' for Type A, B, D, E, and F installation in single lane.
 3. Use Type D and F loops for limit line detection and bicycle lanes.

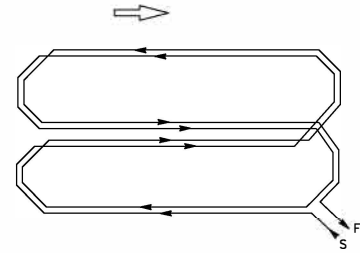

WINDING DETAIL
TYPE C LOOP DETECTOR CONFIGURATION

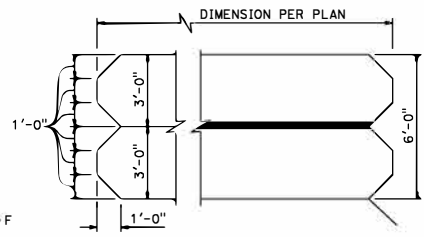

SAW CUT DETAIL

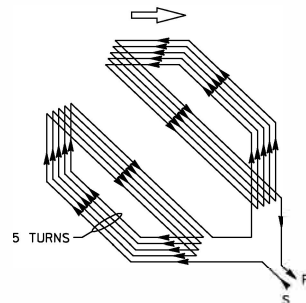

WINDING DETAIL
TYPE D LOOP DETECTOR CONFIGURATION

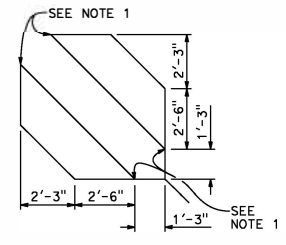

SAW CUT DETAIL

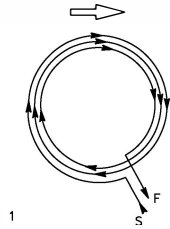

WINDING DETAIL
TYPE E LOOP DETECTOR CONFIGURATION

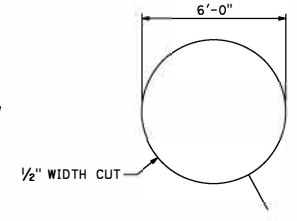

SAW CUT DETAIL

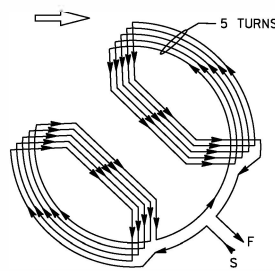

WINDING DETAIL
TYPE F LOOP DETECTOR CONFIGURATION

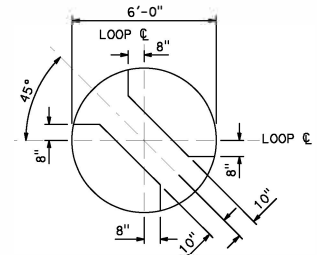

SAW CUT DETAIL

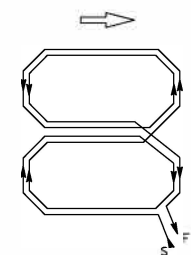

WINDING DETAIL
TYPE Q LOOP DETECTOR CONFIGURATION

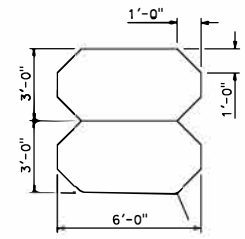

SAW CUT DETAIL

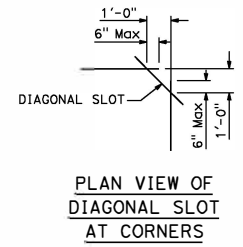

PLAN VIEW OF
DIAGONAL SLOT
AT CORNERS

STATE OF CALIFORNIA
DEPARTMENT OF TRANSPORTATION
ELECTRICAL SYSTEMS
(DETECTORS)
NO SCALE

APPENDIX B

FEDERAL MINIMUM WAGE REQUIREMENTS

Prevailing Wage Rates are no longer provided by the Department of Industrial Relations as a comprehensive, singular, downloadable PDF file from their website.

Instead, contractors are instructed to review the applicable Prevailing Wage Rates at:

<https://www.dir.ca.gov/Public-Works/Prevailing-Wage.html>

Contractors shall pay applicable prevailing wage rates to workers on this project.

APPENDIX C

EXCERPTS FROM STATE LABOR CODE

[Home](#)
[Bill Information](#)
[California Law](#)
[Publications](#)
[Other Resources](#)
[My Subscriptions](#)
[My Favorites](#)
Code:
Section:



[Up^](#) [Add To My Favorites](#)

LABOR CODE - LAB

DIVISION 2. EMPLOYMENT REGULATION AND SUPERVISION [200 - 2699.8] (*Division 2 enacted by Stats. 1937, Ch. 90.*)

PART 7. PUBLIC WORKS AND PUBLIC AGENCIES [1720 - 1964] (*Part 7 enacted by Stats. 1937, Ch. 90.*)

CHAPTER 1. Public Works [1720 - 1861] (*Chapter 1 enacted by Stats. 1937, Ch. 90.*)

ARTICLE 2. Wages [1770 - 1785] (*Article 2 enacted by Stats. 1937, Ch. 90.*)

1770. The Director of the Department of Industrial Relations shall determine the general prevailing rate of per diem wages in accordance with the standards set forth in Section 1773, and the director's determination in the matter shall be final except as provided in Section 1773.4. Nothing in this article, however, shall prohibit the payment of more than the general prevailing rate of wages to any worker employed on public work. This chapter does not permit any overtime work in violation of Article 3.

(Amended by Stats. 2017, Ch. 28, Sec. 17. (SB 96) Effective June 27, 2017.)

1771. Except for public works projects of one thousand dollars (\$1,000) or less, not less than the general prevailing rate of per diem wages for work of a similar character in the locality in which the public work is performed, and not less than the general prevailing rate of per diem wages for holiday and overtime work fixed as provided in this chapter, shall be paid to all workers employed on public works.

This section is applicable only to work performed under contract, and is not applicable to work carried out by a public agency with its own forces. This section is applicable to contracts let for maintenance work.

(Amended by Stats. 1981, Ch. 449, Sec. 1.)

1771.1. (a) A contractor or subcontractor shall not be qualified to bid on, be listed in a bid proposal, subject to the requirements of Section 4104 of the Public Contract Code, or engage in the performance of any contract for public work, as defined in this chapter, unless currently registered and qualified to perform public work pursuant to Section 1725.5. It is not a violation of this section for an unregistered contractor to submit a bid that is authorized by Section 7029.1 of the Business and Professions Code or by Section 10164 or 20103.5 of the Public Contract Code, provided the contractor is registered to perform public work pursuant to Section 1725.5 at the time the contract is awarded.

(b) Notice of the requirement described in subdivision (a) shall be included in all bid invitations and public works contracts, and a bid shall not be accepted nor any contract or subcontract entered into without proof of the contractor or subcontractor's current registration to perform public work pursuant to Section 1725.5.

(c) An inadvertent error in listing a subcontractor who is not registered pursuant to Section 1725.5 in a bid proposal shall not be grounds for filing a bid protest or grounds for considering the bid nonresponsive, provided that any of the following apply:

(1) The subcontractor is registered prior to the bid opening.

(2) Within 24 hours after the bid opening, the subcontractor is registered and has paid the penalty registration fee specified in subparagraph (E) of paragraph (2) of subdivision (a) of Section 1725.5.

(3) The subcontractor is replaced by another registered subcontractor pursuant to Section 4107 of the Public Contract Code.

(d) Failure by a subcontractor to be registered to perform public work as required by subdivision (a) shall be grounds under Section 4107 of the Public Contract Code for the contractor, with the consent of the awarding authority, to substitute a subcontractor who is registered to perform public work pursuant to Section 1725.5 in place of the unregistered subcontractor.

(e) The department shall maintain on its Internet Web site a list of contractors who are currently registered to perform public work pursuant to Section 1725.5.

(f) A contract entered into with any contractor or subcontractor in violation of subdivision (a) shall be subject to cancellation, provided that a contract for public work shall not be unlawful, void, or voidable solely due to the failure of the awarding body, contractor, or any subcontractor to comply with the requirements of Section 1725.5 or this section.

(g) If the Labor Commissioner or his or her designee determines that a contractor or subcontractor engaged in the performance of any public work contract without having been registered in accordance with this section, the contractor or subcontractor shall forfeit, as a civil penalty to the state, one hundred dollars (\$100) for each day of work performed in violation of the registration requirement, not to exceed an aggregate penalty of eight thousand dollars (\$8,000) in addition to any penalty registration fee assessed pursuant to clause (ii) of subparagraph (E) of paragraph (2) of subdivision (a) of Section 1725.5.

(h) (1) In addition to, or in lieu of, any other penalty or sanction authorized pursuant to this chapter, a higher tiered public works contractor or subcontractor who is found to have entered into a subcontract with an unregistered lower tier subcontractor to perform any public work in violation of the requirements of Section 1725.5 or this section shall be subject to forfeiture, as a civil penalty to the state, of one hundred dollars (\$100) for each day the unregistered lower tier subcontractor performs work in violation of the registration requirement, not to exceed an aggregate penalty of ten thousand dollars (\$10,000).

(2) The Labor Commissioner shall use the same standards specified in subparagraph (A) of paragraph (2) of subdivision (a) of Section 1775 when determining the severity of the violation and what penalty to assess, and may waive the penalty for a first time violation that was unintentional and did not hinder the Labor Commissioner's ability to monitor and enforce compliance with the requirements of this chapter.

(3) A higher tiered public works contractor or subcontractor shall not be liable for penalties assessed pursuant to paragraph (1) if the lower tier subcontractor's performance is in violation of the requirements of Section 1725.5 due to the revocation of a previously approved registration.

(4) A subcontractor shall not be liable for any penalties assessed against a higher tiered public works contractor or subcontractor pursuant to paragraph (1). A higher tiered public works contractor or subcontractor may not require a lower tiered subcontractor to indemnify or otherwise be liable for any penalties pursuant to paragraph (1).

(i) The Labor Commissioner or his or her designee shall issue a civil wage and penalty assessment, in accordance with the provisions of Section 1741, upon determination of penalties pursuant to subdivision (g) and subparagraph (B) of paragraph (1) of subdivision (h). Review of a civil wage and penalty assessment issued under this subdivision may be requested in accordance with the provisions of Section 1742. The regulations of the Director of Industrial Relations, which govern proceedings for review of civil wage and penalty assessments and the withholding of contract payments under Article 1 (commencing with Section 1720) and Article 2 (commencing with Section 1770), shall apply.

(j) (1) Where a contractor or subcontractor engages in the performance of any public work contract without having been registered in violation of the requirements of Section 1725.5 or this section, the Labor Commissioner shall issue and serve a stop order prohibiting the use of the unregistered contractor or the unregistered subcontractor on all public works until the unregistered contractor or unregistered subcontractor is registered. The stop order shall not apply to work by registered contractors or subcontractors on the public work.

(2) A stop order may be personally served upon the contractor or subcontractor by either of the following methods:

(A) Manual delivery of the order to the contractor or subcontractor personally.

(B) Leaving signed copies of the order with the person who is apparently in charge at the site of the public work and by thereafter mailing copies of the order by first class mail, postage prepaid to the contractor or subcontractor at one of the following:

(i) The address of the contractor or subcontractor on file with either the Secretary of State or the Contractors' State License Board.

(ii) If the contractor or subcontractor has no address on file with the Secretary of State or the Contractors' State License Board, the address of the site of the public work.

(3) The stop order shall be effective immediately upon service and shall be subject to appeal by the party contracting with the unregistered contractor or subcontractor, by the unregistered contractor or subcontractor, or both. The appeal, hearing, and any further review of the hearing decision shall be governed by the procedures, time limits, and other requirements specified in subdivision (a) of Section 238.1.

(4) Any employee of an unregistered contractor or subcontractor who is affected by a work stoppage ordered by the commissioner pursuant to this subdivision shall be paid at his or her regular hourly prevailing wage rate by that employer for any hours the employee would have worked but for the work stoppage, not to exceed 10 days.

(k) Failure of a contractor or subcontractor, owner, director, officer, or managing agent of the contractor or subcontractor to observe a stop order issued and served upon him or her pursuant to subdivision (j) is guilty of a misdemeanor punishable by imprisonment in county jail not exceeding 60 days or by a fine not exceeding ten thousand dollars (\$10,000), or both.

(l) This section shall apply to any bid proposal submitted on or after March 1, 2015, and any contract for public work entered into on or after April 1, 2015. This section shall also apply to the performance of any public work, as defined in this chapter, on or after January 1, 2018, regardless of when the contract for public work was entered.

(m) Penalties received pursuant to this section shall be deposited in the State Public Works Enforcement Fund established by Section 1771.3 and shall be used only for the purposes specified in that section.

(n) This section shall not apply to work performed on a public works project of twenty-five thousand dollars (\$25,000) or less when the project is for construction, alteration, demolition, installation, or repair work or to work performed on a public works project of fifteen thousand dollars (\$15,000) or less when the project is for maintenance work.

(Amended by Stats. 2018, Ch. 455, Sec. 2. (SB 877) Effective September 17, 2018.)

1771.2. (a) A joint labor-management committee established pursuant to the federal Labor Management Cooperation Act of 1978 (29 U.S.C. Sec. 175a) may bring an action in any court of competent jurisdiction against an employer that fails to pay the prevailing wage to its employees, as required by this article, or that fails to provide payroll records as required by Section 1776. This action shall be commenced not later than 18 months after the filing of a valid notice of completion in the office of the county recorder in each county in which the public work or some part thereof was performed, or not later than 18 months after acceptance of the public work, whichever occurs last.

(b) (1) In an action brought pursuant to this section, the court shall award restitution to an employee for unpaid wages, plus interest, under Section 3289 of the Civil Code from the date that the wages became due and payable, and liquidated damages equal to the amount of unpaid wages owed, and may impose civil penalties, only against an employer that failed to pay the prevailing wage to its employees, in accordance with Section 1775, injunctive relief, or any other appropriate form of equitable relief. The court shall follow the same standards and have the same discretion in setting the amount of penalties as are provided by subdivision (a) of Section 1775. The court shall award a prevailing joint labor-management committee its reasonable attorney's fees and costs incurred in maintaining the action, including expert witness fees.

(2) An action pursuant to this section shall not be based on the employer's misclassification of the craft of a worker in its certified payroll records.

(3) Liquidated damages shall be awarded only if the complaint alleges with specificity the wages due and unpaid to the individual workers, including how that amount was calculated, and the defendant fails to pay the wages, deposit that amount with the court to be held in escrow, or provide proof to the court of an adequate surety bond to cover the wages, within 60 days of service of the complaint. Liquidated damages shall be awarded only on the wages found to be due and unpaid. Additionally, if the defendant demonstrates to the satisfaction of the court that the defendant had substantial grounds for contesting that a portion of the allegedly unpaid wages were owed, the court may exercise its discretion to waive the payment of the liquidated damages with respect to that portion of the unpaid wages.

(4) This subdivision does not limit any other available remedies for a violation of this chapter.

(Amended by Stats. 2018, Ch. 682, Sec. 1. (AB 3231) Effective January 1, 2019.)

1771.3. (a) The State Public Works Enforcement Fund is hereby created as a special fund in the State Treasury to be available upon appropriation of the Legislature. All registration fees collected pursuant to Section 1725.5 and any other moneys as are designated by statute or order shall be deposited in the fund for the purposes specified in subdivision (b).

(b) Moneys in the State Public Works Enforcement Fund shall be used only for the following purposes:

- (1) The reasonable costs of administering the registration of contractors and subcontractors to perform public work pursuant to Section 1725.5.
- (2) The costs and obligations associated with the administration and enforcement of the requirements of this chapter by the Department of Industrial Relations.
- (3) The monitoring and enforcement of any requirement of this code by the Labor Commissioner on a public works project or in connection with the performance of public work as defined pursuant to this chapter.

(c) The annual contractor registration renewal fee specified in subdivision (a) of Section 1725.5, and any adjusted application or renewal fee, shall be set in amounts that are sufficient to support the annual appropriation approved by the Legislature for the State Public Works Enforcement Fund and not result in a fund balance greater than 25 percent of the appropriation. Any year-end balance in the fund greater than 25 percent of the appropriation shall be applied as a credit when determining any fee adjustments for the subsequent fiscal year.

(d) To provide adequate cashflow for the purposes specified in subdivision (b), the Director of Finance, with the concurrence of the Secretary of the Labor and Workforce Development Agency, may approve a short-term loan each fiscal year from the Labor Enforcement and Compliance Fund to the State Public Works Enforcement Fund.

- (1) The maximum amount of the annual loan allowable may be up to, but shall not exceed 50 percent of the appropriation authority of the State Public Works Enforcement Fund in the same year in which the loan was made.
- (2) For the purposes of this section, a "short-term loan" is a transfer that is made subject to both of the following conditions:
 - (A) Any amount loaned is to be repaid in full during the same fiscal year in which the loan was made, except that repayment may be delayed until a date not more than 30 days after the date of enactment of the annual Budget Act for the subsequent fiscal year.
 - (B) Loans shall be repaid whenever the funds are needed to meet cash expenditure needs in the loaning fund or account.

(Amended by Stats. 2017, Ch. 28, Sec. 19. (SB 96) Effective June 27, 2017.)

1771.4. (a) All of the following are applicable to all public works projects that are otherwise subject to the requirements of this chapter:

- (1) The call for bids and contract documents shall specify that the project is subject to compliance monitoring and enforcement by the Department of Industrial Relations.
- (2) The awarding body shall post or require the prime contractor to post job site notices, as prescribed by regulation.
- (3) (A) Each contractor and subcontractor shall furnish the records specified in Section 1776 directly to the Labor Commissioner, in the following manner:
 - (i) At least monthly or more frequently if specified in the contract with the awarding body. For purposes of this clause, "monthly" means that a submission of records shall be made at least once every 30 days while work is being performed on the project and within 30 days after the final day of work performed on the project.
 - (ii) In an electronic format, in the manner prescribed by the Labor Commissioner, on the department's internet website.
- (B) A contractor or subcontractor who fails to furnish records pursuant to subparagraph (A), relating to its employees, shall be subject to a penalty by the Labor Commissioner of one hundred dollars (\$100) per each day in which that party was in violation of subparagraph (A), not to exceed a total penalty of five thousand dollars (\$5,000) per project. Penalties received pursuant to this paragraph shall be deposited in the State Public Works Enforcement Fund established by Section 1771.3 and shall be used only for the purposes specified in that section.
- (C) The Labor Commissioner shall not levy a penalty pursuant to subparagraph (B) until a contractor or subcontractor fails to furnish the records pursuant to subparagraph (A) 14 days after the requirement set forth

in clause (i) of subparagraph (A).

(D) Penalties pursuant to subparagraph (B) may only accrue to the actual contractor or subcontractor that failed to furnish the records pursuant to subparagraph (A).

(4) If the contractor or subcontractor is not registered pursuant to Section 1725.5 and is performing work on a project for which registration is not required because of subdivision (f) of Section 1725.5, the unregistered contractor or subcontractor is not required to furnish the records specified in Section 1776 directly to the Labor Commissioner but shall retain the records specified in Section 1776 for at least three years after completion of the work.

(5) The department shall undertake those activities it deems necessary to monitor and enforce compliance with prevailing wage requirements.

(b) The Labor Commissioner may exempt a public works project from compliance with all or part of the requirements of subdivision (a) if either of the following occurs:

(1) The awarding body has enforced an approved labor compliance program, as defined in Section 1771.5, on all public works projects under its authority, except those deemed exempt pursuant to subdivision (a) of Section 1771.5, continuously since December 31, 2011.

(2) The awarding body has entered into a collective bargaining agreement that binds all contractors performing work on the project and that includes a mechanism for resolving disputes about the payment of wages.

(c) The requirements of paragraph (1) of subdivision (a) shall only apply to contracts for public works projects awarded on or after January 1, 2015.

(d) The requirements of paragraph (3) of subdivision (a) shall apply to all contracts for public work, whether new or ongoing, on or after January 1, 2016.

(Amended by Stats. 2021, Ch. 326, Sec. 1. (AB 1023) Effective January 1, 2022.)

1771.5. (a) Notwithstanding Section 1771, an awarding body may choose not to require the payment of the general prevailing rate of per diem wages or the general prevailing rate of per diem wages for holiday and overtime work for any public works project of twenty-five thousand dollars (\$25,000) or less when the project is for construction work, or for any public works project of fifteen thousand dollars (\$15,000) or less when the project is for alteration, demolition, repair, or maintenance work, if the awarding body has elected to initiate and has been approved by the Director of Industrial Relations to enforce a labor compliance program pursuant to subdivision (b) for every public works project under the authority of the awarding body.

(b) For purposes of this section, a labor compliance program shall include, but not be limited to, the following requirements:

(1) All bid invitations and public works contracts shall contain appropriate language concerning the requirements of this chapter.

(2) A prejob conference shall be conducted with the contractor and subcontractors to discuss federal and state labor law requirements applicable to the contract.

(3) Project contractors and subcontractors shall maintain and furnish, at a designated time, a certified copy of each weekly payroll containing a statement of compliance signed under penalty of perjury.

(4) The awarding body shall review, and, if appropriate, audit payroll records to verify compliance with this chapter.

(5) The awarding body shall withhold contract payments when payroll records are delinquent or inadequate.

(6) The awarding body shall withhold contract payments equal to the amount of underpayment and applicable penalties when, after investigation, it is established that underpayment has occurred.

(7) The awarding body shall comply with any other prevailing wage monitoring and enforcement activities that are required to be conducted by labor compliance programs by the Department of Industrial Relations.

(c) For purposes of this chapter, "labor compliance program" means a labor compliance program that is approved, as specified in state regulations, by the Director of Industrial Relations.

(d) For purposes of this chapter, the Director of Industrial Relations may revoke the approval of a labor compliance program in the manner specified in state regulations.

(Amended by Stats. 2014, Ch. 28, Sec. 67. (SB 854) Effective June 20, 2014.)

1771.6. (a) Any awarding body that enforces this chapter in accordance with Section 1726 or 1771.5 shall provide notice of the withholding of contract payments to the contractor and subcontractor, if applicable. The notice shall be in writing and shall describe the nature of the violation and the amount of wages, penalties, and forfeitures withheld. Service of the notice shall be completed pursuant to Section 1013 of the Code of Civil Procedure by first-class and certified mail to the contractor and subcontractor, if applicable. The notice shall advise the contractor and subcontractor, if applicable, of the procedure for obtaining review of the withholding of contract payments.

The awarding body shall also serve a copy of the notice by certified mail to any bonding company issuing a bond that secures the payment of wages covered by the notice and to any surety on a bond, if their identities are known to the awarding body.

(b) The withholding of contract payments in accordance with Section 1726 or 1771.5 shall be reviewable under Section 1742 in the same manner as if the notice of the withholding was a civil penalty order of the Labor Commissioner under this chapter. If review is requested, the Labor Commissioner may intervene to represent the awarding body.

(c) Pending a final order, or the expiration of the time period for seeking review of the notice of the withholding, the awarding body shall not disburse any contract payments withheld.

(d) From the amount recovered, the wage claim shall be satisfied prior to the amount being applied to penalties. If insufficient money is recovered to pay each worker in full, the money shall be prorated among all workers.

(e) Wages for workers who cannot be located shall be placed in the Industrial Relations Unpaid Wage Fund and held in trust for the workers pursuant to Section 96.7. Penalties shall be paid into the General Fund of the awarding body that has enforced this chapter pursuant to Section 1771.5.

(Repealed and added by Stats. 2000, Ch. 954, Sec. 16. Effective January 1, 2001. Operative July 1, 2001, by Sec. 21 of Ch. 954.)

1771.7. (a) (1) For contracts specified in subdivision (f), an awarding body that chooses to use funds derived from either the Kindergarten-University Public Education Facilities Bond Act of 2002 or the Kindergarten-University Public Education Facilities Bond Act of 2004 for a public works project, shall initiate and enforce, or contract with a third party to initiate and enforce, a labor compliance program, as described in subdivision (b) of Section 1771.5, with respect to that public works project.

(2) If an awarding body described in paragraph (1) chooses to contract with a third party to initiate and enforce a labor compliance program for a project described in paragraph (1), that third party shall not review the payroll records of its own employees or the employees of its subcontractors, and the awarding body or an independent third party shall review these payroll records for purposes of the labor compliance program.

(b) This section applies to public works that commence on or after April 1, 2003. For purposes of this subdivision, work performed during the design and preconstruction phases of construction, including, but not limited to, inspection and land surveying work, does not constitute the commencement of a public work.

(c) (1) For purposes of this section, if any campus of the California State University chooses to use the funds described in subdivision (a), then the "awarding body" is the Chancellor of the California State University. For purposes of this subdivision, if the chancellor is required by subdivision (a) to initiate and enforce, or to contract with a third party to initiate and enforce, a labor compliance program, then in addition to the requirements described in subdivision (b) of Section 1771.5, the Chancellor of the California State University shall review the payroll records on at least a monthly basis to ensure the awarding body's compliance with the labor compliance program.

(2) For purposes of this subdivision, if an awarding body described in subdivision (a) is the University of California or any campus of that university, and that awarding body is required by subdivision (a) to initiate and enforce, or to contract with a third party to initiate and enforce, a labor compliance program, then in addition to the requirements described in subdivision (b) of Section 1771.5, the payroll records shall be reviewed on at least a monthly basis to ensure the awarding body's compliance with the labor compliance program.

(d) (1) An awarding body described in subdivision (a) shall make a written finding that the awarding body has initiated and enforced, or has contracted with a third party to initiate and enforce, the labor compliance program described in subdivision (a).

(2) (A) If an awarding body described in subdivision (a) is a school district, the governing body of that district shall transmit to the State Allocation Board, in the manner determined by that board, a copy of the finding described in paragraph (1).

(B) The State Allocation Board shall not release the funds described in subdivision (a) to an awarding body that is a school district until the State Allocation Board has received the written finding described in paragraph (1).

(C) If the State Allocation Board conducts a postaward audit procedure with respect to an award of the funds described in subdivision (a) to an awarding body that is a school district, the State Allocation Board shall verify, in the manner determined by that board, that the school district has complied with the requirements of this subdivision.

(3) If an awarding body described in subdivision (a) is a community college district, the Chancellor of the California State University, or the office of the President of the University of California or any campus of the University of California, that awarding body shall transmit, in the manner determined by the Director of Industrial Relations, a copy of the finding described in paragraph (1) to the director of that department, or the director of any successor agency that is responsible for the oversight of employee wage and employee work hours laws.

(e) Because the reasonable costs directly related to monitoring and enforcing compliance with the prevailing wage requirements are necessary oversight activities, integral to the cost of construction of the public works projects, notwithstanding Section 17070.63 of the Education Code, the grant amounts as described in Chapter 12.5 (commencing with Section 17070.10) of Part 10 of Division 1 of Title 1 of the Education Code for the costs of a new construction or modernization project shall include the state's share of the reasonable and directly related costs of the labor compliance program used to monitor and enforce compliance with prevailing wage requirements.

(f) This section shall only apply to contracts awarded prior to January 1, 2012.

(Amended by Stats. 2014, Ch. 28, Sec. 68. (SB 854) Effective June 20, 2014.)

1772. Workers employed by contractors or subcontractors in the execution of any contract for public work are deemed to be employed upon public work.

(Amended by Stats. 1992, Ch. 1342, Sec. 7. Effective January 1, 1993.)

1773. The body awarding any contract for public work, or otherwise undertaking any public work, shall obtain the general prevailing rate of per diem wages and the general prevailing rate for holiday and overtime work in the locality in which the public work is to be performed for each craft, classification, or type of worker needed to execute the contract from the Director of Industrial Relations. The holidays upon which those rates shall be paid need not be specified by the awarding body, but shall be all holidays recognized in the applicable collective bargaining agreement. If the prevailing rate is not based on a collectively bargained rate, the holidays upon which the prevailing rate shall be paid shall be as provided in Section 6700 of the Government Code.

In determining the rates, the Director of Industrial Relations shall ascertain and consider the applicable wage rates established by collective bargaining agreements and the rates that may have been predetermined for federal public works, within the locality and in the nearest labor market area. Where the rates do not constitute the rates actually prevailing in the locality, the director shall obtain and consider further data from the labor organizations and employers or employer associations concerned, including the recognized collective bargaining representatives for the particular craft, classification, or type of work involved. The rate fixed for each craft, classification, or type of work shall be not less than the prevailing rate paid in the craft, classification, or type of work.

If the director determines that the rate of prevailing wage for any craft, classification, or type of worker is the rate established by a collective bargaining agreement, the director may adopt that rate by reference as provided for in the collective bargaining agreement and that determination shall be effective for the life of the agreement or until the director determines that another rate should be adopted.

(Amended by Stats. 1999, Ch. 30, Sec. 1. Effective January 1, 2000.)

1773.1. (a) Per diem wages, as the term is used in this chapter or in any other statute applicable to public works, includes employer payments for the following:

- (1) Health and welfare.
- (2) Pension.
- (3) Vacation.

(4) Travel.

(5) Subsistence.

(6) Apprenticeship or other training programs authorized by Section 3093, to the extent that the cost of training is reasonably related to the amount of the contributions.

(7) Worker protection and assistance programs or committees established under the federal Labor Management Cooperation Act of 1978 (29 U.S.C. Sec. 175a), to the extent that the activities of the programs or committees are directed to the monitoring and enforcement of laws related to public works.

(8) Industry advancement and collective bargaining agreements administrative fees, provided that these payments are made pursuant to a collective bargaining agreement to which the employer is obligated.

(9) Other purposes similar to those specified in paragraphs (1) to (5), inclusive; or other purposes similar to those specified in paragraphs (6) to (8), inclusive, if the payments are made pursuant to a collective bargaining agreement to which the employer is obligated.

(b) Employer payments include all of the following:

(1) The rate of contribution irrevocably made by the employer to a trustee or third person pursuant to a plan, fund, or program.

(2) The rate of actual costs to the employer reasonably anticipated in providing benefits to workers pursuant to an enforceable commitment to carry out a financially responsible plan or program communicated in writing to the workers affected.

(3) Payments to the California Apprenticeship Council pursuant to Section 1777.5.

(c) Employer payments are a credit against the obligation to pay the general prevailing rate of per diem wages. However, credit shall not be granted for benefits required to be provided by other state or federal law, for payments made to monitor and enforce laws related to public works if those payments are not made to a program or committee established under the federal Labor Management Cooperation Act of 1978 (29 U.S.C. Sec. 175a), or for payments for industry advancement and collective bargaining agreement administrative fees if those payments are not made pursuant to a collective bargaining agreement to which the employer is obligated. Credits for employer payments also shall not reduce the obligation to pay the hourly straight time or overtime wages found to be prevailing. However, an increased employer payment contribution that results in a lower hourly straight time or overtime wage shall not be considered a violation of the applicable prevailing wage determination if all of the following conditions are met:

(1) The increased employer payment is made pursuant to criteria set forth in a collective bargaining agreement.

(2) The basic hourly rate and increased employer payment are no less than the general prevailing rate of per diem wages and the general prevailing rate for holiday and overtime work in the director's general prevailing wage determination.

(3) The employer payment contribution is irrevocable unless made in error.

(d) An employer may take credit for an employer payment specified in subdivision (b), even if contributions are not made, or costs are not paid, during the same pay period for which credit is taken, if the employer regularly makes the contributions, or regularly pays the costs, for the plan, fund, or program on no less than a quarterly basis.

(e) The credit for employer payments shall be computed on an annualized basis when the employer seeks credit for employer payments that are higher for public works projects than for private construction performed by the same employer, unless one or more of the following occur:

(1) The employer has an enforceable obligation to make the higher rate of payments on future private construction performed by the employer.

(2) The higher rate of payments is required by a project labor agreement.

(3) The payments are made to the California Apprenticeship Council pursuant to Section 1777.5.

(4) The director determines that annualization would not serve the purposes of this chapter.

(f) (1) For the purpose of determining those per diem wages for contracts, the representative of any craft, classification, or type of worker needed to execute contracts shall file with the Department of Industrial Relations

fully executed copies of the collective bargaining agreements for the particular craft, classification, or type of work involved. The collective bargaining agreements shall be filed after their execution and thereafter may be taken into consideration pursuant to Section 1773 whenever they are filed 30 days prior to the call for bids. If the collective bargaining agreement has not been formalized, a typescript of the final draft may be filed temporarily, accompanied by a statement under penalty of perjury as to its effective date.

(2) When a copy of the collective bargaining agreement has previously been filed, fully executed copies of all modifications and extensions of the agreement that affect per diem wages or holidays shall be filed.

(3) The failure to comply with filing requirements of this subdivision shall not be grounds for setting aside a prevailing wage determination if the information taken into consideration is correct.

(Amended by Stats. 2016, Ch. 231, Sec. 1. (SB 954) Effective January 1, 2017.)

1773.2. The body awarding any contract for public work, or otherwise undertaking any public work, shall specify in the call for bids for the contract, and in the bid specifications and in the contract itself, what the general rate of per diem wages is for each craft, classification, or type of worker needed to execute the contract.

In lieu of specifying the rate of wages in the call for bids, and in the bid specifications and in the contract itself, the awarding body may, in the call for bids, bid specifications, and contract, include a statement that copies of the prevailing rate of per diem wages are on file at its principal office, which shall be made available to any interested party on request. The awarding body shall also cause a copy of the determination of the director of the prevailing rate of per diem wages to be posted at each job site.

(Amended by Stats. 1992, Ch. 1342, Sec. 8. Effective January 1, 1993.)

1773.3. (a) (1) An awarding body shall provide notice to the Department of Industrial Relations of any public works contract subject to the requirements of this chapter, within 30 days of the award, but in no event later than the first day in which a contractor has workers employed upon the public work.

(2) Notwithstanding paragraph (1) and subject to the discretion of the Labor Commissioner, an awarding body shall provide notice to the Department of Industrial Relations of any public works contract awarded pursuant to Section 10122, 20113, 20654, or 22050 of the Public Contract Code that is subject to the requirements of this chapter within 30 days after the award of the contract, but in no event later than the last day in which a contractor has workers employed upon the public work.

(3) The notice shall be transmitted electronically in a format specified by the department and shall include the name and registration number issued by the Department of Industrial Relations pursuant to Section 1725.5 of the contractor, the name and registration number issued by the Department of Industrial Relations pursuant to Section 1725.5 of any subcontractor listed on the successful bid, the bid and contract award dates, the contract amount, the estimated start and completion dates, jobsite location, and any additional information the department specifies that aids in the administration and enforcement of this chapter.

(b) In lieu of responding to any specific request for contract award information, the department may make the information provided by awarding bodies pursuant to this section available for public review on its Internet Web site.

(c) (1) An awarding body that fails to provide the notice required by subdivision (a) or that enters into a contract with or permits an unregistered contractor or subcontractor to engage in the performance of any public work in violation of the requirements of Section 1771.1, shall, in addition to any other sanction or penalty authorized by law, be subject to a civil penalty of one hundred dollars (\$100) for each day in violation of either requirement, not to exceed an aggregate penalty of ten thousand dollars (\$10,000) for each project.

(2) The Labor Commissioner shall use the same standards specified in subparagraph (A) of paragraph (2) of subdivision (a) of Section 1775 when determining the severity of the violation and what penalty to assess, and may waive the penalty for a first time violation that was unintentional and did not hinder the Labor Commissioner's ability to monitor and enforce compliance with the requirements of this chapter.

(d) An awarding body shall withhold final payment due to the contractor until at least 30 days after all of the required information in paragraph (2) of subdivision (a) has been submitted, including, but not limited to, providing a complete list of all subcontractors. If an awarding body makes a final payment to a contractor after that time and an unregistered contractor or subcontractor is found to have worked on the project, the awarding body shall be subject to a civil penalty assessed by the Labor Commissioner of one hundred dollars (\$100) for each full calendar day of noncompliance, for a period of up to 100 days, for each unregistered contractor or subcontractor.

(e) The Labor Commissioner may issue a citation for civil penalties to the awarding body pursuant to subdivisions (c) and (d). The citation shall be served pursuant to Section 1013 of the Code of Civil Procedure by first-class and certified mail.

(f) The procedure for the processing and appeal of a citation or civil penalty issued by the Labor Commissioner pursuant to this section shall be the same as that prescribed in Section 1023. For these purposes, "person" as used in Section 1023 shall include an awarding body.

(g) Whenever the Labor Commissioner determines that an awarding body has willfully violated the requirements of this section or chapter with respect to two or more public works contracts or projects in any 12-month period, the awarding body shall be ineligible to receive state funding or financial assistance for any construction project undertaken by or on behalf of the awarding body for one year, as defined by subdivision (d) of Section 1782. The debarment procedures adopted by the Labor Commissioner pursuant to Section 1777.1 shall apply to any determination made under this subdivision.

(h) A contractor or subcontractor shall not be liable for any penalties assessed against an awarding body pursuant to this section. An awarding body may not require a contractor or subcontractor to indemnify or otherwise be liable for any penalties assessed against an awarding body pursuant to this section.

(i) Penalties received pursuant to this section shall be deposited in the State Public Works Enforcement Fund established by Section 1771.3 and shall be used only for the purposes specified in that section.

(j) This section shall apply only if the public works contract is for a project of greater than twenty-five thousand dollars (\$25,000) when the project is for construction, alteration, demolition, installation, or repair work or if the public works contract is for a project of greater than fifteen thousand dollars (\$15,000) when the project is for maintenance work.

(Amended by Stats. 2018, Ch. 455, Sec. 3. (SB 877) Effective September 17, 2018.)

1773.4. Any prospective bidder or his representative, any representative of any craft, classification or type of workman involved, or the awarding body may, within 20 days after commencement of advertising of the call for bids by the awarding body, file with the Director of Industrial Relations a verified petition to review the determination of any such rate or rates upon the ground that they have not been determined in accordance with the provision of Section 1773 of this code. Within two days thereafter, a copy of such petition shall be filed with the awarding body. The petition shall set forth the facts upon which it is based. The Director of Industrial Relations or his authorized representative shall, upon notice to the petitioner, the awarding body and such other persons as he deems proper, including the recognized collective bargaining representatives for the particular crafts, classifications or types of work involved, institute an investigation or hold a hearing. Within 20 days after the filing of such petition, or within such longer period as agreed upon by the director, the awarding body, and all the interested parties, he shall make a determination and transmit the same in writing to the awarding body and to the interested parties.

Such determination shall be final and shall be the determination of the awarding body. Upon receipt by it of the notice of the filing of such petition the body awarding the contract or authorizing the public work shall extend the closing date for the submission of bids or the starting of work until five days after the determination of the general prevailing rates of per diem wages pursuant to this section.

Upon the filing of any such petition, notice thereof shall be set forth in the next and all subsequent publications by the awarding body of the call for bids. No other notice need be given to bidders by the awarding body by publication or otherwise. The determination of the director shall be included in the contract.

(Amended by Stats. 1969, Ch. 301.)

1773.5. (a) The Director of Industrial Relations may establish rules and regulations for the purpose of carrying out this chapter, including, but not limited to, the responsibilities and duties of awarding bodies under this chapter.

(b) When a request is made to the director for a determination of whether a specific project or type of work awarded or undertaken by a political subdivision is a public work, he or she shall make that determination within 60 days receipt of the last notice of support or opposition from any interested party relating to that project or type of work that was not unreasonably delayed, as determined by the director. If the director deems that the complexity of the request requires additional time to make that determination, the director may have up to an additional 60 days if he or she certifies in writing to the requestor, and any interested party, the reasons for the extension. If the requestor is not a political subdivision, the requestor shall, within 15 days of the request, serve a copy of the request upon the political subdivision, in which event the political subdivision shall, within 30 days of its receipt, advise the director of its position regarding the request. For projects or types of work that are otherwise private development projects receiving public funds, as specified in subdivision (b) of Section 1720, the director shall

determine whether a specific project or type of work is a public work within 120 days of receipt of the last notice of support or opposition relating to that project or type of work from any interested party that was not unreasonably delayed, as determined by the director.

(c) If an administrative appeal of the director's determination is made, it shall be made within 30 days of the date of the determination. The director shall issue a determination on the administrative appeal within 120 days after receipt of the last notice of support or opposition relating to that appeal from any interested party that was not unreasonably delayed, as determined by the director. The director may have up to an additional 60 days if he or she certifies in writing to the party requesting the appeal the reason for the extension.

(d) The director shall have quasi-legislative authority to determine coverage of projects or types of work under the prevailing wage laws of this chapter. A final determination on any administrative appeal is subject to judicial review pursuant to Section 1085 of the Code of Civil Procedure. These determinations, and any determinations relating to the general prevailing rate of per diem wages and the general prevailing rate for holiday, shift rate, and overtime work, shall be exempt from the Administrative Procedure Act (Chapter 3.5 (commencing with Section 11340) of Part 1 of Division 3 of Title 2 of the Government Code).

(Amended by Stats. 2013, Ch. 780, Sec. 3. (SB 377) Effective January 1, 2014.)

1773.6. If during any quarterly period the Director of Industrial Relations shall determine that there has been a change in any prevailing rate of per diem wages in any locality he or she shall make such change available to the awarding body and his or her determination shall be final. Such determination by the Director of Industrial Relations shall not be effective as to any contract for which the notice to bidders has been published.

(Amended by Stats. 2017, Ch. 28, Sec. 22. (SB 96) Effective June 27, 2017.)

1773.7. The provisions of Section 11250 of the Government Code shall not be applicable to Sections 1773, 1773.4, and 1773.6.

(Repealed and added by Stats. 1976, Ch. 281.)

1773.8. An increased employer payment contribution that results in a lower taxable wage shall not be considered a violation of the applicable prevailing wage determination so long as all of the following conditions are met:

- (a) The increased employer payment is made pursuant to criteria set forth in a collective bargaining agreement.
- (b) The increased employer payment and hourly straight time and overtime wage combined are no less than the general prevailing rate of per diem wages.
- (c) The employer payment contribution is irrevocable unless made in error.

(Added by Stats. 2012, Ch. 827, Sec. 2. (AB 2677) Effective January 1, 2013.)

1773.9. (a) The Director of Industrial Relations shall use the methodology set forth in subdivision (b) to determine the general prevailing rate of per diem wages in the locality in which the public work is to be performed.

(b) The general prevailing rate of per diem wages includes all of the following:

- (1) The basic hourly wage rate being paid to a majority of workers engaged in the particular craft, classification, or type of work within the locality and in the nearest labor market area, if a majority of the workers is paid at a single rate. If no single rate is being paid to a majority of the workers, then the single rate being paid to the greatest number of workers, or modal rate, is prevailing. If a modal rate cannot be determined, then the director shall establish an alternative rate, consistent with the methodology for determining the modal rate, by considering the appropriate collective bargaining agreements, federal rates, rates in the nearest labor market area, or other data such as wage survey data.
- (2) Other employer payments included in per diem wages pursuant to Section 1773.1 and as included as part of the total hourly wage rate from which the basic hourly wage rate was derived. In the event the total hourly wage rate does not include any employer payments, the director shall establish a prevailing employer payment rate by the same procedure set forth in paragraph (1).
- (3) The rate for holiday and overtime work shall be those rates specified in the collective bargaining agreement when the basic hourly rate is based on a collective bargaining agreement rate. In the event the basic hourly rate is not based on a collective bargaining agreement, the rate for holidays and overtime work, if any, included with the prevailing basic hourly rate of pay shall be prevailing.

(c) (1) If the director determines that the general prevailing rate of per diem wages is the rate established by a collective bargaining agreement, and that the collective bargaining agreement contains definite and predetermined changes during its term that will affect the rate adopted, the director shall incorporate those changes into the determination. Predetermined changes that are rescinded prior to their effective date shall not be enforced.

(2) When the director determines that there is a definite and predetermined change in the general prevailing rate of per diem wages as described in paragraph (1), but has not published, at the time of the effective date of the predetermined change, the allocation of the predetermined change as between the basic hourly wage and other employer payments included in per diem wages pursuant to Section 1773.1, a contractor or subcontractor may allocate payments of not less than the amount of the definite and predetermined change to either the basic hourly wage or other employer payments included in per diem wages for up to 60 days following the director's publication of the specific allocation of the predetermined change.

(3) When the director determines that there is a definite and predetermined change in the general prevailing rate of per diem wages as described in paragraph (1), but the allocation of that predetermined change as between the basic hourly wage and other employer payments included in per diem wages pursuant to Section 1773.1 is subsequently altered by the parties to a collective bargaining agreement described in paragraph (1), a contractor or subcontractor may allocate payments of not less than the amount of the definite and predetermined change in accordance with either the originally published allocation or the allocation as altered in the collective bargaining agreement.

(Amended by Stats. 2007, Ch. 482, Sec. 2. Effective January 1, 2008.)

1773.11. (a) Notwithstanding any other provision of law and except as otherwise provided by this section, if the state or a political subdivision thereof agrees by contract with a private entity that the private entity's employees receive, in performing that contract, the general prevailing rate of per diem wages and the general prevailing rate for holiday and overtime work, the director shall, upon a request by the state or the political subdivision, do both of the following:

(1) Determine, as otherwise provided by law, the wage rates for each craft, classification, or type of worker that are needed to execute the contract.

(2) Provide these wage rates to the state or political subdivision that requests them.

(b) This section does not apply to a contract for a public work, as defined in this chapter.

(c) The director shall determine and provide the wage rates described in this section in the order in which the requests for these wage rates were received and regardless of the calendar year in which they were received. If there are more than 20 pending requests in a calendar year, the director shall respond only to the first 20 requests in the order in which they were received. If the director determines that funding is available in any calendar year to determine and provide these wage rates in response to more than 20 requests, the director shall respond to these requests in a manner consistent with this subdivision.

(Added by Stats. 2003, Ch. 343, Sec. 1. Effective January 1, 2004.)

1774. The contractor to whom the contract is awarded, and any subcontractor under him, shall pay not less than the specified prevailing rates of wages to all workmen employed in the execution of the contract.

(Enacted by Stats. 1937, Ch. 90.)

1775. (a) (1) The contractor and any subcontractor under the contractor shall, as a penalty to the state or political subdivision on whose behalf the contract is made or awarded, forfeit not more than two hundred dollars (\$200) for each calendar day, or portion thereof, for each worker paid less than the prevailing wage rates as determined by the director for the work or craft in which the worker is employed for any public work done under the contract by the contractor or, except as provided in subdivision (b), by any subcontractor under the contractor.

(2) (A) The amount of the penalty shall be determined by the Labor Commissioner based on consideration of both of the following:

(i) Whether the failure of the contractor or subcontractor to pay the correct rate of per diem wages was a good faith mistake and, if so, the error was promptly and voluntarily corrected when brought to the attention of the contractor or subcontractor.

(ii) Whether the contractor or subcontractor has a prior record of failing to meet its prevailing wage obligations.

(B) (i) The penalty may not be less than forty dollars (\$40) for each calendar day, or portion thereof, for each worker paid less than the prevailing wage rate, unless the failure of the contractor or subcontractor to pay the correct rate of per diem wages was a good faith mistake and, if so, the error was promptly and voluntarily corrected when brought to the attention of the contractor or subcontractor.

(ii) The penalty may not be less than eighty dollars (\$80) for each calendar day, or portion thereof, for each worker paid less than the prevailing wage rate, if the contractor or subcontractor has been assessed penalties within the previous three years for failing to meet its prevailing wage obligations on a separate contract, unless those penalties were subsequently withdrawn or overturned.

(iii) The penalty may not be less than one hundred twenty dollars (\$120) for each calendar day, or portion thereof, for each worker paid less than the prevailing wage rate, if the Labor Commissioner determines that the violation was willful, as defined in subdivision (c) of Section 1777.1.

(C) If the amount due under this section is collected from the contractor or subcontractor, any outstanding wage claim under Chapter 1 (commencing with Section 1720) of Part 7 of Division 2 against that contractor or subcontractor shall be satisfied before applying that amount to the penalty imposed on that contractor or subcontractor pursuant to this section.

(D) The determination of the Labor Commissioner as to the amount of the penalty shall be reviewable only for abuse of discretion.

(E) The difference between the prevailing wage rates and the amount paid to each worker for each calendar day or portion thereof for which each worker was paid less than the prevailing wage rate shall be paid to each worker by the contractor or subcontractor, and the body awarding the contract shall cause to be inserted in the contract a stipulation that this section will be complied with.

(b) If a worker employed by a subcontractor on a public works project is not paid the general prevailing rate of per diem wages by the subcontractor, the prime contractor of the project is not liable for any penalties under subdivision (a) unless the prime contractor had knowledge of that failure of the subcontractor to pay the specified prevailing rate of wages to those workers or unless the prime contractor fails to comply with all of the following requirements:

(1) The contract executed between the contractor and the subcontractor for the performance of work on the public works project shall include a copy of the provisions of this section and Sections 1771, 1776, 1777.5, 1813, and 1815.

(2) The contractor shall monitor the payment of the specified general prevailing rate of per diem wages by the subcontractor to the employees, by periodic review of the certified payroll records of the subcontractor.

(3) Upon becoming aware of the failure of the subcontractor to pay his or her workers the specified prevailing rate of wages, the contractor shall diligently take corrective action to halt or rectify the failure, including, but not limited to, retaining sufficient funds due the subcontractor for work performed on the public works project.

(4) Prior to making final payment to the subcontractor for work performed on the public works project, the contractor shall obtain an affidavit signed under penalty of perjury from the subcontractor that the subcontractor has paid the specified general prevailing rate of per diem wages to his or her employees on the public works project and any amounts due pursuant to Section 1813.

(c) The Division of Labor Standards Enforcement shall notify the contractor on a public works project within 15 days of the receipt by the Division of Labor Standards Enforcement of a complaint of the failure of a subcontractor on that public works project to pay workers the general prevailing rate of per diem wages.

(Amended by Stats. 2011, Ch. 677, Sec. 1. (AB 551) Effective January 1, 2012.)

1776. (a) Each contractor and subcontractor shall keep accurate payroll records, showing the name, address, social security number, work classification, straight time and overtime hours worked each day and week, and the actual per diem wages paid to each journeyman, apprentice, worker, or other employee employed by him or her in connection with the public work. Each payroll record shall contain or be verified by a written declaration that it is made under penalty of perjury, stating both of the following:

(1) The information contained in the payroll record is true and correct.

(2) The employer has complied with the requirements of Sections 1771, 1811, and 1815 for any work performed by his or her employees on the public works project.

(b) The payroll records enumerated under subdivision (a) shall be certified and shall be available for inspection at all reasonable hours at the principal office of the contractor on the following basis:

(1) A certified copy of an employee's payroll record shall be made available for inspection or furnished to the employee or his or her authorized representative on request.

(2) A certified copy of all payroll records enumerated in subdivision (a) shall be made available for inspection or furnished upon request to a representative of the body awarding the contract and the Division of Labor Standards Enforcement of the Department of Industrial Relations.

(3) A certified copy of all payroll records enumerated in subdivision (a) shall be made available upon request by the public for inspection or for copies thereof. However, a request by the public shall be made through either the body awarding the contract or the Division of Labor Standards Enforcement. If the requested payroll records have not been provided pursuant to paragraph (2), the requesting party shall, prior to being provided the records, reimburse the costs of preparation by the contractor, subcontractors, and the entity through which the request was made. The public may not be given access to the records at the principal office of the contractor.

(c) Unless required to be furnished directly to the Labor Commissioner in accordance with paragraph (3) of subdivision (a) of Section 1771.4, the certified payroll records shall be on forms provided by the Division of Labor Standards Enforcement or shall contain the same information as the forms provided by the division. The payroll records may consist of printouts of payroll data that are maintained as computer records, if the printouts contain the same information as the forms provided by the division and the printouts are verified in the manner specified in subdivision (a).

(d) A contractor or subcontractor shall file a certified copy of the records enumerated in subdivision (a) with the entity that requested the records within 10 days after receipt of a written request.

(e) Except as provided in subdivision (f), any copy of records made available for inspection as copies and furnished upon request to the public or any public agency by the awarding body or the Division of Labor Standards Enforcement shall be marked or obliterated to prevent disclosure of an individual's name, address, and social security number. The name and address of the contractor awarded the contract or the subcontractor performing the contract shall not be marked or obliterated. Any copy of records made available for inspection by, or furnished to, a multiemployer Taft-Hartley trust fund (29 U.S.C. Sec. 186(c)(5)) that requests the records for the purposes of allocating contributions to participants shall be marked or obliterated only to prevent disclosure of an individual's full social security number, but shall provide the last four digits of the social security number. Any copy of records made available for inspection by, or furnished to, a joint labor-management committee established pursuant to the federal Labor Management Cooperation Act of 1978 (29 U.S.C. Sec. 175a) shall be marked or obliterated only to prevent disclosure of an individual's social security number.

(f) (1) Notwithstanding any other provision of law, agencies that are included in the Joint Enforcement Strike Force on the Underground Economy established pursuant to Section 329 of the Unemployment Insurance Code and other law enforcement agencies investigating violations of law shall, upon request, be provided nonredacted copies of certified payroll records. Any copies of records or certified payroll made available for inspection and furnished upon request to the public by an agency included in the Joint Enforcement Strike Force on the Underground Economy or to a law enforcement agency investigating a violation of law shall be marked or redacted to prevent disclosure of an individual's name, address, and social security number.

(2) An employer shall not be liable for damages in a civil action for any reasonable act or omission taken in good faith in compliance with this subdivision.

(g) The contractor shall inform the body awarding the contract of the location of the records enumerated under subdivision (a), including the street address, city, and county, and shall, within five working days, provide a notice of a change of location and address.

(h) The contractor or subcontractor has 10 days in which to comply subsequent to receipt of a written notice requesting the records enumerated in subdivision (a). In the event that the contractor or subcontractor fails to comply within the 10-day period, he or she shall, as a penalty to the state or political subdivision on whose behalf the contract is made or awarded, forfeit one hundred dollars (\$100) for each calendar day, or portion thereof, for each worker, until strict compliance is effectuated. Upon the request of the Division of Labor Standards Enforcement, these penalties shall be withheld from progress payments then due. A contractor is not subject to a penalty assessment pursuant to this section due to the failure of a subcontractor to comply with this section.

(i) The body awarding the contract shall cause to be inserted in the contract stipulations to effectuate this section.

(j) The director shall adopt rules consistent with the California Public Records Act (Chapter 3.5 (commencing with Section 6250) of Division 7 of Title 1 of the Government Code) and the Information Practices Act of 1977 (Title 1.8

(commencing with Section 1798) of Part 4 of Division 3 of the Civil Code) governing the release of these records, including the establishment of reasonable fees to be charged for reproducing copies of records required by this section.

(Amended by Stats. 2014, Ch. 28, Sec. 71. (SB 854) Effective June 20, 2014. Superseded on January 1, 2023; see amendment by Stats. 2021, Ch. 615.)

1776. (a) Each contractor and subcontractor shall keep accurate payroll records, showing the name, address, social security number, work classification, straight time and overtime hours worked each day and week, and the actual per diem wages paid to each journeyman, apprentice, worker, or other employee employed by the contractor or subcontractor in connection with the public work. Each payroll record shall contain or be verified by a written declaration that it is made under penalty of perjury, stating both of the following:

(1) The information contained in the payroll record is true and correct.

(2) The employer has complied with the requirements of Sections 1771, 1811, and 1815 for any work performed by that person's employees on the public works project.

(b) The payroll records enumerated under subdivision (a) shall be certified and shall be available for inspection at all reasonable hours at the principal office of the contractor on the following basis:

(1) A certified copy of an employee's payroll record shall be made available for inspection or furnished to the employee or the employee's authorized representative on request.

(2) A certified copy of all payroll records enumerated in subdivision (a) shall be made available for inspection or furnished upon request to a representative of the body awarding the contract and the Division of Labor Standards Enforcement of the Department of Industrial Relations.

(3) A certified copy of all payroll records enumerated in subdivision (a) shall be made available upon request by the public for inspection or for copies thereof. However, a request by the public shall be made through either the body awarding the contract or the Division of Labor Standards Enforcement. If the requested payroll records have not been provided pursuant to paragraph (2), the requesting party shall, prior to being provided the records, reimburse the costs of preparation by the contractor, subcontractors, and the entity through which the request was made. The public may not be given access to the records at the principal office of the contractor.

(c) Unless required to be furnished directly to the Labor Commissioner in accordance with paragraph (3) of subdivision (a) of Section 1771.4, the certified payroll records shall be on forms provided by the Division of Labor Standards Enforcement or shall contain the same information as the forms provided by the division. The payroll records may consist of printouts of payroll data that are maintained as computer records, if the printouts contain the same information as the forms provided by the division and the printouts are verified in the manner specified in subdivision (a).

(d) A contractor or subcontractor shall file a certified copy of the records enumerated in subdivision (a) with the entity that requested the records within 10 days after receipt of a written request.

(e) Except as provided in subdivision (f), any copy of records made available for inspection as copies and furnished upon request to the public or any public agency by the awarding body or the Division of Labor Standards Enforcement shall be marked or obliterated to prevent disclosure of an individual's name, address, and social security number. The name and address of the contractor awarded the contract or the subcontractor performing the contract shall not be marked or obliterated. Any copy of records made available for inspection by, or furnished to, a multiemployer Taft-Hartley trust fund (29 U.S.C. Sec. 186(c)(5)) that requests the records for the purposes of allocating contributions to participants shall be marked or obliterated only to prevent disclosure of an individual's full social security number, but shall provide the last four digits of the social security number. Any copy of records made available for inspection by, or furnished to, a joint labor-management committee established pursuant to the federal Labor Management Cooperation Act of 1978 (29 U.S.C. Sec. 175a) shall be marked or obliterated only to prevent disclosure of an individual's social security number.

(f) (1) Notwithstanding any other provision of law, agencies that are included in the Joint Enforcement Strike Force on the Underground Economy established pursuant to Section 329 of the Unemployment Insurance Code and other law enforcement agencies investigating violations of law shall, upon request, be provided nonredacted copies of certified payroll records. Any copies of records or certified payroll made available for inspection and furnished upon request to the public by an agency included in the Joint Enforcement Strike Force on the Underground Economy or to a law enforcement agency investigating a violation of law shall be marked or redacted to prevent disclosure of an individual's name, address, and social security number.

(2) An employer shall not be liable for damages in a civil action for any reasonable act or omission taken in good faith in compliance with this subdivision.

(g) The contractor shall inform the body awarding the contract of the location of the records enumerated under subdivision (a), including the street address, city, and county, and shall, within five working days, provide a notice of a change of location and address.

(h) The contractor or subcontractor has 10 days in which to comply subsequent to receipt of a written notice requesting the records enumerated in subdivision (a). In the event that the contractor or subcontractor fails to comply within the 10-day period, the contractor or subcontractor shall, as a penalty to the state or political subdivision on whose behalf the contract is made or awarded, forfeit one hundred dollars (\$100) for each calendar day, or portion thereof, for each worker, until strict compliance is effectuated. Upon the request of the Division of Labor Standards Enforcement, these penalties shall be withheld from progress payments then due. A contractor is not subject to a penalty assessment pursuant to this section due to the failure of a subcontractor to comply with this section.

(i) The body awarding the contract shall cause to be inserted in the contract stipulations to effectuate this section.

(j) The director shall adopt rules consistent with the California Public Records Act (Division 10 (commencing with Section 7920.000) of Title 1 of the Government Code) and the Information Practices Act of 1977 (Title 1.8 (commencing with Section 1798) of Part 4 of Division 3 of the Civil Code) governing the release of these records, including the establishment of reasonable fees to be charged for reproducing copies of records required by this section.

(Amended by Stats. 2021, Ch. 615, Sec. 321. (AB 474) Effective January 1, 2022. Operative January 1, 2023, pursuant to Sec. 463 of Stats. 2021, Ch. 615.)

1777. Any officer, agent, or representative of the State or of any political subdivision who wilfully violates any provision of this article, and any contractor, or subcontractor, or agent or representative thereof, doing public work who neglects to comply with any provision of section 1776 is guilty of a misdemeanor.

(Enacted by Stats. 1937, Ch. 90.)

1777.1. (a) Whenever a contractor or subcontractor performing a public works project pursuant to this chapter is found by the Labor Commissioner to be in violation of this chapter with intent to defraud, the contractor or subcontractor or a firm, corporation, partnership, or association in which the contractor or subcontractor has any interest is ineligible for a period of not less than one year or more than three years to do either of the following:

- (1) Bid on or be awarded a contract for a public works project.
- (2) Perform work as a subcontractor on a public works project.

(b) Whenever a contractor or subcontractor performing a public works project pursuant to this chapter is found by the Labor Commissioner to have committed two or more separate willful violations of this chapter within a three-year period, the contractor or subcontractor or a firm, corporation, partnership, or association in which the contractor or subcontractor has any interest is ineligible for a period up to three years to do either of the following:

- (1) Bid on or be awarded a contract for a public works project.
- (2) Perform work as a subcontractor on a public works project.

(c) Whenever a contractor or subcontractor performing a public works project has failed to provide a timely response to a request by the Division of Labor Standards Enforcement, the Division of Apprenticeship Standards, or the awarding body to produce certified payroll records pursuant to Section 1776, the Labor Commissioner shall notify the contractor or subcontractor that, in addition to any other penalties provided by law, the contractor or subcontractor will be subject to debarment under this section if the certified payroll records are not produced within 30 days after receipt of the written notice. If the commissioner finds that the contractor or subcontractor has failed to comply with Section 1776 by that deadline, unless the commissioner finds that the failure to comply was due to circumstances outside the contractor's or subcontractor's control, the contractor or subcontractor or a firm, corporation, partnership, or association in which the contractor or subcontractor has any interest is ineligible for a period of not less than one year and not more than three years to do either of the following:

- (1) Bid on or be awarded a contract for a public works project.
- (2) Perform work as a subcontractor on a public works project.

(d) (1) In the event a contractor or subcontractor is determined by the Labor Commissioner to have knowingly committed a serious violation of any provision of Section 1777.5, the Labor Commissioner may also deny to the contractor or subcontractor, and to its responsible officers, the right to bid on or to be awarded or perform work as a subcontractor on any public works contract for a period of up to one year for the first violation and for a period of up to three years for a second or subsequent violation. Each period of debarment shall run from the date the determination of noncompliance by the Labor Commissioner becomes a final order.

(2) The Labor Commissioner shall consider, in determining whether a violation is serious, and in determining whether and for how long a party should be debarred for violating Section 1777.5, all of the following circumstances:

(A) Whether the violation was intentional.

(B) Whether the party has committed other violations of Section 1777.5.

(C) Whether, upon notice of the violation, the party took steps to voluntarily remedy the violation.

(D) Whether, and to what extent, the violation resulted in lost training opportunities for apprentices.

(E) Whether, and to what extent, the violation otherwise harmed apprentices or apprenticeship programs.

(e) A willful violation occurs when the contractor or subcontractor knew or reasonably should have known of his or her obligations under the public works law and deliberately fails or deliberately refuses to comply with its provisions.

(f) The Labor Commissioner shall publish on the commissioner's Internet Web site a list of contractors who are ineligible to bid on or be awarded a public works contract, or to perform work as a subcontractor on a public works project pursuant to this chapter. The list shall contain the name of the contractor, the Contractors' State License Board license number of the contractor, and the effective period of debarment of the contractor. Contractors shall be added to the list upon issuance of a debarment order and the commissioner shall also notify the Contractors' State License Board when the list is updated. At least annually, the commissioner shall notify awarding bodies of the availability of the list of debarred contractors. The commissioner shall also place advertisements in construction industry publications targeted to the contractors and subcontractors, chosen by the commissioner, that state the effective period of the debarment and the reason for debarment. The advertisements shall appear one time for each debarment of a contractor in each publication chosen by the commissioner. The debarred contractor or subcontractor shall be liable to the commissioner for the reasonable cost of the advertisements, not to exceed five thousand dollars (\$5,000). The amount paid to the commissioner for the advertisements shall be credited against the contractor's or subcontractor's obligation to pay civil fines or penalties for the same willful violation of this chapter.

(g) For purposes of this section, "contractor or subcontractor" means a firm, corporation, partnership, or association and its responsible managing officer, as well as any supervisors, managers, and officers found by the Labor Commissioner to be personally and substantially responsible for the willful violation of this chapter.

(h) For the purposes of this section, the term "any interest" means an interest in the entity bidding or performing work on the public works project, whether as an owner, partner, officer, manager, employee, agent, consultant, or representative. "Any interest" includes, but is not limited to, all instances where the debarred contractor or subcontractor receives payments, whether cash or any other form of compensation, from any entity bidding or performing work on the public works project, or enters into any contracts or agreements with the entity bidding or performing work on the public works project for services performed or to be performed for contracts that have been or will be assigned or sublet, or for vehicles, tools, equipment, or supplies that have been or will be sold, rented, or leased during the period from the initiation of the debarment proceedings until the end of the term of the debarment period. "Any interest" does not include shares held in a publicly traded corporation if the shares were not received as compensation after the initiation of debarment from an entity bidding or performing work on a public works project.

(i) For the purposes of this section, the term "entity" is defined as a company, limited liability company, association, partnership, sole proprietorship, limited liability partnership, corporation, business trust, or organization.

(j) The Labor Commissioner shall adopt rules and regulations for the administration and enforcement of this section.

(Amended by Stats. 2014, Ch. 297, Sec. 1. (AB 2744) Effective January 1, 2015.)

1777.5. (a) (1) This chapter does not prevent the employment upon public works of properly registered apprentices who are active participants in an approved apprenticeship program.

(2) For purposes of this chapter, "apprenticeship program" means a program under the jurisdiction of the California Apprenticeship Council established pursuant to Section 3070.

(b) (1) Every apprentice employed upon public works shall be paid the prevailing rate of per diem wages for apprentices in the trade to which he or she is registered and shall be employed only at the work of the craft or trade to which he or she is registered.

(2) Unless otherwise provided by a collective bargaining agreement, when a contractor requests the dispatch of an apprentice pursuant to this section to perform work on a public works project and requires the apprentice to fill out an application or undergo testing, training, an examination, or other preemployment process as a condition of employment, the apprentice shall be paid for the time spent on the required preemployment activity, including travel time to and from the required activity, if any, at the prevailing rate of per diem wages for apprentices in the trade to which he or she is registered. Unless otherwise provided by a collective bargaining agreement, a contractor is not required to compensate an apprentice for the time spent on preemployment activities if the apprentice is required to take a preemployment drug or alcohol test and he or she fails to pass that test.

(c) Only apprentices, as defined in Section 3077, who are in training under apprenticeship standards that have been approved by the Chief of the Division of Apprenticeship Standards and who are parties to written apprentice agreements under Chapter 4 (commencing with Section 3070) of Division 3 are eligible to be employed at the apprentice wage rate on public works. The employment and training of each apprentice shall be in accordance with either of the following:

(1) The apprenticeship standards and apprentice agreements under which he or she is training.

(2) The rules and regulations of the California Apprenticeship Council.

(d) If the contractor to whom the contract is awarded by the state or any political subdivision, in performing any of the work under the contract, employs workers in any apprenticeable craft or trade, the contractor shall employ apprentices in at least the ratio set forth in this section and may apply to any apprenticeship program in the craft or trade that can provide apprentices to the site of the public work for a certificate approving the contractor under the apprenticeship standards for the employment and training of apprentices in the area or industry affected. However, the decision of the apprenticeship program to approve or deny a certificate shall be subject to review by the Administrator of Apprenticeship. The apprenticeship program or programs, upon approving the contractor, shall arrange for the dispatch of apprentices to the contractor. A contractor covered by an apprenticeship program's standards shall not be required to submit any additional application in order to include additional public works contracts under that program. "Apprenticeable craft or trade," as used in this section, means a craft or trade determined as an apprenticeable occupation in accordance with rules and regulations prescribed by the California Apprenticeship Council. As used in this section, "contractor" includes any subcontractor under a contractor who performs any public works not excluded by subdivision (o).

(e) Before commencing work on a contract for public works, every contractor shall submit contract award information to an applicable apprenticeship program that can supply apprentices to the site of the public work. The information submitted shall include an estimate of journeyman hours to be performed under the contract, the number of apprentices proposed to be employed, and the approximate dates the apprentices would be employed. A copy of this information shall also be submitted to the awarding body, if requested by the awarding body. Within 60 days after concluding work on the contract, each contractor and subcontractor shall submit to the awarding body, if requested, and to the apprenticeship program a verified statement of the journeyman and apprentice hours performed on the contract. The information under this subdivision shall be public. The apprenticeship programs shall retain this information for 12 months.

(f) The apprenticeship program supplying apprentices to the area of the site of the public work shall ensure equal employment and affirmative action in apprenticeship for women and minorities.

(g) The ratio of work performed by apprentices to journeymen employed in a particular craft or trade on the public work may be no higher than the ratio stipulated in the apprenticeship standards under which the apprenticeship program operates if the contractor agrees to be bound by those standards. However, except as otherwise provided in this section, in no case shall the ratio be less than one hour of apprentice work for every five hours of journeyman work.

(h) This ratio of apprentice work to journeyman work shall apply during any day or portion of a day when any journeyman is employed at the jobsite and shall be computed on the basis of the hours worked during the day by journeymen so employed. Any work performed by a journeyman in excess of eight hours per day or 40 hours per week shall not be used to calculate the ratio. The contractor shall employ apprentices for the number of hours computed as above before the end of the contract or, in the case of a subcontractor, before the end of the

subcontract. However, the contractor shall endeavor, to the greatest extent possible, to employ apprentices during the same time period that the journeymen in the same craft or trade are employed at the jobsite. When an hourly apprenticeship ratio is not feasible for a particular craft or trade, the Administrator of Apprenticeship, upon application of an apprenticeship program, may order a minimum ratio of not less than one apprentice for each five journeymen in a craft or trade classification.

(i) A contractor covered by this section who has agreed to be covered by an apprenticeship program's standards upon the issuance of the approval certificate, or who has been previously approved for an apprenticeship program in the craft or trade, shall employ the number of apprentices or the ratio of apprentices to journeymen stipulated in the applicable apprenticeship standards, but in no event less than the 1-to-5 ratio required by subdivision (g).

(j) Upon proper showing by a contractor that he or she employs apprentices in a particular craft or trade in the state on all of his or her contracts on an annual average of not less than one hour of apprentice work for every five hours of labor performed by journeymen, the Administrator of Apprenticeship may grant a certificate exempting the contractor from the 1-to-5 hourly ratio, as set forth in this section for that craft or trade.

(k) An apprenticeship program has the discretion to grant to a participating contractor or contractor association a certificate, which shall be subject to the approval of the Administrator of Apprenticeship, exempting the contractor from the 1-to-5 ratio set forth in this section when it finds that any one of the following conditions is met:

(1) Unemployment for the previous three-month period in the area exceeds an average of 15 percent.

(2) The number of apprentices in training in the area exceeds a ratio of 1 to 5.

(3) There is a showing that the apprenticeable craft or trade is replacing at least one-thirtieth of its journeymen annually through apprenticeship training, either on a statewide basis or on a local basis.

(4) Assignment of an apprentice to any work performed under a public works contract would create a condition that would jeopardize his or her life or the life, safety, or property of fellow employees or the public at large, or the specific task to which the apprentice is to be assigned is of a nature that training cannot be provided by a journeyman.

(l) If an exemption is granted pursuant to subdivision (k) to an organization that represents contractors in a specific trade from the 1-to-5 ratio on a local or statewide basis, the member contractors shall not be required to submit individual applications for approval to local joint apprenticeship committees, if they are already covered by the local apprenticeship standards.

(m) (1) A contractor to whom a contract is awarded, who, in performing any of the work under the contract, employs journeymen or apprentices in any apprenticeable craft or trade shall contribute to the California Apprenticeship Council the same amount that the director determines is the prevailing amount of apprenticeship training contributions in the area of the public works site. A contractor may take as a credit for payments to the council any amounts paid by the contractor to an approved apprenticeship program that can supply apprentices to the site of the public works project. The contractor may add the amount of the contributions in computing his or her bid for the contract.

(2) (A) At the conclusion of the 2002-03 fiscal year and each fiscal year thereafter, the California Apprenticeship Council shall distribute training contributions received by the council under this subdivision, less the expenses of the Department of Industrial Relations for administering this subdivision, by making grants to approved apprenticeship programs for the purpose of training apprentices. The grant funds shall be distributed as follows:

(i) If there is an approved multiemployer apprenticeship program serving the same craft or trade and geographic area for which the training contributions were made to the council, a grant to that program shall be made.

(ii) If there are two or more approved multiemployer apprenticeship programs serving the same craft or trade and county for which the training contributions were made to the council, the grant shall be divided among those programs based on the number of apprentices from that county registered in each program.

(iii) All training contributions not distributed under clauses (i) and (ii) shall be used to defray the future expenses of the Department of Industrial Relations for the administration and enforcement of apprenticeship and preapprenticeship standards and requirements under this code.

(B) An apprenticeship program shall only be eligible to receive grant funds pursuant to this subdivision if the apprenticeship program agrees, prior to the receipt of any grant funds, to keep adequate records that document the expenditure of grant funds and to make all records available to the Department of Industrial Relations so that the Department of Industrial Relations is able to verify that grant funds were used solely for

training apprentices. For purposes of this subparagraph, adequate records include, but are not limited to, invoices, receipts, and canceled checks that account for the expenditure of grant funds. This subparagraph shall not be deemed to require an apprenticeship program to provide the Department of Industrial Relations with more documentation than is necessary to verify the appropriate expenditure of grant funds made pursuant to this subdivision.

(C) The Department of Industrial Relations shall verify that grants made pursuant to this subdivision are used solely to fund training apprentices. If an apprenticeship program is unable to demonstrate how grant funds are expended or if an apprenticeship program is found to be using grant funds for purposes other than training apprentices, then the apprenticeship program shall not be eligible to receive any future grant pursuant to this subdivision and the Department of Industrial Relations may initiate the process to rescind the registration of the apprenticeship program.

(3) All training contributions received pursuant to this subdivision shall be deposited in the Apprenticeship Training Contribution Fund, which is hereby created in the State Treasury. Upon appropriation by the Legislature, all moneys in the Apprenticeship Training Contribution Fund shall be used for the purpose of carrying out this subdivision and to pay the expenses of the Department of Industrial Relations.

(n) The body awarding the contract shall cause to be inserted in the contract stipulations to effectuate this section. The stipulations shall fix the responsibility of compliance with this section for all apprenticeable occupations with the prime contractor.

(o) This section does not apply to contracts of general contractors or to contracts of specialty contractors not bidding for work through a general or prime contractor when the contracts of general contractors or those specialty contractors involve less than thirty thousand dollars (\$30,000).

(p) An awarding body that implements an approved labor compliance program in accordance with subdivision (b) of Section 1771.5 may, with the approval of the director, assist in the enforcement of this section under the terms and conditions prescribed by the director.

(Amended by Stats. 2018, Ch. 704, Sec. 17. (AB 235) Effective September 22, 2018.)

1777.6. An employer or a labor union shall not refuse to accept otherwise qualified employees as registered apprentices on any public works on any basis listed in subdivision (a) of Section 12940 of the Government Code, as those bases are defined in Sections 12926 and 12926.1 of the Government Code, except as provided in Section 3077 of this code and Section 12940 of the Government Code.

(Amended by Stats. 2004, Ch. 788, Sec. 15. Effective January 1, 2005.)

1777.7. (a) (1) If the Labor Commissioner or his or her designee determines after an investigation that a contractor or subcontractor knowingly violated Section 1777.5, the contractor and any subcontractor responsible for the violation shall forfeit, as a civil penalty to the state or political subdivision on whose behalf the contract is made or awarded, not more than one hundred dollars (\$100) for each full calendar day of noncompliance. The amount of this penalty may be reduced by the Labor Commissioner if the amount of the penalty would be disproportionate to the severity of the violation. A contractor or subcontractor that knowingly commits a second or subsequent violation within a three-year period, if the noncompliance results in apprenticeship training not being provided as required by this chapter, shall forfeit as a civil penalty the sum of not more than three hundred dollars (\$300) for each full calendar day of noncompliance.

(2) In lieu of the penalty provided for in this subdivision, the Labor Commissioner may, for a first-time violation and with the concurrence of an apprenticeship program described in subdivision (d) of Section 1777.5, order the contractor or subcontractor to provide apprentice employment equivalent to the work hours that would have been provided for apprentices during the period of noncompliance.

(b) The Labor Commissioner shall consider, in setting the amount of a monetary penalty, all of the following circumstances:

- (1) Whether the violation was intentional.
- (2) Whether the party has committed other violations of Section 1777.5.
- (3) Whether, upon notice of the violation, the party took steps to voluntarily remedy the violation.
- (4) Whether, and to what extent, the violation resulted in lost training opportunities for apprentices.
- (5) Whether, and to what extent, the violation otherwise harmed apprentices or apprenticeship programs.

(c) (1) The Labor Commissioner or his or her designee shall issue a civil wage and penalty assessment, in accordance with the provisions of Section 1741, upon determination of penalties assessed under subdivisions (a) and (b). Review of a civil wage and penalty assessment issued under this subdivision may be requested in accordance with the provisions of Section 1742. The regulations of the Director of Industrial Relations, which govern proceedings for review of civil wage and penalty assessments and the withholding of contract payments under Article 1 (commencing with Section 1720) and Article 2 (commencing with Section 1770), shall apply.

(2) For purposes of this section, a determination issued pursuant to subdivision (a) or (b) includes a determination that has been approved by the Labor Commissioner and issued by an awarding body that has been authorized to assist the director in the enforcement of Section 1777.5 pursuant to subdivision (p) of that section. The Labor Commissioner may intervene in any proceeding for review of a determination issued by an awarding body. If the involvement of the Labor Commissioner in a labor compliance program enforcement action is limited to a review of the determination and the matter is resolved without litigation by or against the Labor Commissioner or the department, the awarding body shall enforce any applicable penalties, as specified in this section, and shall deposit any penalties and forfeitures collected in the General Fund.

(d) The determination of the Labor Commissioner as to the amount of the penalty imposed under subdivisions (a) and (b) shall be reviewable only for an abuse of discretion.

(e) If a subcontractor is found to have violated Section 1777.5, the prime contractor of the project is not liable for any penalties under subdivision (a) unless the prime contractor had knowledge of the subcontractor's failure to comply with the provisions of Section 1777.5 or unless the prime contractor fails to comply with any of the following requirements:

(1) The contract executed between the contractor and the subcontractor for the performance of work on the public works project shall include a copy of the provisions of Sections 1771, 1775, 1776, 1777.5, 1813, and 1815.

(2) The contractor shall continually monitor a subcontractor's use of apprentices required to be employed on the public works project pursuant to subdivision (d) of Section 1777.5, including, but not limited to, periodic review of the certified payroll of the subcontractor.

(3) Upon becoming aware of a failure of the subcontractor to employ the required number of apprentices, the contractor shall take corrective action, including, but not limited to, retaining funds due to the subcontractor for work performed on the public works project until the failure is corrected.

(4) Prior to making the final payment to the subcontractor for work performed on the public works project, the contractor shall obtain a declaration signed under penalty of perjury from the subcontractor that the subcontractor has employed the required number of apprentices on the public works project.

(f) The Division of Labor Standards Enforcement shall notify the contractor on a public works project within 15 days of the receipt by the division of a complaint that a subcontractor on that public works project knowingly violated Section 1777.5.

(g) The interpretation of Section 1777.5 and the substantive requirements of this section applicable to contractors or subcontractors shall be in accordance with the regulations of the California Apprenticeship Council.

(h) The Director of Industrial Relations may adopt regulations to establish guidelines for the imposition of monetary penalties.

(Repealed and added by Stats. 2014, Ch. 297, Sec. 3. (AB 2744) Effective January 1, 2015.)

1778. Every person, who individually or as a representative of an awarding or public body or officer, or as a contractor or subcontractor doing public work, or agent or officer thereof, who takes, receives, or conspires with another to take or receive, for his or her own use or the use of any other person any portion of the wages of any worker or working subcontractor, in connection with services rendered upon any public work is guilty of a felony.

(Amended by Stats. 2017, Ch. 28, Sec. 23. (SB 96) Effective June 27, 2017.)

1779. Any person or agent or officer thereof who charges, collects, or attempts to charge or collect, directly or indirectly, a fee or valuable consideration for registering any person for public work, or for giving information as to where such employment may be procured, or for placing, assisting in placing, or attempting to place, any person in public work, whether the person is to work directly for the State, or any political subdivision or for a contractor or subcontractor doing public work is guilty of a misdemeanor.

(Enacted by Stats. 1937, Ch. 90.)

1780. Any person acting on behalf of the State or any political subdivision, or any contractor or subcontractor or agent or representative thereof, doing any public work who places any order for the employment of a worker on public work where the filling of the order for employment involves the charging of a fee, or the receiving of a valuable consideration from any applicant for employment is guilty of a misdemeanor.

(Amended by Stats. 2017, Ch. 28, Sec. 24. (SB 96) Effective June 27, 2017.)

1781. (a) (1) Notwithstanding any other provision of law, a contractor may, subject to paragraphs (2) and (3), bring an action in a court of competent jurisdiction to recover from the body awarding a contract for a public work or otherwise undertaking any public work any increased costs incurred by the contractor as a result of any decision by the body, the Department of Industrial Relations, or a court that classifies, after the time at which the body accepts the contractor's bid or awards the contractor a contract in circumstances where no bid is solicited, the work covered by the bid or contract as a "public work," as defined in this chapter, to which Section 1771 applies, if that body, before the bid opening or awarding of the contract, failed to identify as a "public work," as defined in this chapter, in the bid specification or in the contract documents that portion of the work that the decision classifies as a "public work."

(2) The body awarding a contract for a public work or otherwise undertaking any public work is not liable for increased costs in an action described in paragraph (1) if all of the following conditions are met:

(A) The contractor did not directly submit a bid to, or directly contract with, that body.

(B) The body stated in the contract, agreement, ordinance, or other written arrangement by which it undertook the public work that the work described in paragraph (1) was a "public work," as defined in this chapter, to which Section 1771 applies, and obligated the party with whom the body makes its written arrangement to cause the work described in paragraph (1) to be performed as a "public work."

(C) The body fulfilled all of its duties, if any, under the Civil Code or any other provision of law pertaining to the body providing and maintaining bonds to secure the payment of contractors, including the payment of wages to workers performing the work described in paragraph (1).

(3) If a contractor did not directly submit a bid to, or directly contract with a body awarding a contract for, or otherwise undertaking a public work, the liability of that body in an action commenced by the contractor under subdivision (a) is limited to that portion of a judgment, obtained by that contractor against the body that solicited the contractor's bid or awarded the contract to the contractor, that the contractor is unable to satisfy. For purposes of this paragraph, a contractor may not be deemed to be unable to satisfy any portion of a judgment unless, in addition to other collection measures, the contractor has made a good faith attempt to collect that portion of the judgment against a surety bond, guarantee, or some other form of assurance.

(b) When construction has not commenced at the time a final decision by the Department of Industrial Relations or a court classifies all or part of the work covered by the bid or contract as a "public work," as defined in this chapter, the body that solicited the bid or awarded the contract shall rebid the "public work" covered by the contract as a "public work," any bid that was submitted and any contract that was executed for this work are null and void, and the contractor may not be compensated for any nonconstruction work already performed unless the body soliciting the bid or awarding the contract has agreed to compensate the contractor for this work.

(c) For purposes of this section:

(1) "Awarding body" does not include the Department of General Services, the Department of Transportation, or the Department of Water Resources.

(2) "Increased costs" includes, but is not limited to:

(A) Labor cost increases required to be paid to workers who perform or performed work on the "public work" as a result of the events described in subdivision (a).

(B) Penalties for a violation of this article for which the contractor is liable, and which violation is the result of the events described in subdivision (a).

(Added by Stats. 2003, Ch. 804, Sec. 2. Effective January 1, 2004.)

1782. (a) A charter city shall not receive or use state funding or financial assistance for a construction project if the city has a charter provision or ordinance that authorizes a contractor to not comply with the provisions of this article on any public works contract.

(b) A charter city shall not receive or use state funding or financial assistance for a construction project if the city has awarded, within the prior two years, a public works contract without requiring the contractor to comply with all of the provisions of this article. This subdivision shall not apply if the charter city's failure to include the prevailing wage or apprenticeship requirement in a particular contract was inadvertent and contrary to a city charter provision or ordinance that otherwise requires compliance with this article.

(c) A charter city is not disqualified by subdivision (a) from receiving or using state funding or financial assistance for its construction projects if the charter city has a local prevailing wage ordinance for all its public works contracts that includes requirements that in all respects are equal to or greater than the requirements imposed by the provisions of this article and that do not authorize a contractor to not comply with this article.

(d) For purposes of this section, the following shall apply:

(1) A public works contract does not include contracts for projects of twenty-five thousand dollars (\$25,000) or less when the project is for construction work, or projects of fifteen thousand dollars (\$15,000) or less when the project is for alteration, demolition, repair, or maintenance work.

(2) A charter city includes any agency of a charter city and any entity controlled by a charter city whose contracts would be subject to this article.

(3) A "construction project" means a project that involves the award of a public works contract.

(4) State funding or financial assistance includes direct state funding, state loans and loan guarantees, state tax credits, and any other type of state financial support for a construction project. State funding or financial assistance does not include revenues that charter cities are entitled to receive without conditions under the California Constitution.

(e) The Director of Industrial Relations shall maintain a list of charter cities that may receive and use state funding or financial assistance for their construction projects.

(f) (1) This section does not restrict a charter city from receiving or using state funding or financial assistance that was awarded to the city prior to January 1, 2015, or from receiving or using state funding or financial assistance to complete a contract that was awarded prior to January 1, 2015.

(2) A charter city is not disqualified by subdivision (b) from receiving or using state funding or financial assistance for its construction projects based on the city's failure to require a contractor to comply with this article in performing a contract the city advertised for bid or awarded prior to January 1, 2015.

(Added by Stats. 2013, Ch. 794, Sec. 2. (SB 7) Effective January 1, 2014.)

1784. (a) Notwithstanding any other law, a contractor may bring an action in a court of competent jurisdiction to recover from the hiring party that the contractor directly contracts with, any increased costs attributable solely to the provisions of this chapter, including, but not limited to, the difference between the wages actually paid to an employee and the wages that were required to be paid to an employee under this chapter, any penalties or other sums required to be paid under this chapter, and costs and attorney's fees for the action incurred by the contractor as a result of any decision by the Department of Industrial Relations, the Labor and Workforce Development Agency, or a court that classifies, after the time at which the hiring party accepts the contractor's bid, awards the contractor a contract under circumstances when no bid is solicited, or otherwise allows construction by the contractor to proceed, the work covered by the project, or any portion thereof, as a "public work," as defined in this chapter, except to the extent that either of the following is true:

(1) The owner or developer or its agent expressly advised the contractor that the work to be covered by the contract would be a "public work," as defined in this chapter, or is otherwise subject to the payment of prevailing wages.

(2) The hiring party expressly advised the contractor that the work subject to the contract would be a "public work," as defined in this chapter, or is otherwise subject to the payment of prevailing wages.

(b) (1) To be entitled to the recovery of increased costs described in subdivision (a), the contractor shall notify the hiring party and the owner or developer within 30 days after receipt of the notice of a decision by the Department of Industrial Relations or the Labor and Workforce Development Agency, or the initiation of any action in a court alleging, that the work covered by the project, or any portion thereof, is a "public work," as defined in this chapter.

(2) The notice provided pursuant to this subdivision shall set forth the legal name, address, and telephone number of the contractor, and the name, address, and telephone number of the contractor's representative, if

any, and shall be given by registered or certified mail, express mail, or overnight delivery by an express service carrier.

(c) A contractor is not required to list any prevailing wages or apprenticeship standard violations on a prequalification questionnaire that are the direct result of the failure of the owner or developer or its agent, or a hiring party, to notify the contractor that the project, or any portion thereof, was a "public work," as defined in this chapter.

(d) This section does not apply to private residential projects built on private property unless the project is built pursuant to an agreement with a state agency, redevelopment agency, or local public housing authority.

(e) This section does not apply if the conduct of the contractor caused the project to be a "public work," as defined in this chapter, or if the contractor has actual knowledge that the work is a "public work," as defined in this chapter.

(f) A contractor may seek recovery pursuant to this section only from a hiring party with whom the contractor has a direct contract.

(g) For purposes of this section, "contractor" means a person or entity licensed by the Contractors' State Licensing Board that has a direct contract with the hiring party to provide services on private property or for the benefit of a private owner or developer.

(h) For purposes of this section, "hiring party" means the party that has a direct contract for services provided by the contractor who is seeking recovery pursuant to subdivision (a) on a private works project that was subsequently determined to be a public work by the Department of Industrial Relations or the Labor and Workforce Development Agency, or by the initiation of any action in a court alleging that the work covered by the project, or any portion thereof, was a public work.

(Added by Stats. 2014, Ch. 161, Sec. 1. (AB 1939) Effective January 1, 2015.)

1785. (a) The director shall establish and maintain a strategic enforcement unit focused on construction, alteration, and repair projects. The unit shall enhance the department's enforcement of this code in construction, alteration, and repair projects, including projects funded pursuant to Section 50675.1.3 of the Health and Safety Code and other publicly funded residential construction projects. The unit shall have primary responsibility for enforcement of this code in construction projects subject to Section 50675.1.3 of the Health and Safety Code. Any funds appropriated to the department for purposes of this section shall be administered and allocated by the director.

(b) The strategic enforcement unit described in subdivision (a) shall provide technical assistance to local public entities related to both of the following:

(1) Best practices for monitoring and enforcing requirements pertaining to construction, alteration, and repair projects paid for in whole or in part out of public funds, including, but not limited to, this chapter.

(2) Outreach and engagement with workers, employers, and state certified apprenticeship programs connected to construction, alteration, and repair projects.

(Added by Stats. 2021, Ch. 111, Sec. 26. (AB 140) Effective July 19, 2021.)

APPENDIX D

NOTIFICATION SIGN SPECIFICATIONS AND PLANS

MELINDA ROAD PAVEMENT REHABILITATION PROJECT START DATE - END DATE

ROADWAY AND WALKWAY REHABILITATION ALONG
MELINDA ROAD BETWEEN OLYMIAD ROAD AND SANTA
MARGARITA PARKWAY COMING SOON!

PROJECT UPDATES: 949-470-3080



MAJOR FUNDING
PROVIDED BY
MEASURE M
SALES TAX &
GAS TAX FUNDS



“Fabricate Notification Sign and Install” means as follows:

Fabricate 30"-tall x 60"-wide aluminum signs with white background, black lettering and logos bolted to 4" x 4" posts which in turn are bolted to 2" x 8" x 8' long skids such that the signs can straddle existing sidewalk and, at a minimum, provide 36" x 84" clearance for pedestrians to pass under as substantially as shown on the following pages, or as reasonably modified by the Engineer.

EXACT WORDING TO BE DETERMINED DURING PRE-CONSTRUCTION MEETING. Contractor shall provide electronic mock-up of sign for approval by the Engineer.





ALICIA & MARGUERITE
INTERSECTION WIDENING PROJECT
SEPTEMBER 2018 - MARCH 2019

DUAL LEFT-TURN LANES FROM WESTBOUND
ALICIA ONTO MARGUERITE, AND
A THIRD THROUGH LANE ON EASTBOUND
ALICIA COMING SOON

PROJECT UPDATES: 949-470-3080



MAJOR FUNDING
PROVIDED BY
MEASURE M SALES TAX &
GAS TAX FUNDS



CHANGES TO PLAN SET ARE NOTED BELOW. PLANS SHOWN HEREON SHALL REFER TO NOTES BELOW:

1. A limit line is required 5' behind the crosswalk. The location of the "Type E" modified loop replacement shall be shown 1' behind the limit line as outlined in Appendix A.
2. Construction note 4 specifies asphalt rubberized hot mix surface course (ARHM-GG-CC). The acronym shall be noted to be (ARHM-GG-C).



CITY OF MISSION VIEJO

PUBLIC WORKS DEPARTMENT



PAVEMENT REHABILITATION FOR MELINDA ROAD FROM OLYMPIAD ROAD TO SANTA MARGARITA PARKWAY

GENERAL NOTES:

ALL WORKS, MATERIALS AND EQUIPMENTS SHALL CONFORM TO CALTRANS STD. PLANS AND SPECIFICATIONS DATED 2018, THE CITY OF MISSION VIEJO STD. PLANS AND STD. SPECIFICATIONS FOR PUBLIC WORKS CONSTRUCTION, 2022 EDITION.

THE CONTRACTOR SHALL OBTAIN ALL NECESSARY PERMITS AND SHALL NOTIFY THE CITY INSPECTOR (949) 470-3058 48 HOURS PRIOR TO STARTING EACH PHASE OF CONSTRUCTION AND 24 HOURS PRIOR TO REQUIRING INSPECTION.

TRAFFIC CONTROL SAFETY DEVICES SHALL BE PROVIDED AND SHALL BE MAINTAINED PER THE WORK AREA TRAFFIC CONTROL HANDBOOK (WATCH), AND TO THE SATISFACTION OF THE ENGINEER'S REPRESENTATIVE. FOR TRAFFIC CONTROL DEVICES TO BE PLACED WITHIN THE CITY OF RANCHO SANTA MARGARITA, NOTIFY TERRY GREGORY (949) 635-1800 (EXT. 6102) AT LEAST 24 HOURS IN ADVANCE.

THE CONTRACTOR SHALL BE RESPONSIBLE FOR THE PROTECTION OF UTILITIES. ANY DAMAGE TO SUCH FACILITIES CAUSED BY HIS WORK SHALL BE REPAIRED BY THE CONTRACTOR AT HIS OWN EXPENSE.

CONTRACTOR SHALL MAINTAIN ADJACENT STREETS IN A NEAT, CLEAN, DUST FREE AND SANITARY CONDITION AT ALL TIMES AND TO THE SATISFACTION OF CITY ENGINEER. THE ADJACENT STREETS SHALL BE KEPT CLEAN OF DEBRIS, WITH DUST AND OTHER NUISANCE BEING CONTROLLED AT ALL TIMES. CONTRACTOR SHALL BE RESPONSIBLE FOR ANY CLEAN UP ON ADJACENT STREETS AFFECTED BY HIS CONSTRUCTION. THERE SHALL BE NO STOCKPILING OF MATERIALS WITHIN THE PUBLIC RIGHT-OF-WAY WITHOUT THE PERMISSION OF THE CITY'S INSPECTOR.

BY ACCEPTING THIS CONTRACT, CONTRACTOR HEREBY RELEASES AND AGREES TO INDEMNIFY, DEFEND, HOLD HARMLESS THE OWNER, ENGINEER (HEREINAFTER ARDURRA GROUP, INC.) THEIR PARENT AND SUBSIDIARY COMPANIES, AGENTS, EMPLOYEES, CONSULTANTS AND REPRESENTATIVES FOR ANY AND ALL DAMAGE TO PERSONS OR PROPERTY OR WRONGFUL DEATH REGARDLESS OF WHETHER OR NOT SUCH CLAIM, DAMAGE LOSS OR EXPENSE IS CAUSED IN WHOLE OR IN PART BY THE NEGLIGENCE, ACTIVE OR PASSIVE, OF OWNER, ENGINEER, THEIR PARENT AND SUBSIDIARY COMPANIES, AS WELL AS THEIR AGENTS AND EMPLOYEES, EXCEPTING ONLY THE SOLE NEGLIGENCE OF OWNER, ENGINEER THEIR PARENT OR SUBSIDIARY COMPANIES AND THEIR AGENTS AND EMPLOYEES TO THE FULLEST EXTENT PERMITTED BY LAW. SUCH INDEMNIFICATION SHALL EXTEND TO ALL CLAIMS, DEMANDS, ACTIONS, OR LIABILITIES FOR INJURIES, DEATH OR DAMAGES OCCURRING AFTER COMPLETION OF THE PROJECT, AS WELL AS DURING THE WORK'S PROGRESS. CONTRACTOR FURTHER AGREES THAT IT SHALL ACCOMPLISH THE ABOVE AT ITS OWN COST, EXPENSE AND RISK EXCLUSIVE OF AND REGARDLESS OF ANY APPLICABLE INSURANCE COMPANY REGARDING COVERAGE.

UNDERGROUND SERVICE ALERT OF SOUTHERN CALIFORNIA

ATTENTION IS DIRECTED TO THE POSSIBLE EXISTENCE OF UNDERGROUND FACILITIES NOT KNOWN OR IN A LOCATION DIFFERENT FROM THAT WHICH IS SHOWN ON THE PLANS OR IN THE SPECIAL PROVISIONS. THE CONTRACTOR SHALL TAKE STEPS TO ASCERTAIN THE EXACT LOCATION OF ALL UNDERGROUND FACILITIES PRIOR TO DOING WORK THAT MAY DAMAGE SUCH FACILITIES OR INTERFERE WITH THEIR SERVICE.

BEFORE EXCAVATION, THE CONTRACTOR SHALL VERIFY THE LOCATION OF UNDERGROUND UTILITIES BY CONTACTING UNDERGROUND SERVICE ALERT AT 811

UTILITY AND AGENCY INDEX:

SOUTHERN CA. GAS CO.	ED HALE	(714) 634-3118
AT&T	VICTOR PEREZ	(714) 666-5696
SOUTHERN CA. EDISON	ANDREW MACBETH	(949) 458-4618
SANTA MARGARITA W. D.	JAMIE AGUILAR	(949) 459-6582
COX COMMUNICATIONS	DON WILKERSON	(949) 546-2917
CITY OF MISSION VIEJO	MAINTENANCE DIVISION	(949) 470-3095
CITY OF RSM	TERRY GREGORY	(949) 634-1800 (x6102)

NOTICE TO CONTRACTOR

PURSUANT TO ASSEMBLY BILL 3019, NO EXCAVATION PERMIT IS VALID UNLESS THE FOLLOWING ARE PERFORMED:

UNDERGROUND SERVICE ALERT HAS BEEN CONTRACTED AND PROVIDED INQUIRY I.D. NUMBER _____

THE CONTRACTOR AGREES TO CONTACT AND OBTAIN AN INQUIRY I.D. NUMBER FROM UNDERGROUND SERVICE ALERT 811 AT LEAST TWO (2) WORKING DAYS PRIOR TO COMMENCEMENT OF EXCAVATION.

SIGNED: _____ DATE: _____

INDEX OF SHEETS

SHEET NO.	DESCRIPTION
1	TITLE SHEET
2	TYPICAL SECTIONS - DETAILS
3-5	STREET IMPROVEMENT PLAN
6-8	SIGNING AND STRIPING PLAN

LEGEND & ABBREVIATION

SSMH	-	SANITARY SEWER MANHOLE
SDMH	-	STORM DRAIN MANHOLE
TELMH	-	TELEPHONE MANHOLE
CATV	-	CABLE T.V.
S.P.	-	TRAFFIC SIGNAL POLE
P.B.	-	TRAFFIC SIGNAL/STREET LIGHT PULL BOX
E.B.	-	ELECTRICAL BOX
W.V.	-	WATER VALVE / BOX
C.B.	-	CATCH BASIN
M.H.	-	MANHOLE (NO IDENTIFICATION)
F.H.	-	FIRE HYDRANT
R/W	-	RIGHT OF WAY
E.V.	-	ELECTRICAL VAULT
MON	-	MONUMENT WELL

**CITY OF MISSION VIEJO
LOCATION MAP**

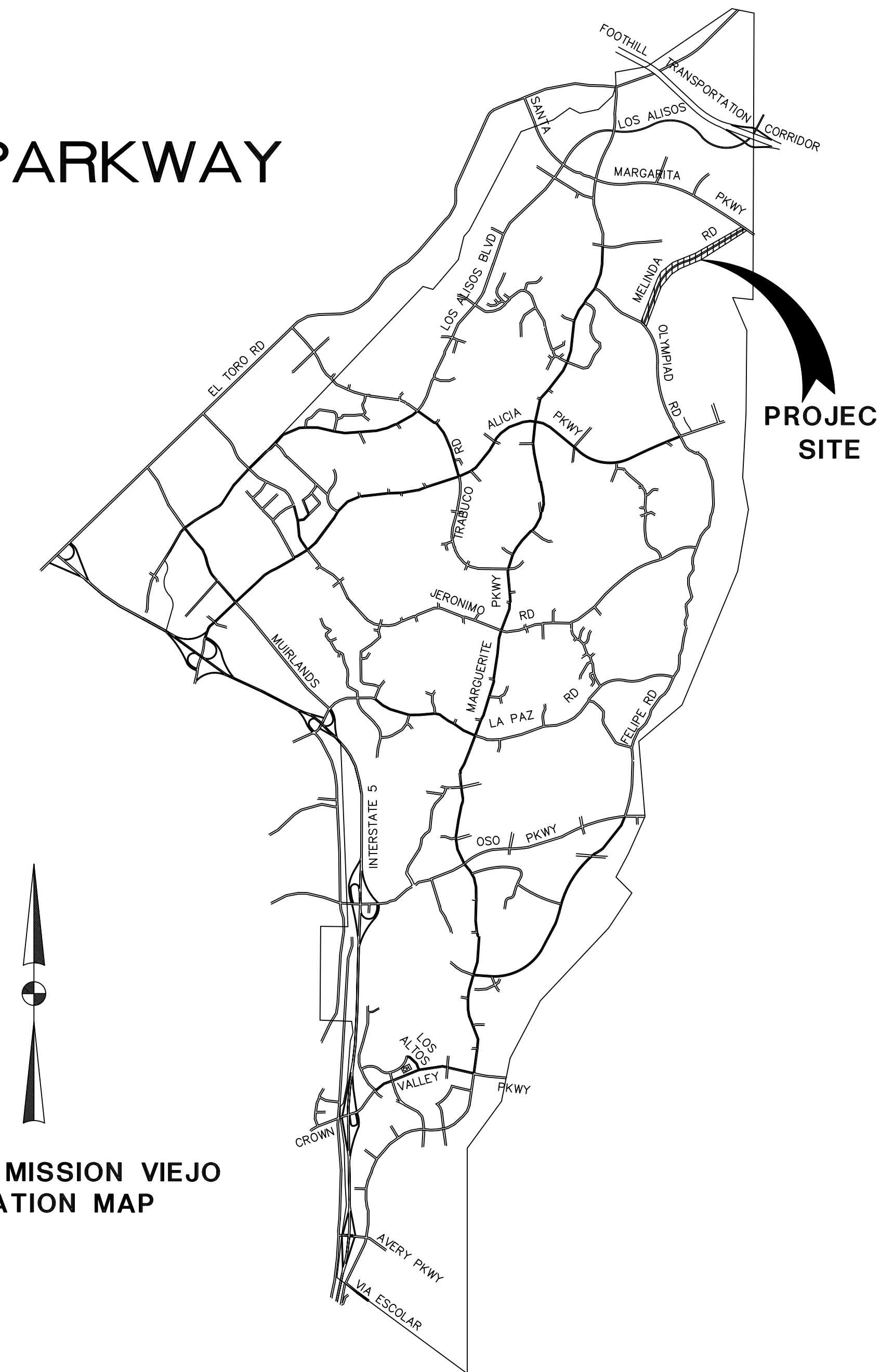

NO.	REVISIONS	RECMD'D	APPRV'D	DATE

--	--	--	--	--

3737 BIRCH ST. SUITE 250
NEWPORT BEACH, CA 92660
P: (949) 428-1500
F: (949) 258-5053

UNDER THE RESPONSIBLE CHARGE OF:

[Signature]
CIVIL ENGINEER

11/30/2022
DATE

SEAL

RECOMMENDED FOR APPROVAL:

CITY OF MISSION VIEJO
APPROVED BY:

[Signature]
CITY ENGINEER

51160 LIC.
12/1/2022 DATE

TITLE SHEET

PERMIT NO. _____

SHEET 1 OF 8

JOB NO. CIP 837

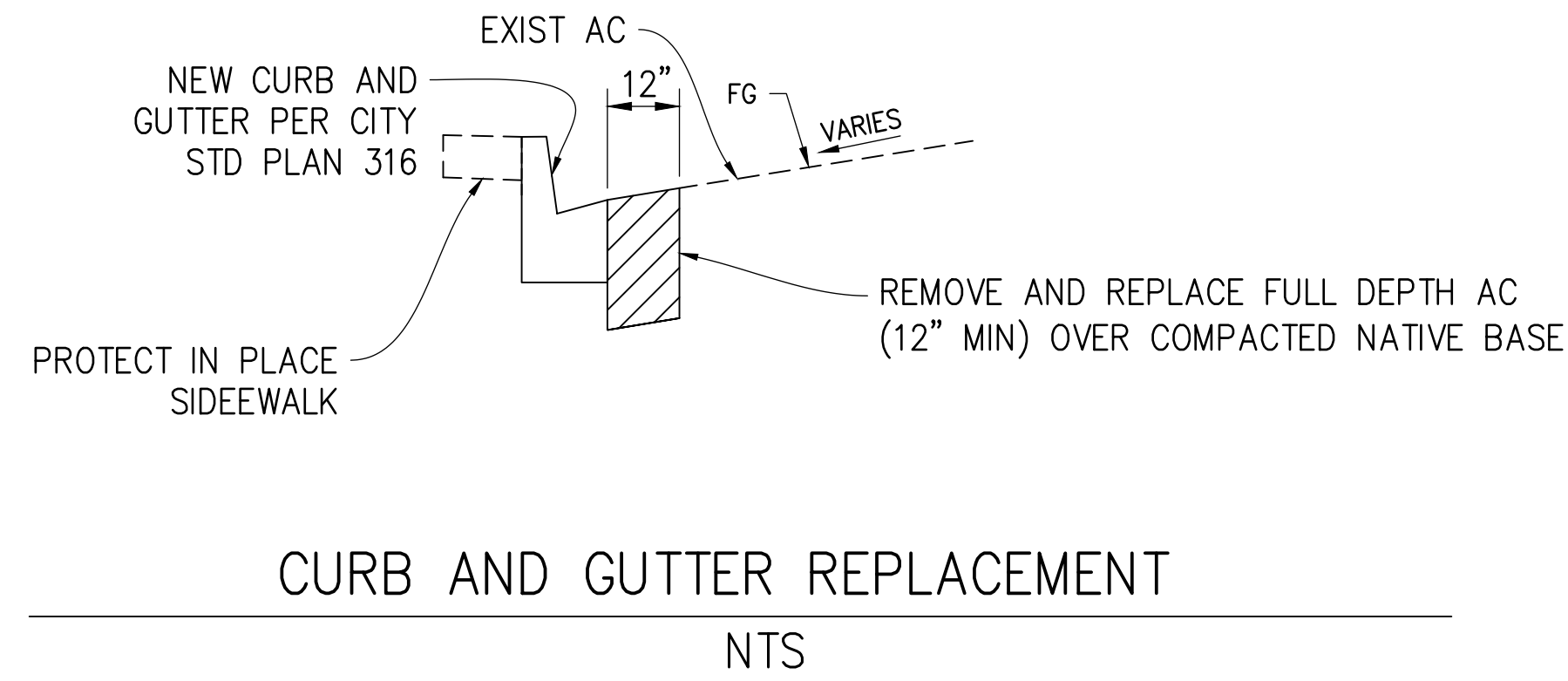
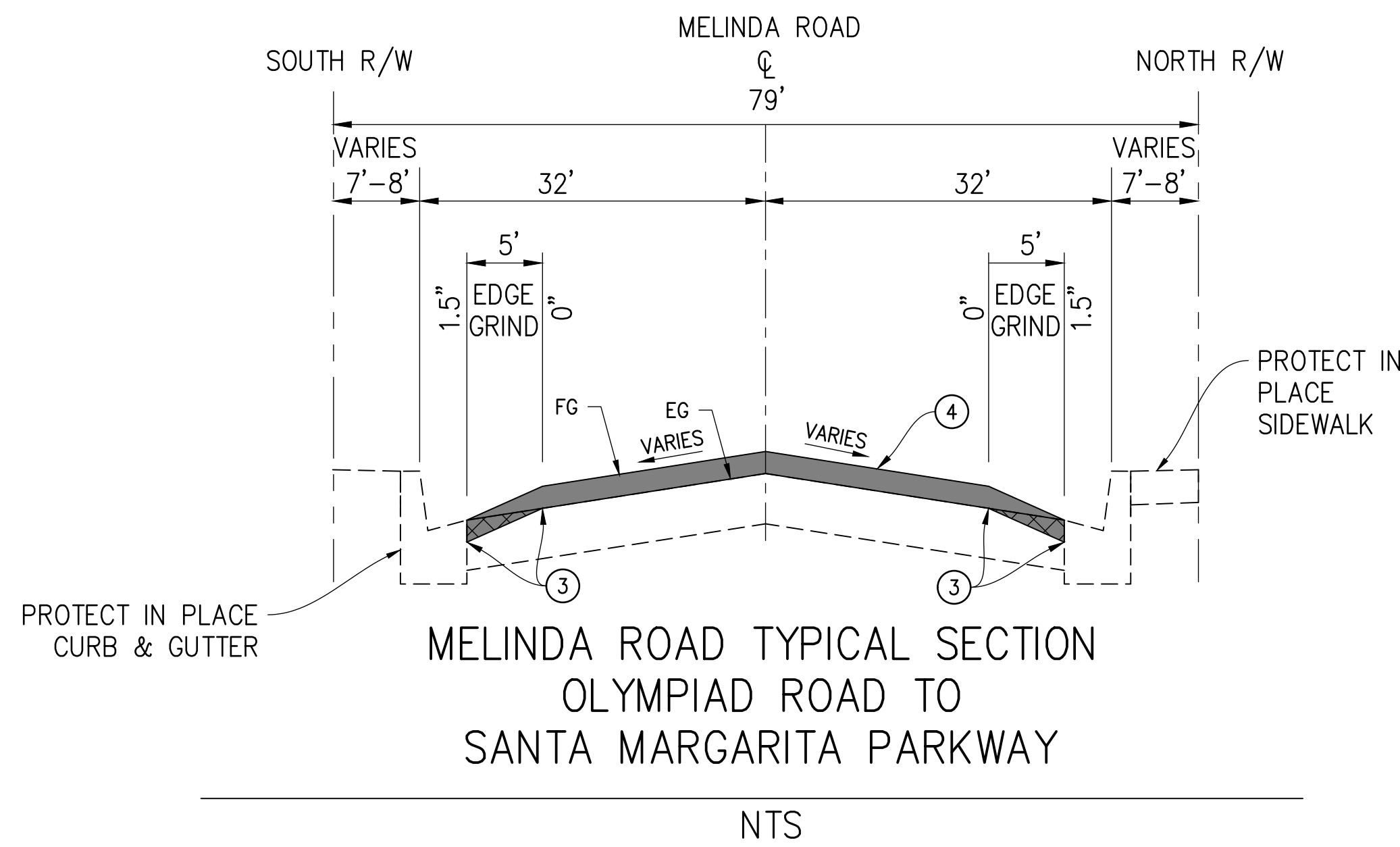

CONSTRUCTION NOTES

- ① PROTECT IN PLACE.
- ② REMOVE EXISTING AND CONSTRUCT NEW PCC CURB RAMP PER CITY OF MISSION VIEJO STD. PLAN 322 (CASE PER PLAN). SEE DETAIL ON SHT 2.
- ③ 5' WIDE EDGE GRIND, 1.5" TO 0".
- ④ CRACK SEAL AND CONSTRUCT 1.5" THICK ASPHALT RUBBER HOT MIX (ARHM-GG-CC) SURFACE COURSE.
- ⑤A DOUBLE ADJUST STORM DRAIN MANHOLE TO GRADE.
- ⑥ ADJUST WATER VALVE BOX AND FRAME COVER TO GRADE.
- ⑦ ADJUST SEWER MANHOLE TO GRADE.
- ⑧ ADJUST STORM DRAIN MANHOLE TO GRADE.
- ⑨ ADJUST WELL MONUMENT COVER TO GRADE.
- ⑩ GRIND EXISTING TO A DEPTH OF 4" AND RE-PAVE WITH 4" THICK AC BASE COURSE, TYPE B2 PG 64-10. CITY INSPECTOR TO MARK LIMITS.
- ⑪ REMOVE EXISTING PCC WALK AND CONSTRUCT NEW SIDEWALK PER CITY OF MISSION VIEJO STANDARD PLAN NO. 321. CUT AND REMOVE TREE ROOTS. CITY INSPECTOR TO MARK LIMITS.
- ⑫ REMOVE EXISTING CURB AND GUTTER AND CONSTRUCT NEW TYPE A-8 CURB AND GUTTER PER CITY OF MISSION VIEJO STANDARD PLAN NO. 316 WITH 12" WIDE AC SLOT PATCH PER DETAIL ON SHEET 2. CITY INSPECTOR TO MARK LIMITS.
- ⑬ ADJUST S.M.W.D. WATER VAULT TO GRADE.
- ⑭ ADJUST TO GRADE BY OTHERS.
- ⑮ ADJUST WATER METER BOX TO GRADE.

CONSTRUCTION LEGEND

- 1.5" ARHM OVERLAY
- EDGE GRIND EXISTING AC
- SLOT CUT AC

NOTE: SAWCUT & REMOVE EXISTING ACCESS RAMP, PORTION OF CROSS GUTTER, AND SIDEWALK (IF NECESSARY). CITY INSPECTOR WILL MARK LIMITS. CONSTRUCT NEW ACCESS RAMP AND INSTALL SURFACE-APPLIED TILE DETECTABLE WARNING DOMES WITH ADHESIVE AND FASTNERS PER PROJECT SPECIFICATIONS. SIZE AND LOCATION OF DOMES PER CITY STANDARD PLAN NO. 322. REPLACE ALL TRAFFIC SIGNAL PULL BOXES WITH 6-E BOXES.

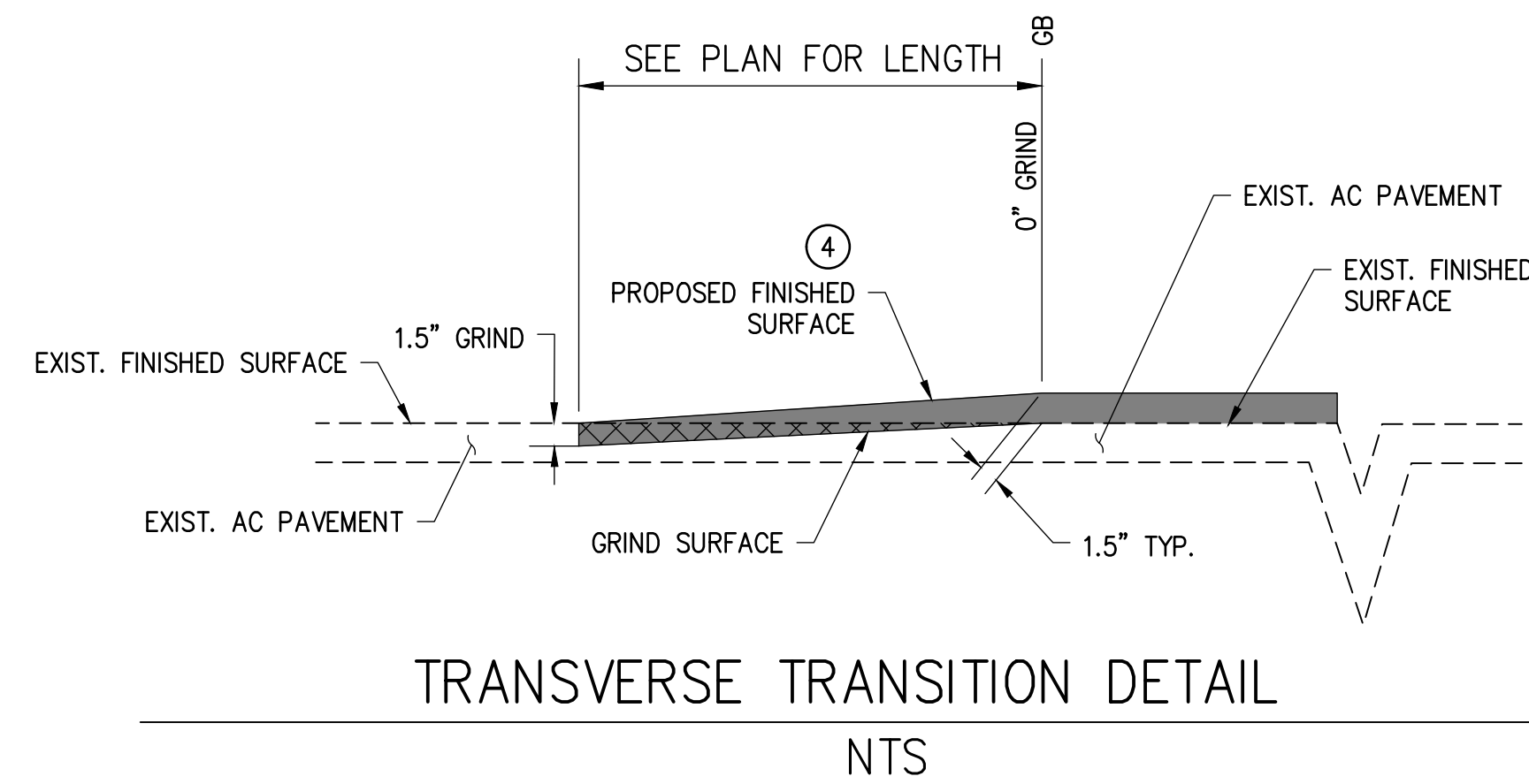
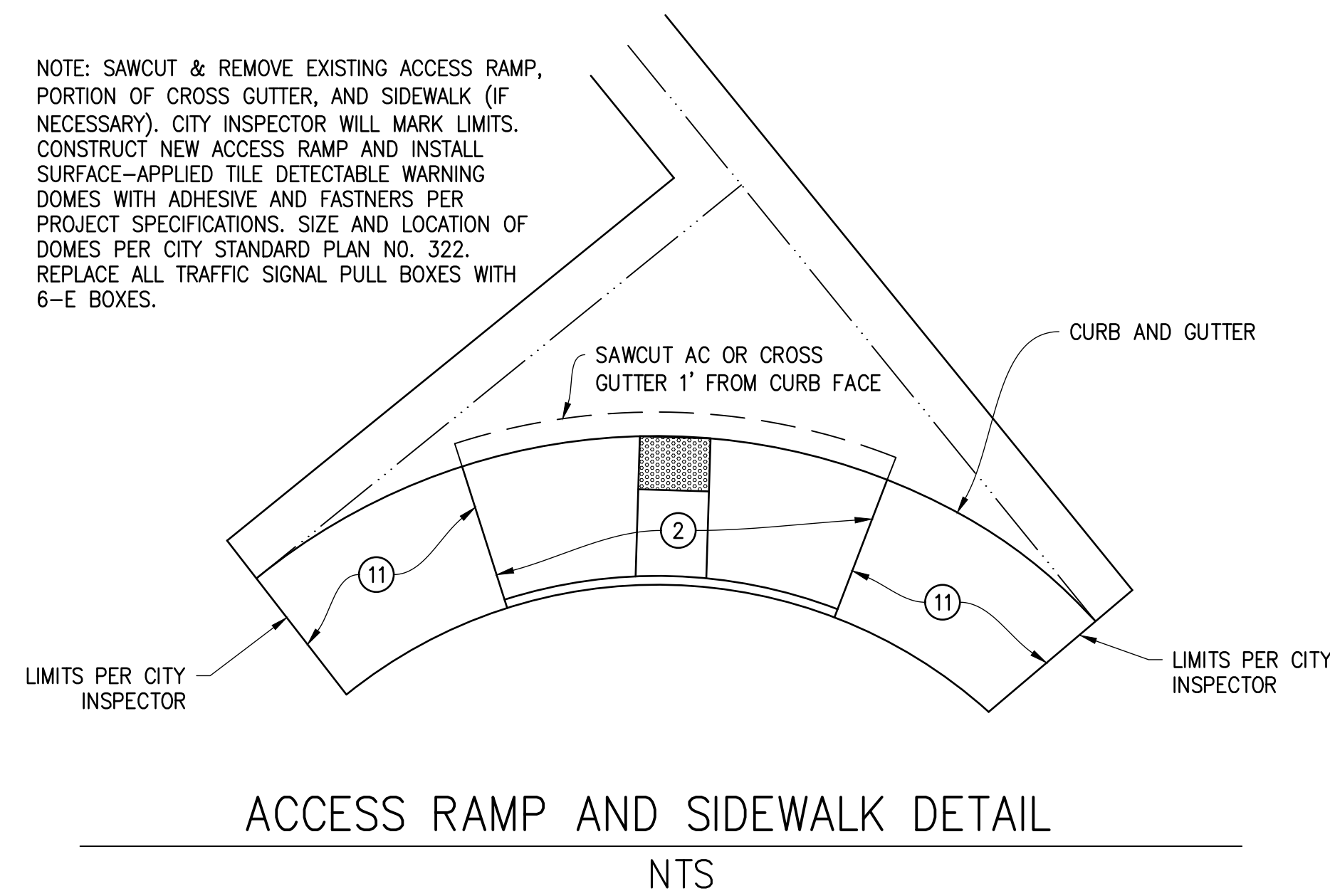

8					
7					
6					
5					
4					
3					
2					
1					
NO.	DATE	REVISIONS	APP.	DATE	

PLANS PREPARED BY:
ARDURRA
 3737 BIRCH ST. SUITE 250
 NEWPORT BEACH, CA 92660
 P: (949) 428-1500
 F: (949) 258-5053
 PREPARED UNDER THE SUPERVISION OF:
 DATE: 11/30/22
 DISBYTE BICE DATE: 12-31-05
 R.C.E. NO.: 83157 EXP.

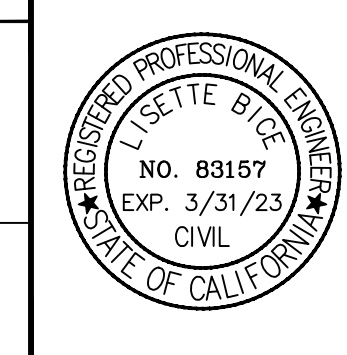

DRAWN BY: AA, KL, JS DATE: 5/18/22
 DESIGNED BY: EF, MH DATE: 5/18/22
 CHECKED BY: LB, JB DATE: 5/26/22
 RECOMMENDED BY: _____ DATE: _____

APPROVED BY: CITY ENGINEER DATE: 12/1/2022

 R.C.E. NO. 51160
 APPROVED BY: _____ DATE: _____

REFERENCE PLANS

TYPICAL SECTIONS - DETAILS
 CITY OF MISSION VIEJO
 PUBLIC WORKS DEPARTMENT

PROJECT NO. CIP 837
 SHEET 2 OF 8

OLYMPIAD ROAD

TOBARRA

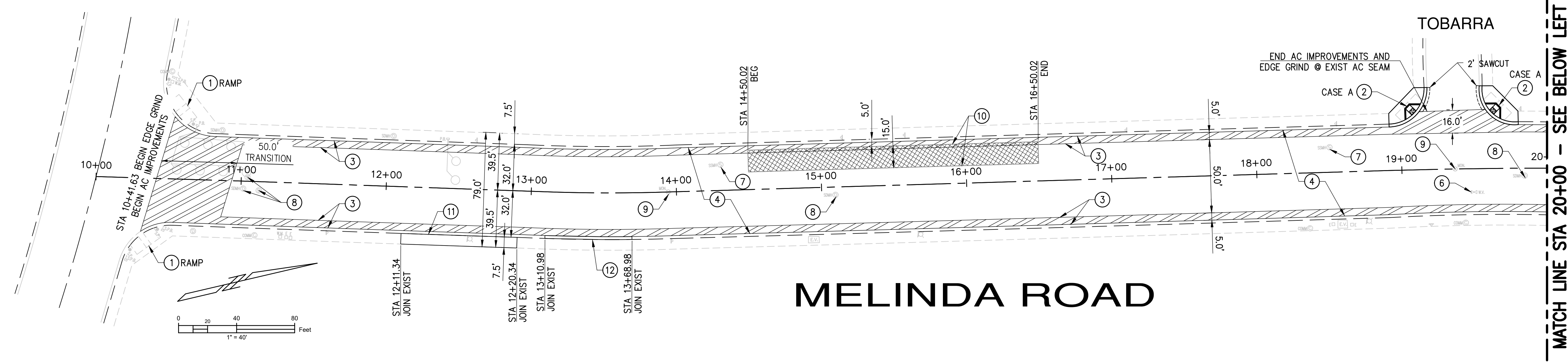

MELINDA ROAD

MATCH LINE STA 20+00 - SEE BELOW LEFT

MATCH LINE STA 20+00 - SEE ABOVE RIGHT

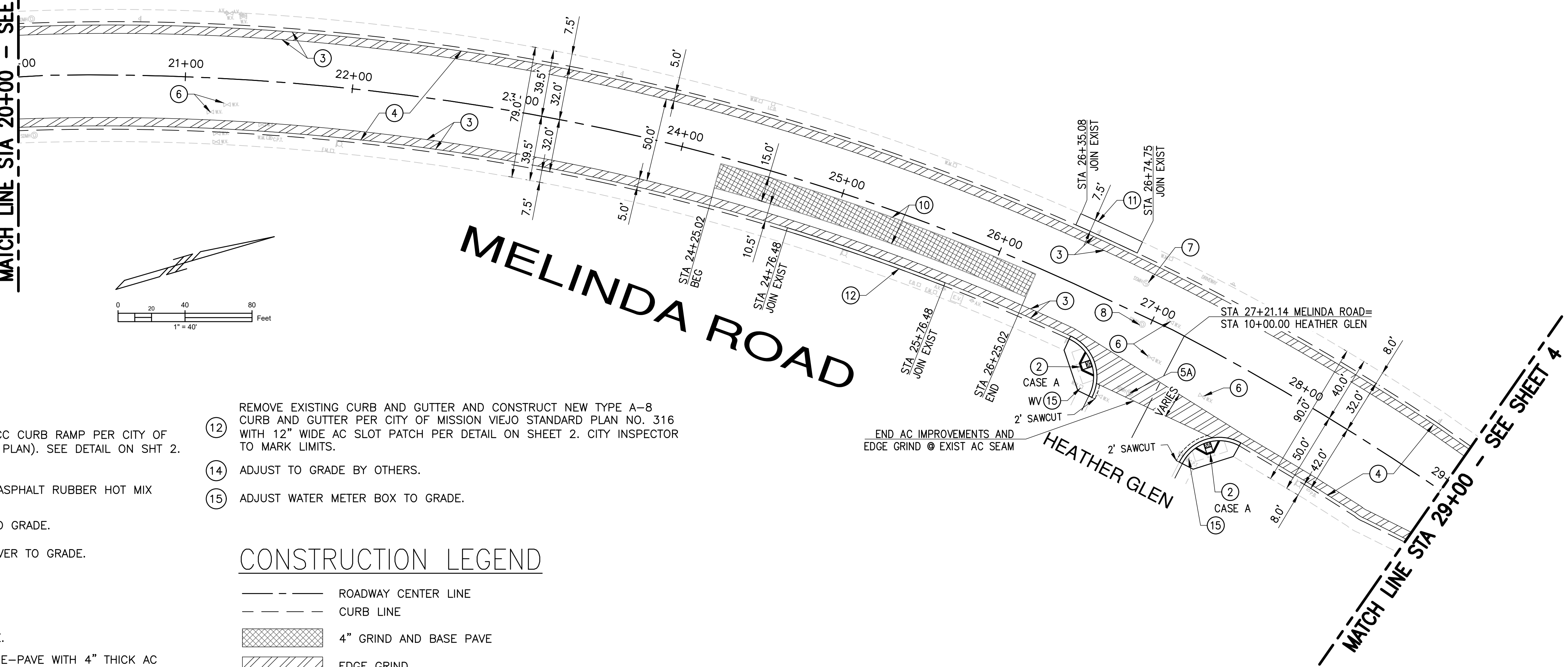

MELINDA ROAD

MATCH LINE STA 29+00 - SEE SHEET 4

CONSTRUCTION NOTES

- ① PROTECT IN PLACE.
- ② REMOVE EXISTING AND CONSTRUCT NEW PCC CURB RAMP PER CITY OF MISSION VIEJO STD. PLAN 322 (CASE PER PLAN). SEE DETAIL ON SHT 2.
- ③ 5' WIDE EDGE GRIND, 1.5" TO 0".
- ④ CRACK SEAL AND CONSTRUCT 1.5" THICK ASPHALT RUBBER HOT MIX (ARHM-GG-CC) SURFACE COURSE.
- ⑤A DOUBLE ADJUST STORM DRAIN MANHOLE TO GRADE.
- ⑥ ADJUST WATER VALVE BOX AND FRAME COVER TO GRADE.
- ⑦ ADJUST SEWER MANHOLE TO GRADE.
- ⑧ ADJUST STORM DRAIN MANHOLE TO GRADE.
- ⑨ ADJUST WELL MONUMENT COVER TO GRADE.
- ⑩ GRIND EXISTING TO A DEPTH OF 4" AND RE-PAVE WITH 4" THICK AC BASE COURSE, TYPE B2 PG 64-10. CITY INSPECTOR TO MARK LIMITS.
- ⑪ REMOVE EXISTING PCC WALK AND CONSTRUCT NEW SIDEWALK PER CITY OF MISSION VIEJO STANDARD PLAN NO. 321. CUT AND REMOVE TREE ROOTS. CITY INSPECTOR TO MARK LIMITS.

- ⑫ REMOVE EXISTING CURB AND GUTTER AND CONSTRUCT NEW TYPE A-8 CURB AND GUTTER PER CITY OF MISSION VIEJO STANDARD PLAN NO. 316 WITH 12" WIDE AC SLOT PATCH PER DETAIL ON SHEET 2. CITY INSPECTOR TO MARK LIMITS.
- ⑭ ADJUST TO GRADE BY OTHERS.
- ⑮ ADJUST WATER METER BOX TO GRADE.

CONSTRUCTION LEGEND

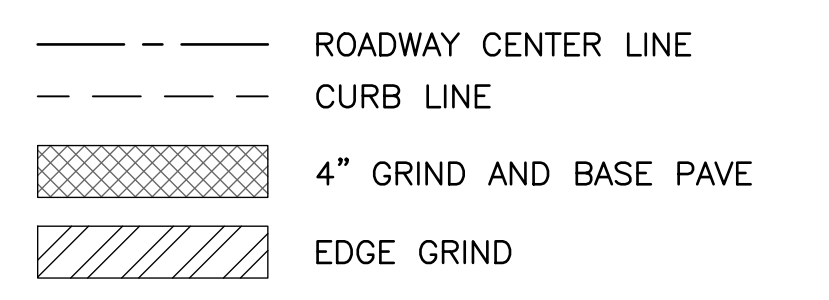

NO.	DATE	REVISIONS	APP.	DATE
8				
7				
6				
5				
4				
3				
2				
1				

PLANS PREPARED BY:

3737 BIRCH ST. SUITE 250
NEWPORT BEACH, CA 92660
P: (949) 428-1500
F: (949) 258-5053

PREPARED UNDER THE SUPERVISION OF:

DATE: 11/30/22
R.C.E. NO.: 83157 EXP. 12-31-05

DRAWN BY: AA, KL, JS DATE: 5/18/22
DESIGNED BY: EF, MH DATE: 5/18/22
CHECKED BY: LB, JB DATE: 5/26/22
RECOMMENDED BY: DATE:

APPROVED BY: CITY ENGINEER
 DATE: 12/1/2022
R.C.E. NO. 51160
APPROVED BY: DATE:

REFERENCE PLANS

STREET IMPROVEMENT PLAN
MELINDA ROAD
PAVEMENT RESURFACING
FROM OLYMPIAD ROAD TO SANTA MARGARITA PARKWAY
CITY OF MISSION VIEJO
PUBLIC WORKS DEPARTMENT

PROJECT NO. CIP 837
SHEET 3
OF 8

MATCH LINE STA 29+00 - SEE SHEET 3

MATCH LINE STA 41+00 - SEE ABOVE RIGHT

MATCH LINE STA 41+00 - SEE BELOW LEFT

MATCH LINE STA 53+00 - SEE SHEET 5

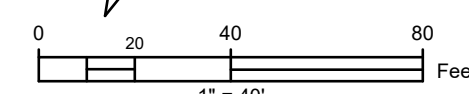
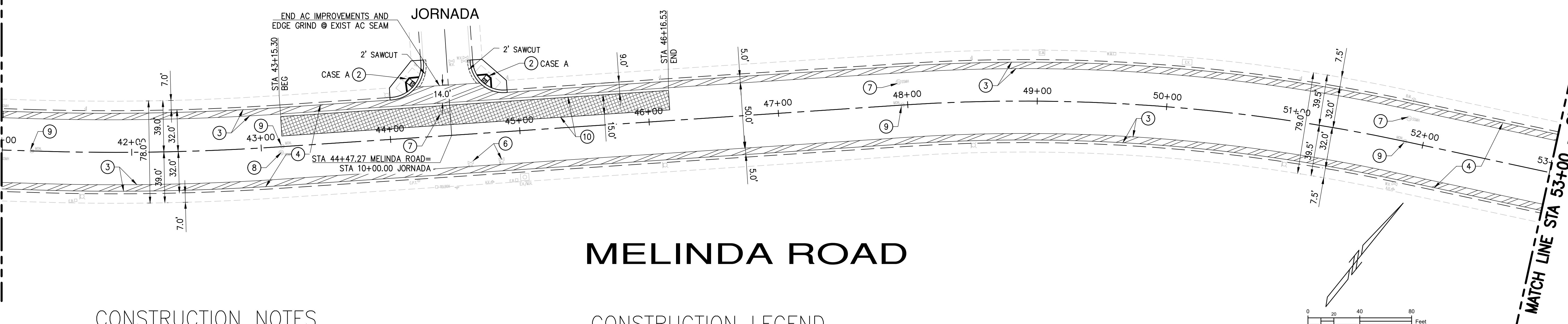
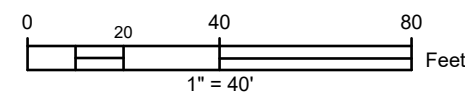
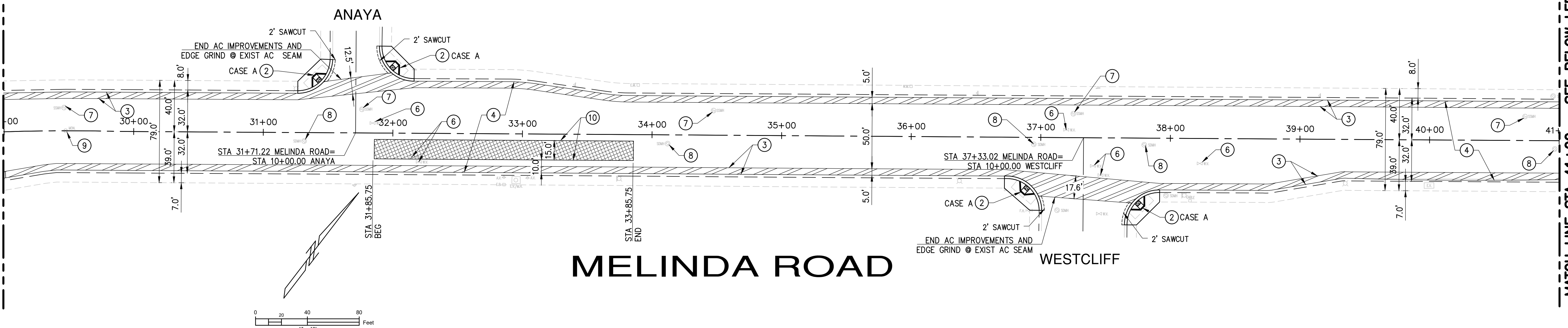

CONSTRUCTION NOTES

- ① PROTECT IN PLACE.
- ② REMOVE EXISTING AND CONSTRUCT NEW PCC CURB RAMP PER CITY OF MISSION VIEJO STD. PLAN 322 (CASE PER PLAN). SEE DETAIL ON SHT 2.
- ③ 5' WIDE EDGE GRIND, 1.5" TO 0".
- ④ CRACK SEAL AND CONSTRUCT 1.5" THICK ASPHALT RUBBER HOT MIX (ARHM-GG-CC) SURFACE COURSE.
- ⑥ ADJUST WATER VALVE BOX AND FRAME COVER TO GRADE.
- ⑦ ADJUST SEWER MANHOLE TO GRADE.
- ⑧ ADJUST STORM DRAIN MANHOLE TO GRADE.
- ⑨ ADJUST WELL MONUMENT COVER TO GRADE.
- ⑩ GRIND EXISTING TO A DEPTH OF 4" AND RE-PAVE WITH 4" THICK AC BASE COURSE, TYPE B2 PG 64-10. CITY INSPECTOR TO MARK LIMITS.

CONSTRUCTION LEGEND

- ROADWAY CENTER LINE
- - - CURB LINE
- ▨ 4" GRIND AND BASE PAVE
- ▩ EDGE GRIND

NO.	DATE	REVISIONS	APP.	DATE
8				
7				
6				
5				
4				
3				
2				
1				

PLANS PREPARED BY:

3737 BIRCH ST. SUITE 250
NEWPORT BEACH, CA 92660
P: (949) 428-1500
F: (949) 258-5053

PREPARED UNDER THE SUPERVISION OF:

DATE: 11/30/22
R.C.E. NO.: 83157 EXP. 12-31-05

DRAWN BY: AA, KL, JS DATE: 5/18/22

DESIGNED BY: EF, MH DATE: 5/18/22

CHECKED BY: LB, JB DATE: 5/26/22

RECOMMENDED BY: DATE:

APPROVED BY: CITY ENGINEER

DATE: 12/1/2022

R.C.E. NO. 51160

APPROVED BY: DATE:

REFERENCE PLANS

STREET IMPROVEMENT PLAN
MELINDA ROAD
PAVEMENT RESURFACING
FROM OLYMPIAD ROAD TO SANTA MARGARITA PARKWAY

CITY OF MISSION VIEJO
PUBLIC WORKS DEPARTMENT

PROJECT NO.
CIP 837

SHEET 4
OF 8

MATCH LINE STA 53+00 - SEE SHEET 4

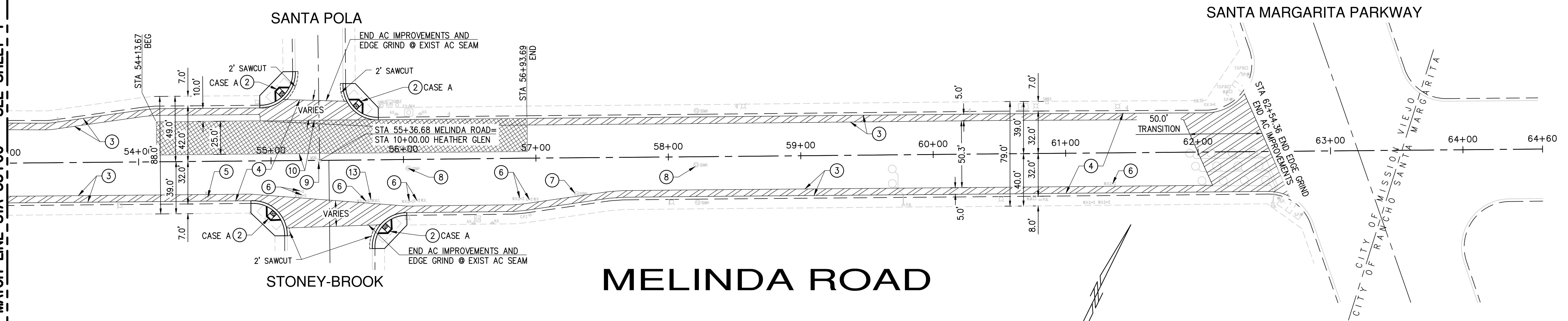

MELINDA ROAD

CONSTRUCTION NOTES

- ② REMOVE EXISTING AND CONSTRUCT NEW PCC CURB RAMP PER CITY OF MISSION VIEJO STD. PLAN 322 (CASE PER PLAN). SEE DETAIL ON SHT 2.
- ③ 5' WIDE EDGE GRIND, 1.5" TO 0".
- ④ CRACK SEAL AND CONSTRUCT 1.5" THICK ASPHALT RUBBER HOT MIX (ARHM-GG-CC) SURFACE COURSE.
- ⑤ DOUBLE ADJUST WATER VALVE TO GRADE.
- ⑥ ADJUST WATER VALVE BOX AND FRAME COVER TO GRADE.
- ⑦ ADJUST SEWER MANHOLE TO GRADE.
- ⑧ ADJUST STORM DRAIN MANHOLE TO GRADE.
- ⑨ ADJUST WELL MONUMENT COVER TO GRADE.
- ⑩ GRIND EXISTING TO A DEPTH OF 4" AND RE-PAVE WITH 4" THICK AC BASE COURSE, TYPE B2 PG 64-10. CITY INSPECTOR TO MARK LIMITS.
- ⑬ ADJUST S.M.W.D. WATER VAULT TO GRADE.

CONSTRUCTION LEGEND

- ROADWAY CENTER LINE
- - - CURB LINE
- ▨ 4" GRIND AND BASE PAVE
- ▩ EDGE GRIND

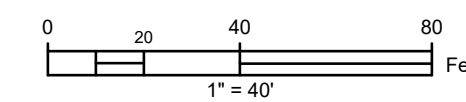

8					
7					
6					
5					
4					
3					
2					
1					
NO.	DATE	REVISIONS	APP.	DATE	

PLANS PREPARED BY:

 3737 BIRCH ST. SUITE 250
 NEWPORT BEACH, CA 92660
 P: (949) 428-1500
 F: (949) 258-5053

PREPARED UNDER THE SUPERVISION OF:

 DATE: 11/30/22
 DISETTE BICE
 R.C.E. NO.: 83157

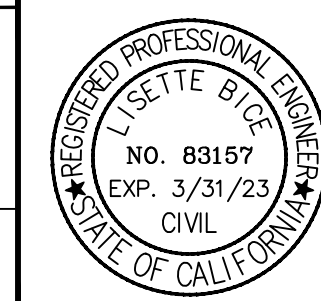

DRAWN BY: AA, KL, JS DATE: 5/18/22
 DESIGNED BY: EF, MH DATE: 5/18/22
 CHECKED BY: LB, JB DATE: 5/26/22
 RECOMMENDED BY: DATE:

APPROVED BY: CITY ENGINEER

 DATE: 12/1/2022
 R.C.E. NO. 51160
 APPROVED BY: DATE:

REFERENCE PLANS

STREET IMPROVEMENT PLAN
 MELINDA ROAD
 PAVEMENT RESURFACING
 FROM OLYMPIAD ROAD TO SANTA MARGARITA PARKWAY
 CITY OF MISSION VIEJO
 PUBLIC WORKS DEPARTMENT

PROJECT NO.
 CIP 837
 SHEET 5
 OF 8

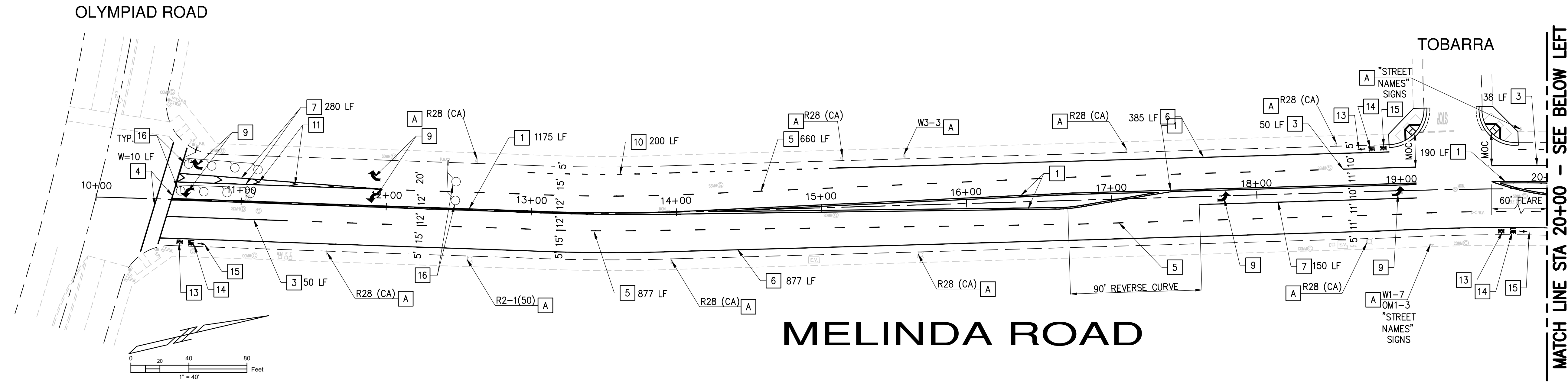

MATCH LINE STA 20+00 - SEE BELOW LEFT

STRIPING NOTES

- A PROTECT IN PLACE EXISTING SIGN AND POST
- 1 INSTALL DOUBLE YELLOW PER CALTRANS STD. PLAN A20A, DETAIL 22.
- 3 INSTALL 4" WIDE SOLID WHITE LINE AT INTERSECTION AS SHOWN WITH TYPE G MARKER AT EACH END.
- 4 INSTALL BASIC CROSSWALK PER CALTRANS STD. PLAN A24F.
- 5 INSTALL WHITE LANE LINE PER CALTRANS STD. PLAN A20A, DETAIL 9.
- 6 INSTALL SOLID WHITE LINE PER CALTRANS STD. PLAN A20D, DETAIL 39.
- 7 INSTALL SOLID WHITE CHANNELIZING LINE PER CALTRANS STD. PLAN A20D, DETAIL 38.
- 9 INSTALL WHITE TYPE IV LEFT/RIGHT TURN ARROW PER CALTRANS STD. PLAN A24A.
- 10 INSTALL WHITE DASHED LINE PER CALTRANS STD. PLAN A20D, DETAIL 39A.
- 11 INSTALL 12" SOLID WHITE CHEVRON MARKING AT 10' SPACING CENTER TO CENTER
- 12 INSTALL WHITE TYPE VI ARROW PER CALTRANS STD. PLAN A24A.
- 13 INSTALL "BIKE" PAVEMENT MARKING WORD PER CALTRANS STD. PLAN 24D.
- 14 INSTALL "LANE" PAVEMENT MARKING WORD PER CALTRANS STD. PLAN 24D.
- 15 INSTALL BIKE LANE ARROW PAVEMENT MARKING PER CALTRANS STD. PLAN 24A.
- 16 CONTRACTOR SHALL REPLACE ALL EXISTING LOOPS WITH TYPE "E" OR MODIFIED TYPE "E" LOOP DETECTOR PER CALTRANS STD. PLAN RSP ES-5B AND SPLICE TO DLC IN ADJACENT PULLBOX AS SHOWN ON PLAN. LOOPS SHALL BE CENTERED IN LANES WITH 10' SPACING IN THE DIRECTION OF TRAVEL AND LOCATED 1' PRIOR TO CROSSWALK.

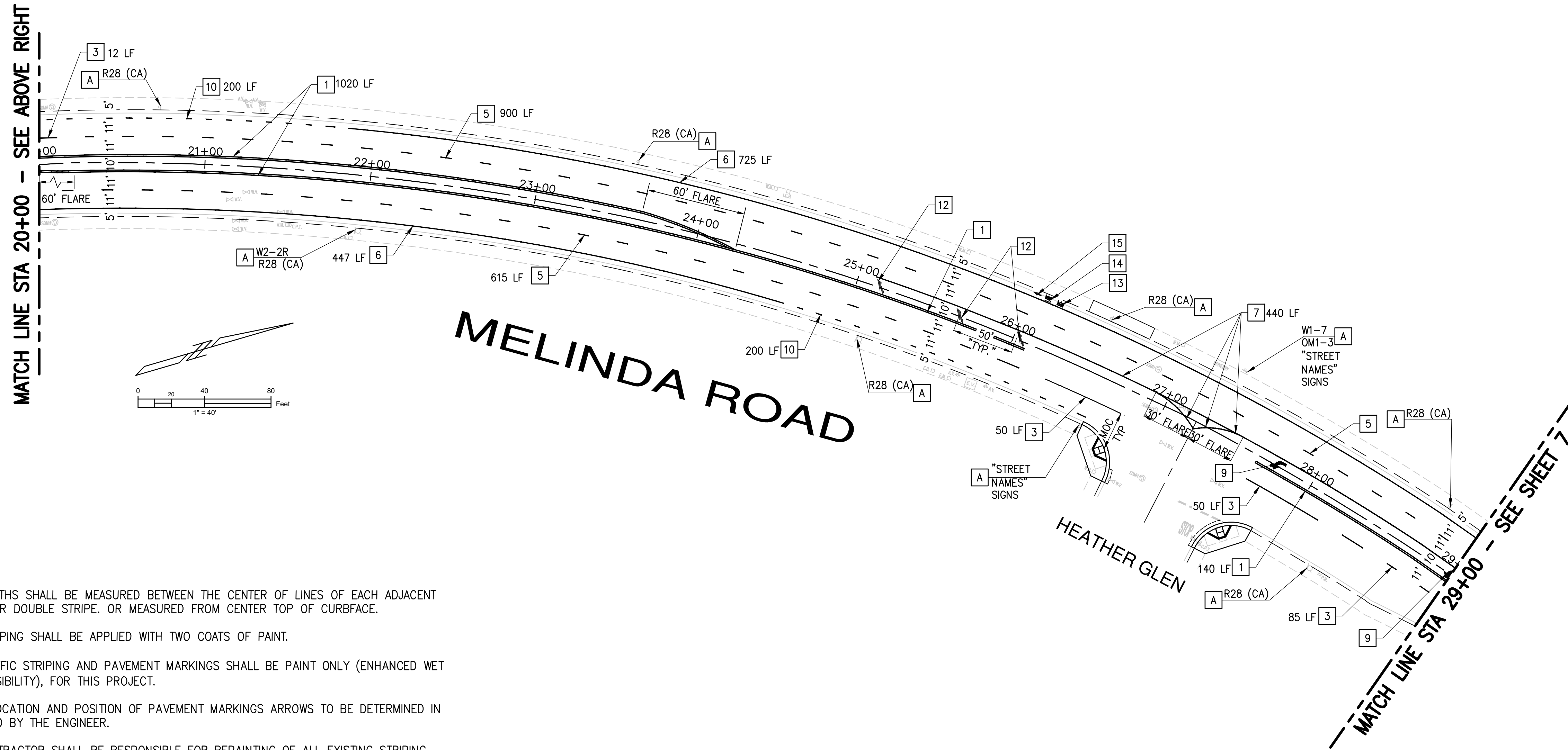

MATCH LINE STA 29+00 - SEE SHEET 7

GENERAL SIGNING AND STRIPING NOTES:

1. CONTRACTOR SHALL REMOVE ALL EXISTING PAVEMENT STRIPING, PAVEMENT MARKING, LEGENDS AND RAISED PAVEMENT MARKERS THAT ARE IN CONFLICT WITH THESE PLANS BY WET SANDBLASTING. SANDBLASTING DEBRIS SHALL BE REMOVED BEFORE THE END OF EACH WORK DAY.
2. ALL STRIPING AND PAVEMENT MARKINGS SHALL BE THE RESPONSIBILITY OF THE CONTRACTOR AND SHALL CONFORM TO SECTION 84 AND 85 OF THE LATEST EDITION OF THE CALTRANS STANDARD SPECIFICATIONS AND THE APPROPRIATE DETAILS IN THE CALIFORNIA MUTCD.
3. FOR ALL REFERENCES TO DETAILS OR FIGURES SHOWN HEREON, REFER TO THE LATEST EDITION OF THE CALTRANS STANDARD PLANS A20A-A20D AND A24A-24E UNLESS OTHERWISE INDICATED.
4. LANE WIDTHS SHALL BE MEASURED BETWEEN THE CENTER OF LINES OF EACH ADJACENT SINGLE OR DOUBLE STRIPE. OR MEASURED FROM CENTER TOP OF CURBFACE.
5. NEW STRIPING SHALL BE APPLIED WITH TWO COATS OF PAINT.
6. ALL TRAFFIC STRIPING AND PAVEMENT MARKINGS SHALL BE PAINT ONLY (ENHANCED WET NIGHT VISIBILITY), FOR THIS PROJECT.
7. EXACT LOCATION AND POSITION OF PAVEMENT MARKINGS ARROWS TO BE DETERMINED IN THE FIELD BY THE ENGINEER.
8. THE CONTRACTOR SHALL BE RESPONSIBLE FOR REPAINTING OF ALL EXISTING STRIPING THAT HAS BEEN DAMAGED DURING THE CONSTRUCTION PROCESS.

8			PLANS PREPARED BY:	3737 BIRCH ST. SUITE 250 NEWPORT BEACH, CA 92660 P: (949) 428-1500 F: (949) 258-5053	REGISTERED PROFESSIONAL ENGINEER LIZETTE BICE NO. 83157 EXP. 3/31/23 CIVIL STATE OF CALIFORNIA	DRAWN BY: AA, KL, JS	DATE: 5/18/22	APPROVED BY: CITY ENGINEER	REFERENCE PLANS	STREET IMPROVEMENT PLAN MELINDA ROAD STRIPING PLANS FROM OLYMPIAD ROAD TO SANTA MARGARITA PARKWAY	PROJECT NO. CIP 837
						DESIGNED BY: EF, MH	DATE: 5/18/22	DATE: 12/1/2022			
7			PREPARED UNDER THE SUPERVISION OF:			CHECKED BY: LB, JB	DATE: 5/26/22	APPROVED BY:		CITY OF MISSION VIEJO PUBLIC WORKS DEPARTMENT	OF 8
6						RECOMMENDED BY:	DATE:				
5											
4											
3											
2											
1											
NO.	DATE	REVISIONS	APP.	DATE							

MATCH LINE STA 29+00 - SEE SHEET 6

MATCH LINE STA 41+00 - SEE ABOVE RIGHT

MATCH LINE STA 41+00 - SEE BELOW LEFT

MATCH LINE STA 53+00 - SEE SHEET 8

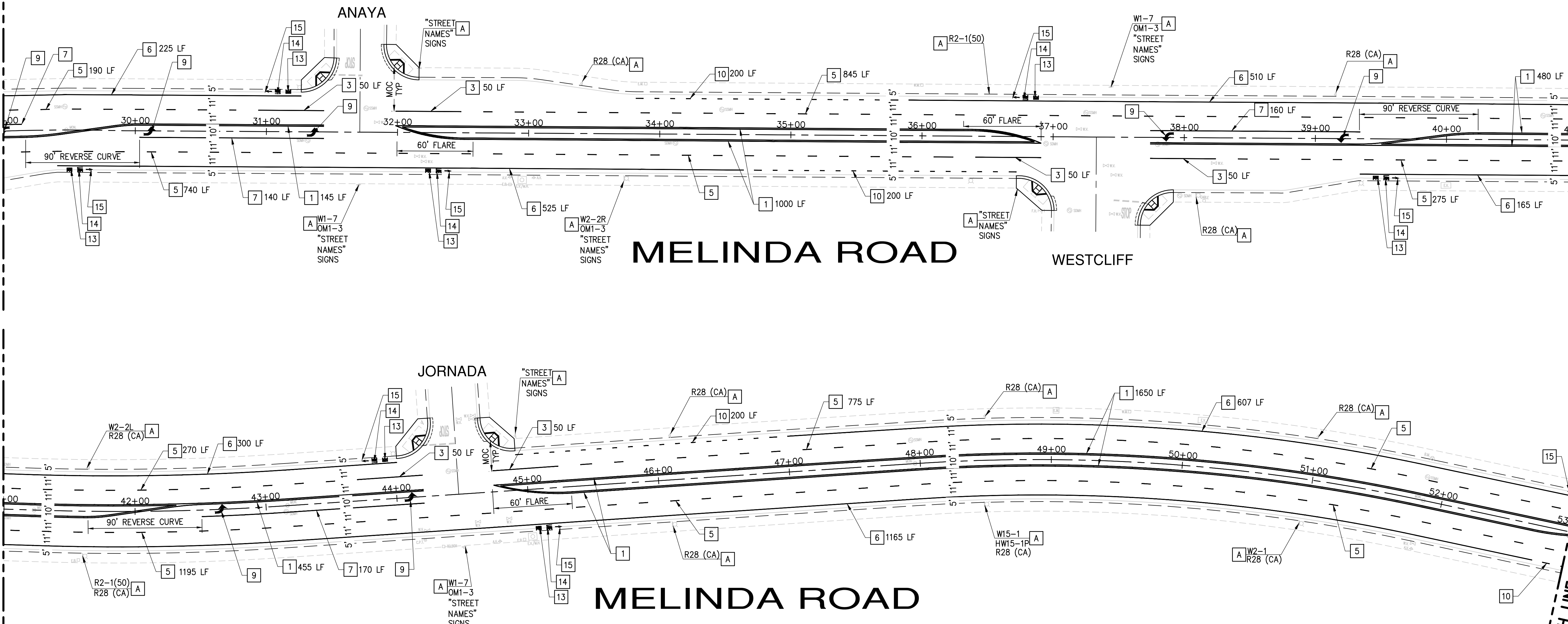

MELINDA ROAD

MELINDA ROAD

STRIPING NOTES

- A PROTECT IN PLACE EXISTING SIGN AND POST
- 1 INSTALL DOUBLE YELLOW PER CALTRANS STD. PLAN A20A, DETAIL 22.
- 3 INSTALL 4" WIDE SOLID WHITE LINE AT INTERSECTION AS SHOWN WITH TYPE G MARKER AT EACH END.
- 5 INSTALL WHITE LANE LINE PER CALTRANS STD. PLAN A20A, DETAIL 9.
- 6 INSTALL SOLID WHITE LINE PER CALTRANS STD. PLAN A20D, DETAIL 39.
- 7 INSTALL SOLID WHITE CHANNELIZING LINE PER CALTRANS STD. PLAN A20D, DETAIL 38.
- 9 INSTALL WHITE TYPE IV LEFT/RIGHT TURN ARROW PER CALTRANS STD. PLAN A24A.
- 10 INSTALL WHITE DASHED LINE PER CALTRANS STD. PLAN A20D, DETAIL 39A.
- 13 INSTALL "BIKE" PAVEMENT MARKING WORD PER CALTRANS STD. PLAN 24D.
- 14 INSTALL "LANE" PAVEMENT MARKING WORD PER CALTRANS STD. PLAN 24D.
- 15 INSTALL BIKE LANE ARROW PAVEMENT MARKING PER CALTRANS STD. PLAN 24A.

NO.	DATE	REVISIONS	APP.	DATE
8				
7				
6				
5				
4				
3				
2				
1				

PLANS PREPARED BY:

3737 BIRCH ST. SUITE 250
NEWPORT BEACH, CA 92660
P: (949) 428-1500
F: (949) 258-5053

PREPARED UNDER THE SUPERVISION OF:

DATE: 11/30/22
R.C.E. NO.: 83157
EXP. 12-31-05



DRAWN BY:	AA, KL, JS	DATE:	5/18/22
DESIGNED BY:	EF, MH	DATE:	5/18/22
CHECKED BY:	LB, JB	DATE:	5/26/22
RECOMMENDED BY:		DATE:	

APPROVED BY:	CITY ENGINEER	DATE:	12/1/2022
	R.C.E. NO. 51160		
APPROVED BY:		DATE:	

REFERENCE PLANS	
-----------------	--

STREET IMPROVEMENT PLAN
MELINDA ROAD
STRIPING PLANS
FROM OLYMPIAD ROAD TO SANTA MARGARITA PARKWAY

CITY OF MISSION VIEJO
PUBLIC WORKS DEPARTMENT

PROJECT NO.	CIP 837
SHEET	7
OF	8

MATCH LINE STA 53+00 - SEE SHEET 7

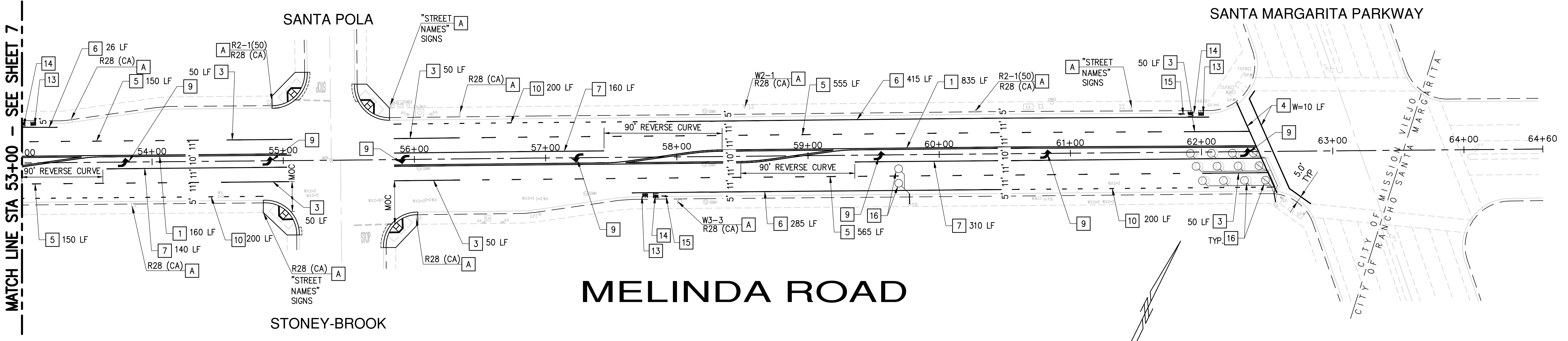

MELINDA ROAD

STRIPING NOTES

- [A] PROTECT IN PLACE EXISTING SIGN AND POST
- [1] INSTALL DOUBLE YELLOW PER CALTRANS STD. PLAN A20A, DETAIL 22.
- [3] INSTALL 4" WIDE SOLID WHITE LINE AT INTERSECTION AS SHOWN WITH TYPE G MARKER AT EACH END.
- [4] INSTALL BASIC CROSSWALK PER CALTRANS STD. PLAN A24F.
- [5] INSTALL WHITE LANE LINE PER CALTRANS STD. PLAN A20A, DETAIL 9.
- [6] INSTALL SOLID WHITE LINE PER CALTRANS STD. PLAN A20D, DETAIL 39.
- [7] INSTALL SOLID WHITE CHANNELIZING LINE PER CALTRANS STD. PLAN A20D, DETAIL 38.
- [9] INSTALL WHITE TYPE IV LEFT/RIGHT TURN ARROW PER CALTRANS STD. PLAN A24A.
- [10] INSTALL WHITE DASHED LINE PER CALTRANS STD. PLAN A20D, DETAIL 39A.
- [13] INSTALL "BIKE" PAVEMENT MARKING WORD PER CALTRANS STD. PLAN 24D.
- [14] INSTALL "LANE" PAVEMENT MARKING WORD PER CALTRANS STD. PLAN 24D.
- [15] INSTALL BIKE LANE ARROW PAVEMENT MARKING PER CALTRANS STD. PLAN 24A.
- [16] CONTRACTOR SHALL REPLACE ALL EXISTING LOOPS WITH TYPE "E" OR MODIFIED TYPE "E" LOOP DETECTOR PER CALTRANS STD. PLAN RSP ES-5B AND SPLICE TO DLC IN ADJACENT PULLBOX AS SHOWN ON PLAN. LOOPS SHALL BE CENTERED IN LANES WITH 10' SPACING IN THE DIRECTION OF TRAVEL AND LOCATED 1' PRIOR TO CROSSWALK.

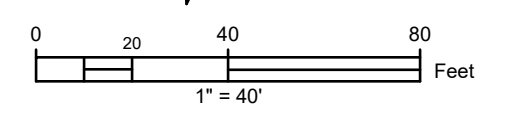

NO.	DATE	REVISIONS	APP.	DATE
8				
7				
6				
5				
4				
3				
2				
1				

PLANS PREPARED BY:

 3737 BIRCH ST. SUITE 250
 NEWPORT BEACH, CA 92660
 P: (949) 428-1500
 F: (949) 258-5053
 PREPARED UNDER THE SUPERVISION OF:

 DATE 11/30/22
 R.C.E. NO.: 83157 EXP. 12-31-05

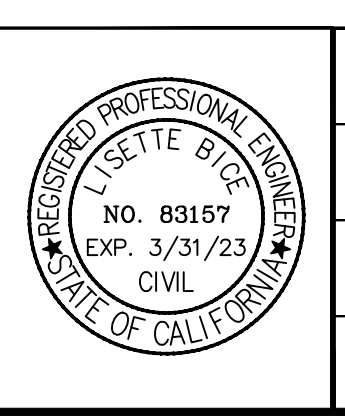

DRAWN BY: AA, KL, JS DATE 5/18/22
 DESIGNED BY: EF, MH DATE 5/18/22
 CHECKED BY: LB, JB DATE 5/26/22
 RECOMMENDED BY: DATE

APPROVED BY: CITY ENGINEER

 DATE: 12/1/2022
 R.C.E. NO. 51160
 APPROVED BY:
 DATE

REFERENCE PLANS

STREET IMPROVEMENT PLAN
 MELINDA ROAD
 STRIPING PLANS
 FROM OLYMPIAD ROAD TO SANTA MARGARITA PARKWAY
 CITY OF MISSION VIEJO
 PUBLIC WORKS DEPARTMENT

PROJECT NO.
 CIP 837
 SHEET 8
 OF 8

APPENDIX E

SANTA MARGARITA WATER DISTRICT ENCROACHMENT PERMIT APPLICATION

ENCROACHMENT PERMIT No. _____

Applicants Please Complete Items 1-7, Read and Initial at the Bottom of Page 2

1. **Location of work:** _____ **City:** _____

Tract: _____ **Lot:** _____ **Est. Start Date:** _____ **Est. Completion Date:** _____

2. **Property Owner:** _____ **Address:** _____ **City:** _____

3. **Applicant:** _____ **Address:** _____ **City:** _____

Contact: _____ **Phone:** _____ **Email:** _____

4. **Required Documents**

- 1 Set of Plans & Paving Schedule
- Copy of Liability Insurance Certificate
- \$320 Fee - Check or Cash only

5. **This work effects: (Choose All Applicable)**

- Domestic Water Non-Domestic
- Sewer SMWD Easement _____

6. **Description Of Work:** _____

Permittee shall contact **SMWD Inspection @ 949/459-6505 and DigAlert @ 811 at least 2 days** prior to commencing any work. Failure to obtain proper inspection may cause permit rejection. This permit and approved plans must be on the job and available to District representatives at all times. In consideration of granting this permit the applicant acknowledges that he has read and agrees to all the terms and conditions attached to this form.

7. _____ **Date:** _____

Applicant's Signature

SMWD Use: Permit Fee \$ _____ **Issue Date:** _____ **Expires:** _____ **CE Approval:** _____

8. Special Conditions of Approval:

	Inspection Assigned to	
Date	Remarks	

Certificate of Inspection:
 I hereby certify that the work allowed by this permit has been constructed according to the plans and specifications and I hereby accept the work in this manner.
 By: _____ Date: _____

Encroachment Permit Terms and Conditions

1. By acceptance of this permit, permittee acknowledges and assumes all responsibility for compliance with requirements of other regulatory governing agencies including but not limited to zoning regulations, applicable ordinances and laws, etc. of the County of Orange, the State of California, or others having regulatory control over the use granted herein.
2. Should any damage or injury to District facilities occur, either through the acts of agents, servants or employees of Permittee or by any independent contractor of Permittee in the exercise of the rights herein granted, Permittee shall immediately, upon the written demand of District, restore such works to the condition of same on the date of the occurrence of said damage or injury at Permittee's cost or expense. Any questions as to whether or not any such damage or injury has been caused to District Facilities shall be determined by the Chief Engineer of the District and the determination shall be final.
3. District reserves the right unto itself to perform any work upon any portion or all of the area covered by this permit, or to do any other work necessary at any time. Such work may be performed without incurring any liability of any nature whatsoever to the Permittee. It is further understood and agreed that District reserves unto itself the right of ingress over any or all portions of the subject area.
4. Permittee further agrees that all operations within District Property and/or easements shall be subject to inspection and/or review at any time by District personnel and/or any other authorized persons under District control. All work is to be done to the satisfaction of the District Inspector.
5. This permit may be immediately revoked for reasons in the best interest of the District including violation of permit provisions or other applicable rules and regulations or for the creation of a nuisance upon notice given by the Chief Engineer of the District or authorized representative. In the event of such revocation, Permittee shall immediately cease all operations and restore District Property and/or easements as directed by assigned inspector.
6. Permittee agrees to perform all work in accordance with the Standard Specifications for Public Works Construction (latest edition); Standard Special Provisions and Standard Drawings of the District; special provisions; and all applicable laws and ordinances.
7. Permittee agrees that the work site shall be kept clean and free of rubbish, debris and dust throughout all phases of construction.
8. District will provide inspection during normal working hours only (7:00 a.m. - 3:30 p.m., Monday – Friday).
9. Trenches exceeding five (5) feet in depth require a permit from the Divisions of Industrial Safety, State of California.
10. Permittee shall pay for all Structural Engineer compaction and materials tests deemed necessary by the District.
11. Access to fire hydrants shall be maintained at all times.
12. Permittee agrees to save District, including its officers, agents or employees, harmless from any and all penalties, liabilities or loss resulting from claims or court actions, arising directly or indirectly out of any damage or injury to person or property by reason of the acts or omissions of Permittee, its agents, employees or independent contractors, in exercising any of the privileges herein granted or in consequence thereof.
13. Permittee shall contact the District's inspector for final inspection prior to the finalization of the permit and /or release for occupancy.

Applicant Initials: _____

APPENDIX F

CALTRANS FEDERAL CONTRACT DOCUMENTS

EXHIBIT 12-G: REQUIRED FEDERAL-AID CONTRACT LANGUAGE
(For Local Assistance Construction Projects)

The following language must be incorporated into all Local Assistance Federal-aid construction contracts.
The following language, with minor edits, was taken from the Code of Federal Regulations.

MAINTAIN RECORDS AND SUBMIT REPORTS DOCUMENTING YOUR PERFORMANCE UNDER THIS SECTION

1. DISADVANTAGED BUSINESS ENTERPRISES (DBE)	2
A. NONDISCRIMINATION STATEMENT	3
B. CONTRACT ASSURANCE	3
C. PROMPT PROGRESS PAYMENT	3
D. PROMPT PAYMENT OF WITHHELD FUNDS TO SUBCONTRACTORS	3
E. TERMINATION AND SUBSTITUTION OF DBE SUBCONTRACTORS	4
F. COMMITMENT AND UTILIZATION	5
G. DBE RUNNING TALLY OF ATTAINMENTS	6
2. BID OPENING	6
3. BID RIGGING	6
4. CONTRACT AWARD	6
5. CONTRACTOR LICENSE	6
6. CHANGED CONDITIONS	6
A. DIFFERING SITE CONDITIONS	6
B. SUSPENSIONS OF WORK ORDERED BY THE ENGINEER	6
C. SIGNIFICANT CHANGES IN THE CHARACTER OF WORK	7
7. BEGINNING OF WORK, TIME OF COMPLETION AND LIQUIDATED DAMAGES	7
8. BUY AMERICA	8
9. QUALITY ASSURANCE	9
10. PROMPT PAYMENT FROM THE AGENCY TO THE CONTRACTORS	9
11. FORM FHWA-1273 REQUIRED CONTRACT PROVISIONS FEDERAL-AID CONTRACTS	9
12. FEMALE AND MINORITY GOALS	22
13. TITLE VI ASSURANCES	23
14. FEDERAL TRAINEE PROGRAM	28
15. PROHIBITIONS OF CERTAIN TELECOMMUNICATIONS AND VIDEO SURVEILLANCE EQUIPMENT AND SERVICES	29

1. DISADVANTAGED BUSINESS ENTERPRISES (DBE)

The contractor, subrecipient or subcontractor shall take necessary and reasonable steps to ensure that DBEs have opportunity to participate in the contract (49 CFR 26). To ensure equal participation of DBEs provided in 49 CFR 26.5, the Agency shows a contract goal for DBEs. The prime contractor shall make work available to DBEs and select work parts consistent with available DBE subcontractors and suppliers.

The prime contractor shall meet the DBE goal shown elsewhere in these special provisions or demonstrate that they made adequate good faith efforts to meet this goal.

It is the prime contractor's responsibility to verify that the DBE firm is certified as a DBE on the date of bid opening by using the California Unified Certification Program (CUCP) database and possesses the most specific available North American Industry Classification System (NAICS) codes and Work Code applicable to the type of work the firm will perform on the contract. Additionally, the prime contractor is responsible to document this verification by printing out the CUCP data for each DBE firm. A list of DBEs certified by the CUCP can be found at: <https://dot.ca.gov/programs/civil-rights/dbe-search>.

All DBE participation will count toward the California Department of Transportation's federally mandated statewide overall DBE goal.

Credit for materials or supplies the prime contractor purchases from DBEs counts towards the goal in the following manner:

- 100 percent counts if the materials or supplies are obtained from a DBE manufacturer.
- 60 percent counts if the materials or supplies are obtained from a DBE regular dealer.
- Only fees, commissions, and charges for assistance in the procurement and delivery of materials or supplies count if obtained from a DBE that is neither a manufacturer nor regular dealer. 49 CFR 26.55 defines "manufacturer" and "regular dealer."

The prime contractor receives credit towards the goal if they employ a DBE trucking company that performs a commercially useful function as defined in 49 CFR 26.55(d) as follows:

- The DBE must be responsible for the management and supervision of the entire trucking operation for which it is responsible on a particular contract, and there cannot be a contrived arrangement for the purpose of meeting DBE goals.
- The DBE must itself own and operate at least one fully licensed, insured, and operational truck used on the contract.
- The DBE receives credit for the total value of the transportation services it provides on the Contract using trucks it owns, insures, and operates using drivers it employs.
- The DBE may lease trucks from another DBE firm, including an owner-operator who is certified as a DBE. The DBE who leases trucks from another DBE receives credit for the total value of the transportation services the lessee DBE provides on the Contract.
- The DBE may also lease trucks from a non-DBE firm, including from an owner-operator. The DBE that leases trucks equipped with drivers from a non-DBE is entitled to credit for the total value of transportation services provided by non-DBE leased trucks equipped with drivers not to exceed the value of transportation services on the contract provided by DBE-owned trucks or leased trucks with DBE employee drivers. Additional participation by non-DBE owned trucks equipped with drivers receives credit only for the fee or commission it receives as a result of the lease arrangement.
- The DBE may lease trucks without drivers from a non-DBE truck leasing company. If the DBE leases trucks from a non-DBE truck leasing company and uses its own employees as drivers, it is entitled to credit for the total value of these hauling services.
- A lease must indicate that the DBE has exclusive use of and control over the truck. This does not preclude the leased truck from working for others during the term of the lease with the consent of the DBE, so long as the lease gives the DBE absolute priority for use of the leased truck. Leased trucks must display the name and identification number of the DBE.

A. Nondiscrimination Statement

The contractor, subrecipient or subcontractor will never exclude any person from participation in, deny any person the benefits of, or otherwise discriminate against anyone in connection with the award and performance of any contract covered by 49 CFR 26 on the basis of race, color, sex, or national origin. In administering the Local Agency components of the DBE Program Plan, the contractor, subrecipient or subcontractor will not, directly, or through contractual or other arrangements, use criteria or methods of administration that have the effect of defeating or substantially impairing accomplishment of the objectives of the DBE Program Plan with respect to individuals of a particular race, color, sex, or national origin.

B. Contract Assurance

Under 49 CFR 26.13(b): The contractor, subrecipient or subcontractor shall not discriminate on the basis of race, color, national origin, or sex in the performance of this contract. The contractor shall carry out applicable requirements of 49 CFR 26 in the award and administration of federal-aid contracts. Failure by the contractor to carry out these requirements is a material breach of this contract, which may result in the termination of this contract or such other remedy as the recipient deems appropriate, which may include, but is not limited to:

- (1) Withholding monthly progress payments;
- (2) Assessing sanctions;
- (3) Liquidated damages; and/or
- (4) Disqualifying the contractor from future bidding as non-responsible.

C. Prompt Progress Payment

The prime contractor or subcontractor shall pay to any subcontractor, not later than seven days after receipt of each progress payment, unless otherwise agreed to in writing, the respective amounts allowed the contractor on account of the work performed by the subcontractors, to the extent of each subcontractor's interest therein. In the event that there is a good faith dispute over all or any portion of the amount due on a progress payment from the prime contractor or subcontractor to a subcontractor, the prime contractor or subcontractor may withhold no more than 150 percent of the disputed amount. Any violation of this requirement shall constitute a cause for disciplinary action and shall subject the licensee to a penalty, payable to the subcontractor, of 2 percent of the amount due per month for every month that payment is not made.

In any action for the collection of funds wrongfully withheld, the prevailing party shall be entitled to his or her attorney's fees and costs. The sanctions authorized under this requirement shall be separate from, and in addition to, all other remedies, either civil, administrative, or criminal. This clause applies to both DBE and non-DBE subcontractors.

D. Prompt Payment of Withheld Funds to Subcontractors

The Agency may hold retainage from the prime contractor and shall make prompt and regular incremental acceptances of portions, as determined by the Agency, of the contract work, and pay retainage to the prime contractor based on these acceptances. The Agency shall designate one of the methods below in the contract to ensure prompt and full payment of any retainage kept by the prime contractor or subcontractor to a subcontractor. The Agency shall include either Method 1, Method 2, or Method 3 below and delete the other two.

Method 1: No retainage will be held by the Agency from progress payments due to the prime contractor. Prime contractors and subcontractors are prohibited from holding retainage from subcontractors. Any delay or postponement of payment may take place only for good cause and with the Agency's prior written approval. Any violation of these provisions shall subject the violating contractor or subcontractor to the penalties, sanctions, and other remedies specified in Section 7108.5 of the California Business and Professions Code and Section 10262 of the California Public Contract Code. This requirement shall not be construed to limit or impair any contractual, administrative or judicial remedies, otherwise available to the contractor or subcontractor in the event of a dispute involving late payment or nonpayment by the contractor, deficient subcontractor performance and/or noncompliance by a subcontractor. This clause applies to both DBE and non-DBE subcontractors.

Method 2: No retainage will be held by the Agency from progress payments due to the prime contractor. Any retainage kept by the prime contractor or by a subcontractor must be paid in full to the earning subcontractor within seven (7) days after the subcontractor's work is satisfactorily completed. Any delay or postponement of payment may take place only for good cause and with the Agency's prior written approval.

Any violation of these provisions shall subject the violating contractor or subcontractor to the penalties, sanctions, and remedies specified in Section 7108.5 of the California Business and Professions Code and Section 10262 of the California Public Contract Code. This requirement shall not be construed to limit or impair any contractual, administrative or judicial remedies, otherwise available to the contractor or subcontractor in the event of a dispute involving late payment or nonpayment by the contractor, deficient subcontractor performance and/or noncompliance by a subcontractor. This clause applies to both DBE and non-DBE subcontractors.

Method 3: The Agency shall hold retainage from the prime contractor and shall make prompt and regular incremental acceptances of portions, as determined by the Agency of the contract work and pay retainage to the prime contractor based on these acceptances. The prime contractor or subcontractor shall return all monies withheld in retention from all subcontractors within seven (7) days after receiving payment for work satisfactorily completed and accepted including incremental acceptances of portions of the contract work by the Agency. Any delay or postponement of payment may take place only for good cause and with the Agency's prior written approval. Any violation of these provisions shall subject the violating prime contractor or subcontractor to the penalties, sanctions, and other remedies specified in Section 7108.5 of the California Business and Professions Code and Section 10262 of the California Public Contract Code. This requirement shall not be construed to limit or impair any contractual, administrative or judicial remedies otherwise available to the contractor or subcontractor in the event of a dispute involving late payment or nonpayment by the contractor; deficient subcontractor performance and/or noncompliance by a subcontractor. This clause applies to both DBE and non-DBE subcontractors.

Any violation of these provisions of Prompt Progress Payment and Prompt Payment of Withheld Funds to Subcontractors shall subject the violating prime contractor or subcontractor to the penalties, sanctions and other remedies specified therein. These requirements shall not be construed to limit or impair any contractual, administrative, or judicial remedies otherwise available to the prime contractor or subcontractor in the event of a dispute involving late payment or nonpayment by the prime contractor, deficient subcontract performance, or noncompliance by a subcontractor.

E. Termination and Substitution of DBE Subcontractors

The prime contractor shall utilize the specific DBEs listed to perform the work and supply the materials for which each is listed unless the contractor obtains the Agency's written consent. The prime contractor shall not terminate or substitute a listed DBE for convenience and perform the work with their own forces or obtain materials from other sources without prior written authorization from the Agency. Unless the Agency's prior written consent is provided, the contractor shall not be entitled to any payment for work or material unless it is performed or supplied by the listed DBE on the Exhibit 15-G Construction Contract DBE Commitment form, included in the Bid.

The Agency authorizes a request to use other forces or sources of materials if the bidder shows any of the following justifications:

1. Listed DBE fails or refuses to execute a written contract based on plans and specifications for the project.
2. The Local Agency stipulated that a bond is a condition of executing the subcontract and the listed DBE fails to meet the Local Agency's bond requirements.
3. Work requires a contractor's license and listed DBE does not have a valid license under Contractors License Law.
4. Listed DBE fails or refuses to perform the work or furnish the listed materials (failing or refusing to perform is not an allowable reason to remove a DBE if the failure or refusal is a result of bad faith or discrimination).
5. Listed DBE's work is unsatisfactory and not in compliance with the contract.
6. Listed DBE is ineligible to work on the project because of suspension or debarment.
7. Listed DBE becomes bankrupt or insolvent.
8. Listed DBE voluntarily withdraws with written notice from the Contract
9. Listed DBE is ineligible to receive credit for the type of work required.
10. Listed DBE owner dies or becomes disabled resulting in the inability to perform the work on the Contract.

11. The Agency determines other documented good cause.

The prime contractor shall notify the original DBE of the intent to use other forces or material sources and provide the reasons, allowing the DBE 5 days to respond to the notice and advise the prime contractor and the Agency of the reasons why the use of other forces or sources of materials should not occur.

The prime contractor's request to use other forces or material sources must include:

1. One or more of the reasons listed in the preceding paragraph.
2. Notices from the prime contractor to the DBE regarding the request.
3. Notices from the DBEs to the prime contractor regarding the request.

If the Agency authorizes the termination or substitution of a listed DBE, the prime contractor must make good faith efforts to find another DBE to substitute for the original DBE. The substitute DBE must (1) perform at least the same amount of work as the original DBE under the contract to the extent needed to meet or exceed the DBE goal, and (2) be certified as a DBE with the most specific available NAICS codes and work codes applicable to the type of work the DBE will perform on the contract at the time of the prime contractor's request for substitution. The prime contractor shall submit their documentation of good faith efforts within 7 days of their request for authorization of the substitution. The Agency may authorize a 7-day extension of this submittal period at the prime contractor's request. More guidance can be found at 49 CFR 26 app A regarding evaluation of good faith efforts to meet the DBE goal.

F. Commitment and Utilization

Note: In the Agency's reports of DBE participation to Caltrans, the Agency must display both commitments and attainments.

The Agency's DBE program must include a monitoring and enforcement mechanism to ensure that DBE commitments reconcile to DBE utilization.

The bidder shall submit the Exhibit 15-G Construction Contract DBE Commitment, included in the Bid book. This exhibit is the bidder's DBE commitment form. If the form is not submitted with the bid, the bidder must remove the form from the Bid book before submitting their bid.

The bidder shall complete and sign Exhibit 15-G Construction Contract DBE Commitment included in the contract documents regardless of whether DBE participation is reported. The bidder shall provide written confirmation from each DBE that the DBE is participating in the Contract. A copy of a DBE's quote serves as written confirmation. If a DBE is participating as a joint venture partner, the bidder shall submit a copy of the joint venture agreement.

If the DBE Commitment form, Exhibit 15-G, is not submitted with the bid, it must be completed and submitted by all bidders to the Agency within five (5) days of bid opening. If the bidder does not submit the DBE Commitment form within the specified time, the Agency will find the bidder's bid nonresponsive.

The prime contractor shall use each DBE subcontractor as listed on Exhibit 12-B Bidder's List of Subcontractors (DBE and Non-DBE), and Exhibit 15-G Construction Contract DBE Commitment form unless they receive authorization for a substitution.

The Agency shall request the prime contractor to:

1. Notify the Resident Engineer or Inspector of any changes to its anticipated DBE participation
2. Provide this notification before starting the affected work
3. Maintain records including:
 - Name and business address of each 1st-tier subcontractor
 - Name and business address of each DBE subcontractor, DBE vendor, and DBE trucking company, regardless of tier
 - Date of payment and total amount paid to each business (see Exhibit 9-F Monthly Disadvantaged Business Enterprise Payment)

If the prime contractor is a DBE contractor, they shall include the date of work performed by their own forces and the corresponding value of the work.

Before the 15th of each month, the prime contractor shall submit a Monthly DBE Trucking Verification (LAPM Exhibit 16-Z1) form.

If a DBE is decertified before completing its work, the DBE must notify the prime contractor in writing of the decertification date. If a business becomes a certified DBE before completing its work, the business must notify the prime contractor in writing of the certification date. The prime contractor shall submit the notifications. Upon work completion, the prime contractor shall complete a Disadvantaged Business Enterprises (DBE) Certification Status Change, Exhibit 17-O, form and submit the form within 30 days of contract acceptance.

Upon work completion, the prime contractor shall complete Exhibit 17-F Final Report – Utilization of Disadvantaged Business Enterprises (DBE), First-Tier Subcontractors and submit it within 90 days of contract acceptance. The Agency will withhold \$10,000 until the form is submitted. The Agency releases the withhold upon submission of the completed form.

G. DBE RUNNING TALLY OF ATTAINMENTS

After submitting an invoice for reimbursement that includes a payment to a DBE, but no later than the 10th of the following month, the prime contractor/consultant shall complete and email the Exhibit 9- F: Disadvantaged Business Enterprise Running Tally of Payments to business.support.unit@dot.ca.gov with a copy to the Agency.

- 2. BID OPENING** The Agency publicly opens and reads bids at the time and place shown on the Notice to Contractors.
- 3. BID RIGGING** The U.S. Department of Transportation (DOT) provides a toll-free hotline to report bid rigging activities. Use the hotline to report bid rigging, bidder collusion, and other fraudulent activities. The hotline number is (800) 424-9071. The service is available 24 hours 7 days a week and is confidential and anonymous. The hotline is part of the DOT's effort to identify and investigate highway construction contract fraud and abuse and is operated under the direction of the DOT Inspector General.
- 4. CONTRACT AWARD** If the Agency awards the contract, the award is made to the lowest responsible and responsive bidder.
- 5. CONTRACTOR LICENSE** The Contractor must be properly licensed as a contractor from contract award through Contract acceptance (Public Contract Code §10164).
- 6. CHANGED CONDITIONS**

A. Differing Site Conditions

1. During the progress of the work, if subsurface or latent physical conditions are encountered at the site differing materially from those indicated in the contract or if unknown physical conditions of an unusual nature, differing materially from those ordinarily encountered and generally recognized as inherent in the work provided for in the contract, are encountered at the site, the party discovering such conditions shall promptly notify the other party in writing of the specific differing conditions before the site is disturbed and before the affected work is performed.
2. Upon written notification, the engineer will investigate the conditions, and if it is determined that the conditions materially differ and cause an increase or decrease in the cost or time required for the performance of any work under the contract, an adjustment, excluding anticipated profits, will be made and the contract modified in writing accordingly. The engineer will notify the contractor of the determination whether or not an adjustment of the contract is warranted.
3. No contract adjustment which results in a benefit to the contractor will be allowed unless the contractor has provided the required written notice.
4. No contract adjustment will be allowed under this clause for any effects caused on unchanged work. *[This provision may be omitted by the Local Agency, at their option.]*

B. Suspensions of Work Ordered by the Engineer

1. If the performance of all or any portion of the work is suspended or delayed by the engineer in writing for an unreasonable period of time (not originally anticipated, customary, or inherent to the construction industry) and the contractor believes that additional compensation and/or contract time is due as a result of such suspension or delay, the contractor shall submit to the engineer in writing a request for adjustment within 7 calendar days of receipt of the notice to resume work. The request

shall set forth the reasons and support for such adjustment.

2. Upon receipt, the engineer will evaluate the contractor's request. If the engineer agrees that the cost and/or time required for the performance of the contract has increased as a result of such suspension and the suspension was caused by conditions beyond the control of and not the fault of the contractor, its suppliers, or subcontractors at any approved tier, and not caused by weather, the engineer will make an adjustment (excluding profit) and modify the contract in writing accordingly. The contractor will be notified of the engineer's determination whether or not an adjustment of the contract is warranted.
3. No contract adjustment will be allowed unless the contractor has submitted the request for adjustment within the time prescribed.
4. No contract adjustment will be allowed under this clause to the extent that performance would have been suspended or delayed by any other cause, or for which an adjustment is provided or excluded under any other term or condition of this contract.

C. Significant Changes in the Character of Work

1. The engineer reserves the right to make, in writing, at any time during the work, such changes in quantities and such alterations in the work as are necessary to satisfactorily complete the project. Such changes in quantities and alterations shall not invalidate the contract nor release the surety, and the contractor agrees to perform the work as altered.
2. If the alterations or changes in quantities significantly change the character of the work under the contract, whether such alterations or changes are in themselves significant changes to the character of the work or by affecting other work cause such other work to become significantly different in character, an adjustment, excluding anticipated profit, will be made to the contract. The basis for the adjustment shall be agreed upon prior to the performance of the work. If a basis cannot be agreed upon, then an adjustment will be made either for or against the contractor in such amount as the engineer may determine to be fair and equitable.
3. If the alterations or changes in quantities do not significantly change the character of the work to be performed under the contract, the altered work will be paid for as provided elsewhere in the contract.
4. The term "significant change" shall be construed to apply only to the following circumstances:
 - When the character of the work as altered differs materially in kind or nature from that involved or included in the original proposed construction; or
 - When a major item of work, as defined elsewhere in the contract, is increased in excess of 125 percent or decreased below 75 percent of the original contract quantity. Any allowance for an increase in quantity shall apply only to that portion in excess of 125 percent of original contract item quantity, or in case of a decrease below 75 percent, to the actual amount of work performed.

7. BEGINNING OF WORK, TIME OF COMPLETION AND LIQUIDATED DAMAGES

The Contractor shall begin work within 15 calendar days after the issuance of the Notice to Proceed.

This work shall be diligently prosecuted to completion before the expiration of _____ WORKING DAYS beginning on the fifteenth calendar day after the date shown on the Notice to Proceed.

The Contractor shall pay to the City/County _____ the sum of \$ _____ per day, for each and every calendar days' delay in finishing the work in excess of the number of working days prescribed above.

8. BUY AMERICA

Buy America Requirements apply to steel and iron, manufactured products, and construction materials permanently incorporated into the project.

Steel and Iron Materials

All steel and iron materials must be melted and manufactured in the United States except:

1. Foreign pig iron and processed, pelletized, and reduced iron ore may be used in the domestic production of the steel and iron materials [60 Fed Reg 15478 (03/24/1995)];
2. If the total combined cost of the materials produced outside the United States does not exceed the greater of 0.1 percent of the total contract amount or \$2,500, materials produced outside the United States may be used if authorized.

Furnish steel and iron materials to be incorporated into the work with certificates of compliance and certified mill test reports. Mill test reports must indicate where the steel and iron were melted and manufactured. All melting and manufacturing processes for these materials, including an application of a coating, must occur in the United States. Coating includes all processes that protect or enhance the value of the material to which the coating is applied.

Manufactured Products

Iron and steel used in precast concrete manufactured products must meet the requirements of the above section (Steel and Iron Materials) regardless of the amount used. Iron and steel used in other manufactured products must meet the requirements of the above section (Steel and Iron Materials) if the weight of steel and iron components constitute 90 percent or more of the total weight of the manufactured product.

Construction Materials

Buy America requirements apply to the following construction materials that are or consist primarily of:

1. Non-ferrous metals
2. Plastic and polymer-based products (including polyvinylchloride, composite building materials, and polymers used in fiber optic cables)
3. Glass (including optic glass)
4. Lumber
5. Drywall

Where one or more of these construction materials have been combined by a manufacturer with other materials through a manufacturing process, Buy America requirements do not apply unless otherwise specified.

Furnish construction materials to be incorporated into the work with certificates of compliance with each project delivery. Manufacturer's certificate of compliance must identify where the construction material was manufactured and attest specifically to Buy America compliance.

All manufacturing processes for these materials must occur in the United States.

Buy America requirements do not apply to the following:

1. Tools and construction equipment used in performing the work
2. Temporary work that is not incorporated into the finished project

Waivers

If Buy America waivers are granted, use the following language to include in the contract:

The following steel and iron products, manufactured products, or construction materials have received an approved Buy America waiver for this contract, and therefore, are not subject to Buy America requirements:

1. _____
2. _____

9. QUALITY ASSURANCE

The Local Agency uses a Quality Assurance Program (QAP) to ensure a material is produced to comply with the Contract. The Local Agency may examine the records and reports of tests the prime contractor performs if they are available at the job site. Schedule work to allow time for QAP.

10. PROMPT PAYMENT FROM THE AGENCY TO THE CONTRACTORS

The Agency shall make any progress payment within 30 days after receipt of an undisputed and properly submitted payment request from a contractor on a construction contract. If the Agency fails to pay promptly, the Agency shall pay interest to the contractor, which accrues at the rate of 10 percent per annum on the principal amount of a money judgment remaining unsatisfied. Upon receipt of a payment request, the Agency shall act in accordance with both of the following:

1. Each payment request shall be reviewed by the Agency as soon as practicable after receipt for the purpose of determining that it is a proper payment request.
2. Any payment request determined not to be a proper payment request suitable for payment shall be returned to the contractor as soon as practicable, but not later than seven (7) days, after receipt. A request returned pursuant to this paragraph shall be accompanied by a document setting forth in writing the reasons why the payment request is not proper.

11. FORM FHWA-1273 REQUIRED CONTRACT PROVISIONS FEDERAL-AID CONTRACTS

*[The following 12 pages must be physically inserted into the contract without modification.
Excluding ATTACHMENT A - EMPLOYMENT AND MATERIALS PREFERENCE FOR APPALACHIAN
DEVELOPMENT HIGHWAY SYSTEM OR APPALACHIAN LOCAL ACCESS ROAD CONTRACTS]*

**REQUIRED CONTRACT
PROVISIONS FEDERAL-AID
CONSTRUCTION CONTRACTS**

- I. General
- II. Nondiscrimination
- III. Non-segregated Facilities
- IV. Davis-Bacon and Related Act Provisions
- V. Contract Work Hours and Safety Standards Act Provisions
- VI. Subletting or Assigning the Contract
- VII. Safety: Accident Prevention
- VIII. False Statements Concerning Highway Projects
- IX. Implementation of Clean Air Act and Federal Water Pollution Control Act
- X. Certification Regarding Debarment, Suspension, Ineligibility and Voluntary Exclusion
- XI. Certification Regarding Use of Contract Funds for Lobbying
- XII. Use of United States-Flag Vessels:

ATTACHMENTS

A. Employment and Materials Preference for Appalachian Development Highway System or Appalachian Local Access Road Contracts (included in Appalachian contracts only)

I. GENERAL

1. Form FHWA-1273 must be physically incorporated in each construction contract funded under title 23, United States Code, as required in 23 CFR 633.102(b) (excluding emergency contracts solely intended for debris removal). The contractor (or subcontractor) must insert this form in each subcontract and further require its inclusion in all lower tier subcontracts (excluding purchase orders, rental agreements and other agreements for supplies or services). 23 CFR633.102(e).

The applicable requirements of Form FHWA-1273 are incorporated by reference for work done under any purchase order, rental agreement or agreement for other services. The prime contractor shall be responsible for compliance by any subcontractor, lower-tier subcontractor or service provider. 23 CFR 633.102(e).

Form FHWA-1273 must be included in all Federal-aid design-build contracts, in all subcontracts and in lower tier subcontracts (excluding subcontracts for design services, purchase orders, rental agreements and other agreements for supplies or services) in accordance with 23 CFR 633.102. The design-builder shall be responsible for compliance by any subcontractor, lower-tier subcontractor or service provider.

Contracting agencies may reference Form FHWA-1273 in solicitation-for-bids or request-for-proposals documents, however, the Form FHWA-1273 must be physically incorporated (not referenced) in all contracts, subcontracts and lower-tier subcontracts (excluding purchase orders, rental agreements and other agreements for supplies or services related to a construction contract). 23 CFR 633.102(b).

2. Subject to the applicability criteria noted in the following sections, these contract provisions shall apply to all work performed on the contract by the contractor's own organization and with the assistance of workers under the contractor's immediate superintendence and to all work performed on the contract by piecework, station work, or by subcontract. 23 CFR 633.102(d).

3. A breach of any of the stipulations contained in these Required Contract Provisions may be sufficient grounds for withholding of progress payments, withholding of final payment, termination of the contract, suspension / debarment or any other action determined to be appropriate by the contracting agency and FHWA.

4. Selection of Labor: During the performance of this contract, the contractor shall not use convict labor for any purpose within the limits of a construction project on a Federal-aid highway unless it is labor performed by convicts who are on parole, supervised release, or probation. 23 U.S.C. 114(b). The term Federal-aid highway does not include roadways functionally classified as local roads or rural minor collectors. 23 U.S.C. 101(a).

II. NONDISCRIMINATION (23 CFR 230.107(a); 23 CFR Part 230, Subpart A, Appendix A; EO 11246)

The provisions of this section related to 23 CFR Part 230, Subpart A, Appendix A are applicable to all Federal-aid construction contracts and to all related construction subcontracts of \$10,000 or more. The provisions of 23 CFR Part 230 are not applicable to material supply, engineering, or architectural service contracts.

In addition, the contractor and all subcontractors must comply with the following policies: Executive Order 11246, 41 CFR Part 60, 29 CFR Parts 1625-1627, 23 U.S.C. 140, Section 504 of the Rehabilitation Act of 1973, as amended (29 U.S.C. 794), Title VI of the Civil Rights Act of 1964, as amended (42 U.S.C. 2000d et seq.), and related regulations including 49 CFR Parts 21, 26, and 27; and 23 CFR Parts 200, 230, and 633.

The contractor and all subcontractors must comply with: the requirements of the Equal Opportunity Clause in 41 CFR 60-1.4(b) and, for all construction contracts exceeding \$10,000, the Standard Federal Employment Opportunity Construction Contract Specifications in 41 CFR 60-4.3.

Note: The U.S. Department of Labor has exclusive authority to determine compliance with Executive Order 11246 and the policies of the Secretary of Labor including 41 CFR Part 60, and 29 CFR Parts 1625-1627. The contracting agency and the FHWA have the authority and the responsibility to ensure compliance with 23 U.S.C. 140, Section 504 of the Rehabilitation Act of 1973, as amended (29 U.S.C. 794), and Title VI of the Civil Rights Act of 1964, as amended (42 U.S.C. 2000d et seq.), and related regulations including 49 CFR Parts 21, 26, and 27; and 23 CFR Parts 200, 230, and 633.

The following provision is adopted from 23 CFR Part 230, Subpart A, Appendix A, with appropriate revisions to conform to the U.S. Department of Labor (US DOL) and FHWA requirements.

1. Equal Employment Opportunity: Equal Employment Opportunity (EEO) requirements not to discriminate and to take affirmative action to assure equal opportunity as set forth under laws, executive orders, rules, regulations (see 28 CFR Part 35, 29 CFR Part 1630, 29 CFR Parts 1625-1627, 41 CFR Part 60 and 49 CFR Part 27) and orders of the Secretary of Labor as modified by the provisions prescribed herein, and imposed pursuant to 23 U.S.C. 140, shall constitute the EEO and specific affirmative action standards for the contractor's project activities under this contract. The provisions of the Americans with Disabilities Act of 1990 (42 U.S.C. 12101 et seq.) set forth under 28 CFR Part 35 and 29 CFR Part 1630 are incorporated by reference in this contract. In the execution of this contract, the contractor agrees to comply with the following minimum specific requirement activities of EEO:

a. The contractor will work with the contracting agency and the Federal Government to ensure that it has made every good faith effort to provide equal opportunity with respect to all of its terms and conditions of employment and in their review of activities under the contract. 23 CFR 230.409 (g)(4) & (5).

b. The contractor will accept as its operating policy the following statement:

"It is the policy of this Company to assure that applicants are employed, and that employees are treated during employment, without regard to their race, religion, sex, sexual orientation, gender identity, color, national origin, age or disability. Such action shall include: employment, upgrading, demotion, or transfer; recruitment or recruitment advertising; layoff or termination; rates of pay or other forms of compensation; and selection for training, including apprenticeship, pre-apprenticeship, and/or on-the-job training."

2. EEO Officer: The contractor will designate and make known to the contracting officers an EEO Officer who will have the responsibility for and must be capable of effectively administering and promoting an active EEO program and who must be assigned adequate authority and responsibility to do so.

3. Dissemination of Policy: All members of the contractor's staff who are authorized to hire, supervise, promote, and discharge employees, or who recommend such action or are substantially involved in such action, will be made fully cognizant of and will implement the contractor's EEO policy and contractual responsibilities to provide EEO in each grade and classification of employment. To ensure that the above agreement will be met, the following actions will be taken as a minimum:

a. Periodic meetings of supervisory and personnel office employees will be conducted before the start of work and then not less often than once every six months, at which time the contractor's EEO policy and its implementation will be reviewed and explained. The meetings will be conducted by the EEO Officer or other knowledgeable company official.

b. All new supervisory or personnel office employees will be given a thorough indoctrination by the EEO Officer, covering all major aspects of the contractor's EEO obligations within thirty days following their reporting for duty with the contractor.

c. All personnel who are engaged in direct recruitment for the project will be instructed by the EEO Officer in the contractor's procedures for locating and hiring minorities and women.

d. Notices and posters setting forth the contractor's EEO policy will be placed in areas readily accessible to employees, applicants for employment and potential employees.

e. The contractor's EEO policy and the procedures to implement such policy will be brought to the attention of employees by means of meetings, employee handbooks, or other appropriate means.

4. Recruitment: When advertising for employees, the contractor will include in all advertisements for employees the notation: "An Equal Opportunity Employer." All such advertisements will be placed in publications having a large circulation among minorities and women in the area from which the project work force would normally be derived.

a. The contractor will, unless precluded by a valid bargaining agreement, conduct systematic and direct recruitment through public and private employee referral sources likely to yield qualified minorities and women. To meet this requirement, the contractor will identify sources of potential minority group employees and establish with such identified sources procedures whereby minority and women applicants may be referred to the contractor for employment consideration.

b. In the event the contractor has a valid bargaining agreement providing for exclusive hiring hall referrals, the contractor is expected to observe the provisions of that agreement to the extent that the system meets the contractor's compliance with EEO contract provisions. Where implementation of such an agreement has the effect of discriminating against minorities or women, or obligates the contractor to do the same, such implementation violates Federal nondiscrimination provisions.

c. The contractor will encourage its present employees to refer minorities and women as applicants for employment. Information and procedures with regard to referring such applicants will be discussed with employees.

5. Personnel Actions: Wages, working conditions, and employee benefits shall be established and administered, and personnel actions of every type, including hiring, upgrading, promotion, transfer, demotion, layoff, and termination, shall be taken without regard to race, color, religion, sex, sexual orientation, gender identity, national origin, age or disability. The following procedures shall be followed:

a. The contractor will conduct periodic inspections of project sites to ensure that working conditions and employee facilities do not indicate discriminatory treatment of project site personnel.

b. The contractor will periodically evaluate the spread of wages paid within each classification to determine any evidence of discriminatory wage practices.

c. The contractor will periodically review selected personnel actions in depth to determine whether there is evidence of discrimination. Where evidence is found, the contractor will promptly take corrective action. If the review indicates that the discrimination may extend beyond the actions reviewed, such corrective action shall include all affected persons.

d. The contractor will promptly investigate all complaints of alleged discrimination made to the contractor in connection with its obligations under this contract, will attempt to resolve such complaints, and will take appropriate corrective action within a reasonable time. If the investigation indicates that the discrimination may affect persons other than the complainant, such corrective action shall include such other persons. Upon completion of each investigation, the contractor will inform every complainant of all of their avenues of appeal.

6. Training and Promotion:

a. The contractor will assist in locating, qualifying, and increasing the skills of minorities and women who are applicants for employment or current employees. Such efforts should be aimed at developing full journey level status employees in the type of trade or job classification involved.

b. Consistent with the contractor's work force requirements and as permissible under Federal and State regulations, the contractor shall make full use of training programs (i.e., apprenticeship and on-the-job training programs for the geographical area of contract performance). In the event a special provision for training is provided under this contract, this subparagraph will be superseded as indicated in the special provision. The contracting agency may reserve training positions for persons who receive welfare assistance in accordance with 23 U.S.C. 140(a).

c. The contractor will advise employees and applicants for employment of available training programs and entrance requirements for each.

d. The contractor will periodically review the training and promotion potential of employees who are minorities and women and will encourage eligible employees to apply for such training and promotion.

7. Unions: If the contractor relies in whole or in part upon unions as a source of employees, the contractor will use good faith efforts to obtain the cooperation of such unions to increase opportunities for minorities and women. 23 CFR 230.409. Actions by the contractor, either directly or through a contractor's association acting as agent, will include the procedures set forth below:

a. The contractor will use good faith efforts to develop, in cooperation with the unions, joint training programs aimed toward qualifying more minorities and women for membership in the unions and increasing the skills of minorities and women so that they may qualify for higher paying employment.

b. The contractor will use good faith efforts to incorporate an EEO clause into each union agreement to the end that such union will be contractually bound to refer applicants without regard to their race, color, religion, sex, sexual orientation, gender identity, national origin, age, or disability.

c. The contractor is to obtain information as to the referral practices and policies of the labor union except that to the extent such information is within the exclusive possession of the labor union and such labor union refuses to furnish such information to the contractor, the contractor shall so certify to the contracting agency and shall set forth what efforts have been made to obtain such information.

d. In the event the union is unable to provide the contractor with a reasonable flow of referrals within the time limit set forth in the collective bargaining agreement, the contractor will, through independent recruitment efforts, fill the employment vacancies without regard to race, color, religion, sex, sexual orientation, gender identity, national origin, age, or disability; making full efforts to obtain qualified and/or qualifiable minorities and women. The failure of a union to provide sufficient referrals (even though it is obligated to provide exclusive referrals under the terms of a collective bargaining agreement) does not relieve the contractor from the requirements of this paragraph. In the event the union referral practice prevents the contractor from meeting the obligations pursuant to Executive Order 11246, as amended, and these special provisions, such contractor shall immediately notify the contracting agency.

8. Reasonable Accommodation for Applicants / Employees with Disabilities: The contractor must be familiar with the requirements for and comply with the Americans with Disabilities Act and all rules and regulations established thereunder. Employers must provide reasonable accommodation in all employment activities unless to do so would cause an undue hardship.

9. Selection of Subcontractors, Procurement of Materials and Leasing of Equipment: The contractor shall not discriminate on the grounds of race, color, religion, sex, sexual orientation, gender identity, national origin, age, or disability in the selection and retention of subcontractors, including procurement of materials and leases of equipment. The contractor shall take all necessary and reasonable steps to ensure nondiscrimination in the administration of this contract.

a. The contractor shall notify all potential subcontractors, suppliers, and lessors of their EEO obligations under this contract.

b. The contractor will use good faith efforts to ensure subcontractor compliance with their EEO obligations.

10. Assurance Required:

a. The requirements of 49 CFR Part 26 and the State DOT's FHWA-approved Disadvantaged Business Enterprise (DBE) program are incorporated by reference.

b. The contractor, subrecipient or subcontractor shall not discriminate on the basis of race, color, national origin, or sex in the performance of this contract. The contractor shall carry out applicable requirements of 49 CFR part 26 in the award and administration of DOT-assisted contracts. Failure by the contractor to carry out these requirements is a material breach of this contract, which may result in the termination of this contract or such other remedy as the recipient deems appropriate, which may include, but is not limited to:

- (1) Withholding monthly progress payments;
- (2) Assessing sanctions;
- (3) Liquidated damages; and/or
- (4) Disqualifying the contractor from future bidding as non-responsible.

c. The Title VI and nondiscrimination provisions of U.S. DOT Order 1050.2A at Appendixes A and E are incorporated by reference. 49 CFR Part 21.

11. Records and Reports: The contractor shall keep such records as necessary to document compliance with the EEO requirements. Such records shall be retained for a period of three years following the date of the final payment to the contractor for all contract work and shall be available at reasonable times and places for inspection by authorized representatives of the contracting agency and the FHWA.

a. The records kept by the contractor shall document the following:

- (1) The number and work hours of minority and non-minority group members and women employed in each work classification on the project;
- (2) The progress and efforts being made in cooperation with unions, when applicable, to increase employment opportunities for minorities and women; and
- (3) The progress and efforts being made in locating, hiring, training, qualifying, and upgrading minorities and women.

b. The contractors and subcontractors will submit an annual report to the contracting agency each July for the duration of the project indicating the number of minority, women, and non-minority group employees currently engaged in each work classification required by the contract work. This information is to be reported on Form FHWA-1391. The staffing data should represent the project work force on board in all or any part of the last payroll period preceding the end of July. If on-the-job training is being required by special provision, the contractor will be required to collect and report training data. The employment data should reflect the work force on board during all or any part of the last payroll period preceding the end of July.

III. NONSEGREGATED FACILITIES

This provision is applicable to all Federal-aid construction contracts and to all related construction subcontracts of more than \$10,000. 41 CFR 60-1.5.

As prescribed by 41 CFR 60-1.8, the contractor must ensure that facilities provided for employees are provided in such a manner that segregation on the basis of race, color, religion, sex, sexual orientation, gender identity, or national origin cannot result. The contractor may neither require such segregated use by written or oral policies nor tolerate such use by employee custom. The contractor's obligation extends further to ensure that its employees are not assigned to perform their services at any location under the contractor's control where the facilities are segregated. The term "facilities" includes waiting rooms, work areas, restaurants and other eating areas, time clocks, restrooms, washrooms, locker rooms and other storage or dressing areas, parking lots, drinking fountains, recreation or entertainment areas, transportation, and housing provided for employees. The contractor shall provide separate or single-user restrooms and necessary dressing or sleeping areas to assure privacy between sexes.

IV. DAVIS-BACON AND RELATED ACT PROVISIONS

This section is applicable to all Federal-aid construction projects exceeding \$2,000 and to all related subcontracts and lower-tier subcontracts (regardless of subcontract size), in accordance with 29 CFR 5.5. The requirements apply to all projects located within the right-of-way of a roadway that is functionally classified as Federal-aid highway. 23 U.S.C. 113. This excludes roadways functionally classified as local roads or rural minor collectors, which are exempt. 23 U.S.C. 101. Where applicable law requires that projects be treated as a project on a Federal-aid highway, the provisions of this subpart will apply regardless of the location of the project. Examples include: Surface Transportation Block Grant Program projects funded under 23 U.S.C. 133 [excluding recreational trails projects], the Nationally Significant Freight and Highway Projects funded under 23 U.S.C. 117, and National Highway Freight Program projects funded under 23 U.S.C. 167.

The following provisions are from the U.S. Department of Labor regulations in 29 CFR 5.5 "Contract provisions and related matters" with minor revisions to conform to the FHWA-1273 format and FHWA program requirements.

1. Minimum wages (29 CFR 5.5)

a. All laborers and mechanics employed or working upon the site of the work, will be paid unconditionally and not less often than once a week, and without subsequent deduction or rebate on any account (except such payroll deductions as are permitted by regulations issued by the Secretary of Labor under the Copeland Act (29 CFR part 3)), the full amount of wages and bona fide fringe benefits (or cash equivalents thereof) due at time of payment computed at rates not less than those contained in the wage determination of the Secretary of Labor which is attached hereto and made a part hereof, regardless of any contractual relationship which may be alleged to exist between the contractor and such laborers and mechanics.

Contributions made or costs reasonably anticipated for bona fide fringe benefits under section 1(b)(2) of the Davis-Bacon Act on behalf of laborers or mechanics are considered wages paid to such laborers or mechanics, subject to the provisions of paragraph 1.d. of this section; also, regular contributions made or costs incurred for more than a weekly period (but not less often than quarterly) under plans, funds, or programs which cover the particular weekly period, are deemed to be constructively made or incurred during such weekly period. Such laborers and mechanics shall be paid the appropriate wage rate and fringe benefits on the wage determination for the classification of work actually performed, without regard to skill, except as provided in 29 CFR 5.5(a)(4). Laborers or mechanics performing work in more than one classification may be compensated at the rate specified for each classification for the time actually worked therein: Provided, That the employer's payroll records accurately set forth the time spent in each classification in which work is performed. The wage determination (including any additional classification and wage rates conformed under paragraph 1.b. of this section) and the Davis-Bacon poster (WH-1321) shall be posted at all times by the contractor and its subcontractors at the site of the work in a prominent and accessible place where it can be easily seen by the workers.

- b. (1) The contracting officer shall require that any class of laborers or mechanics, including helpers, which is not listed in the wage determination and which is to be employed under the contract shall be classified in conformance with the wage determination. The contracting officer shall approve an additional classification and wage rate and fringe benefits therefore only when the following criteria have been met:
- (i) The work to be performed by the classification requested is not performed by a classification in the wage determination; and
 - (ii) The classification is utilized in the area by the construction industry; and
 - (iii) The proposed wage rate, including any bona fide fringe benefits, bears a reasonable relationship to the wage rates contained in the wage determination.
- (2) If the contractor and the laborers and mechanics to be employed in the classification (if known), or their representatives, and the contracting officer agree on the classification and wage rate (including the amount designated for fringe benefits where appropriate), a report of the action taken shall be sent by the contracting officer to the Administrator of the Wage and Hour Division, U.S. Department of Labor, Washington, DC 20210. The Administrator, or an authorized representative, will approve, modify, or disapprove every additional classification action within 30 days of receipt and so advise the contracting officer or will notify the contracting officer within the 30-day period that additional time is necessary.

(3) In the event the contractor, the laborers or mechanics to be employed in the classification or their representatives, and the contracting officer do not agree on the proposed classification and wage rate (including the amount designated for fringe benefits, where appropriate), the contracting officer shall refer the questions, including the views of all interested parties and the recommendation of the contracting officer, to the Administrator for determination. The Administrator, or an authorized representative, will issue a determination within 30 days of receipt and so advise the contracting officer or will notify the contracting officer within the 30-day period that additional time is necessary.

(4) The wage rate (including fringe benefits where appropriate) determined pursuant to paragraphs 1.b.(2) or 1.b.(3) of this section, shall be paid to all workers performing work in the classification under this contract from the first day on which work is performed in the classification.

c. Whenever the minimum wage rate prescribed in the contract for a class of laborers or mechanics includes a fringe benefit which is not expressed as an hourly rate, the contractor shall either pay the benefit as stated in the wage determination or shall pay another bona fide fringe benefit or an hourly cash equivalent thereof.

d. If the contractor does not make payments to a trustee or other third person, the contractor may consider as part of the wages of any laborer or mechanic the amount of any costs reasonably anticipated in providing bona fide fringe benefits under a plan or program, Provided, That the Secretary of Labor has found, upon the written request of the contractor, that the applicable standards of the Davis-Bacon Act have been met. The Secretary of Labor may require the contractor to set aside in a separate account assets for the meeting of obligations under the plan or program.

2. Withholding (29 CFR 5.5)

The contracting agency shall upon its own action or upon written request of an authorized representative of the Department of Labor, withhold or cause to be withheld from the contractor under this contract, or any other Federal contract with the same prime contractor, or any other federally-assisted contract subject to Davis-Bacon prevailing wage requirements, which is held by the same prime contractor, so much of the accrued payments or advances as may be considered necessary to pay laborers and mechanics, including apprentices, trainees, and helpers, employed by the contractor or any subcontractor the full amount of wages required by the contract. In the event of failure to pay any laborer or mechanic, including any apprentice, trainee, or helper, employed or working on the site of the work, all or part of the wages required by the contract, the contracting agency may, after written notice to the contractor, take such action as may be necessary to cause the suspension of any further payment, advance, or guarantee of funds until such violations have ceased.

3. Payrolls and basic records (29 CFR 5.5)

a. Payrolls and basic records relating thereto shall be maintained by the contractor during the course of the work and preserved for a period of three years thereafter for all laborers and mechanics working at the site of the work. Such records shall contain the name, address, and social security number of each such worker, his or her correct classification, hourly rates of wages paid (including rates of contributions or costs anticipated for bona fide fringe benefits or cash equivalents thereof of the types described in section 1(b)(2)(B) of the Davis-Bacon Act), daily and weekly number of hours worked, deductions made and actual wages paid. Whenever the Secretary of Labor has found under 29 CFR 5.5(a)(1)(iv) that the wages of any laborer or mechanic include the amount of any costs reasonably anticipated in providing benefits under a plan or program described in section 1(b)(2)(B) of the Davis-Bacon Act, the contractor shall maintain records which show that the commitment to provide such benefits is enforceable, that the plan or program is financially responsible, and that the plan or program has been communicated in writing to the laborers or mechanics affected, and records which show the costs anticipated or the actual cost incurred in providing such benefits. Contractors employing apprentices or trainees under approved programs shall maintain written evidence of the registration of apprenticeship programs and certification of trainee programs, the registration of the apprentices and trainees, and the ratios and wage rates prescribed in the applicable programs.

b. (1) The contractor shall submit weekly for each week in which any contract work is performed a copy of all payrolls to the contracting agency. The payrolls submitted shall set out accurately and completely all of the information required to be maintained under 29 CFR 5.5(a)(3)(i), except that full social security numbers and home addresses shall not be included on weekly transmittals. Instead the payrolls shall only need to include an individually identifying number for each employee (e.g., the last four digits of the employee's social security number). The required weekly payroll information may be submitted in any form desired. Optional Form WH-347 is available for this purpose from the Wage and Hour Division Web site. The prime contractor is responsible for the submission of copies of payrolls by all subcontractors. Contractors and subcontractors shall maintain the full social security number and current address of each covered worker, and shall provide them upon request to the contracting agency for transmission to the State DOT, the FHWA or the Wage and Hour Division of the Department of Labor for purposes of an investigation or audit of compliance with prevailing wage requirements. It is not a violation of this section for a prime contractor to require a subcontractor to provide addresses and social security numbers to the prime contractor for its own records, without weekly submission to the contracting agency.

(2) Each payroll submitted shall be accompanied by a "Statement of Compliance," signed by the contractor or subcontractor or his or her agent who pays or supervises the payment of the persons employed under the contract and shall certify the following:

(i) That the payroll for the payroll period contains the information required to be provided under 29 CFR 5.5(a)(3)(ii), the appropriate information is being maintained under 29 CFR 5.5(a)(3)(i), and that such information is correct and complete;

(ii) That each laborer or mechanic (including each helper, apprentice, and trainee) employed on the contract during the payroll period has been paid the full weekly wages earned, without rebate, either directly or indirectly, and that no deductions have been made either directly or indirectly from the full wages earned, other than permissible deductions as set forth in 29 CFR part 3;

(iii) That each laborer or mechanic has been paid not less than the applicable wage rates and fringe benefits or cash equivalents for the classification of work performed, as specified in the applicable wage determination incorporated into the contract.

(3) The weekly submission of a properly executed certification set forth on the reverse side of Optional Form WH-347 shall satisfy the requirement for submission of the "Statement of Compliance" required by paragraph 3.b.(2) of this section.

(4) The falsification of any of the above certifications may subject the contractor or subcontractor to civil or criminal prosecution under 18 U.S.C. 1001 and 31 U.S.C. 231.

c. The contractor or subcontractor shall make the records required under paragraph 3.a. of this section available for inspection, copying, or transcription by authorized representatives of the contracting agency, the State DOT, the FHWA, or the Department of Labor, and shall permit such representatives to interview employees during working hours on the job. If the contractor or subcontractor fails to submit the required records or to make them available, the FHWA may, after written notice to the contractor, the contracting agency or the State DOT, take such action as may be necessary to cause the suspension of any further payment, advance, or guarantee of funds. Furthermore, failure to submit the required records upon request or to make such records available may be grounds for debarment action pursuant to 29 CFR 5.12.

4. Apprentices and trainees (29 CFR 5.5)

a. Apprentices (programs of the USDOL).

Apprentices will be permitted to work at less than the predetermined rate for the work they performed when they are employed pursuant to and individually registered in a bona fide apprenticeship program registered with the U.S. Department of Labor, Employment and Training Administration, Office of Apprenticeship Training, Employer and Labor Services, or with a State Apprenticeship Agency recognized by the Office, or if a person is employed in his or her first 90 days of probationary employment as an apprentice in such an apprenticeship program, who is not individually registered in the program, but who has been certified by the Office of Apprenticeship Training, Employer and Labor Services or a State Apprenticeship Agency (where appropriate) to be eligible for probationary employment as an apprentice.

The allowable ratio of apprentices to journeymen on the job site in any craft classification shall not be greater than the ratio permitted to the contractor as to the entire work force under the registered program. Any worker listed on a payroll at an apprentice wage rate, who is not registered or otherwise employed as stated above, shall be paid not less than the applicable wage rate on the wage determination for the classification of work actually performed. In addition, any apprentice performing work on the job site in excess of the ratio permitted under the registered program shall be paid not less than the applicable wage rate on the wage determination for the work actually performed. Where a contractor is performing construction on a project in a locality other than that in which its program is registered, the ratios and wage rates (expressed in percentages of the journeyman's hourly rate) specified in the contractor's or subcontractor's registered program shall be observed.

Every apprentice must be paid at not less than the rate specified in the registered program for the apprentice's level of progress, expressed as a percentage of the journeyman hourly rate specified in the applicable wage determination. Apprentices shall be paid fringe benefits in accordance with the provisions of the apprenticeship program. If the apprenticeship program does not specify fringe benefits, apprentices must be paid the full amount of fringe benefits listed on the wage determination for the applicable classification. If the Administrator determines that a different practice prevails for the applicable apprentice classification, fringes shall be paid in accordance with that determination.

In the event the Office of Apprenticeship Training, Employer and Labor Services, or a State Apprenticeship Agency recognized by the Office, withdraws approval of an apprenticeship program, the contractor will no longer be permitted to utilize apprentices at less than the applicable predetermined rate for the work performed until an acceptable program is approved.

b. Trainees (programs of the USDOL).

Except as provided in 29 CFR 5.16, trainees will not be permitted to work at less than the predetermined rate for the work performed unless they are employed pursuant to and individually registered in a program which has received prior approval, evidenced by formal certification by the U.S. Department of Labor, Employment and Training Administration.

The ratio of trainees to journeymen on the job site shall not be greater than permitted under the plan approved by the Employment and Training Administration.

Every trainee must be paid at not less than the rate specified in the approved program for the trainee's level of progress, expressed as a percentage of the journeyman hourly rate specified in the applicable wage determination. Trainees shall be paid fringe benefits in accordance with the provisions of the trainee program. If the trainee program does not mention fringe benefits, trainees shall be paid the full amount of fringe benefits listed on the wage determination unless the Administrator of the Wage and Hour Division determines that there is an apprenticeship program associated with the corresponding journeyman wage rate on the wage determination which provides for less than full fringe benefits for apprentices. Any employee listed on the payroll at a trainee rate who is not registered and participating in a training plan approved by the Employment and Training Administration shall be paid not less than the applicable wage rate on the wage determination for the classification of work actually performed. In addition, any trainee performing work on the job site in excess of the ratio permitted under the registered program shall be paid not less than the applicable wage rate on the wage determination for the work actually performed.

In the event the Employment and Training Administration withdraws approval of a training program, the contractor will no longer be permitted to utilize trainees at less than the applicable predetermined rate for the work performed until an acceptable program is approved.

c. Equal employment opportunity. The utilization of apprentices, trainees and journeymen under this part shall be in conformity with the equal employment opportunity requirements of Executive Order 11246, as amended, and 29 CFR part 30.

d. Apprentices and Trainees (programs of the U.S. DOT).

Apprentices and trainees working under apprenticeship and skill training programs which have been certified by the Secretary of Transportation as promoting EEO in connection with Federal-aid highway construction programs are not subject to the requirements of paragraph 4 of this Section IV. 23 CFR 230.111(e)(2). The straight time hourly wage rates for apprentices and trainees under such programs will be established by the particular programs. The ratio of apprentices and trainees to journeymen shall not be greater than permitted by the terms of the particular program.

5. Compliance with Copeland Act requirements. The contractor shall comply with the requirements of 29 CFR part 3, which are incorporated by reference in this contract as provided in 29 CFR 5.5.

6. Subcontracts. The contractor or subcontractor shall insert Form FHWA-1273 in any subcontracts and also require the subcontractors to include Form FHWA-1273 in any lower tier subcontracts. The prime contractor shall be responsible for the compliance by any subcontractor or lower tier subcontractor with all the contract clauses in 29 CFR 5.5.

7. Contract termination: debarment. A breach of the contract clauses in 29 CFR 5.5 may be grounds for termination of the contract, and for debarment as a contractor and a subcontractor as provided in 29 CFR 5.12.

8. Compliance with Davis-Bacon and Related Act requirements. All rulings and interpretations of the Davis-Bacon and Related Acts contained in 29 CFR parts 1, 3, and 5 are herein incorporated by reference in this contract as provided in 29 CFR 5.5.

9. Disputes concerning labor standards. As provided in 29 CFR 5.5, disputes arising out of the labor standards provisions of this contract shall not be subject to the general disputes clause of this contract. Such disputes shall be resolved in accordance with the procedures of the Department of Labor set forth in 29 CFR parts 5, 6, and 7. Disputes within the meaning of this clause include disputes between the contractor (or any of its subcontractors) and the contracting agency, the U.S. Department of Labor, or the employees or their representatives.

10. Certification of eligibility (29 CFR 5.5)

a. By entering into this contract, the contractor certifies that neither it (nor he or she) nor any person or firm who has an interest in the contractor's firm is a person or firm ineligible to be awarded Government contracts by virtue of section 3(a) of the Davis-Bacon Act or 29 CFR 5.12(a)(1).

b. No part of this contract shall be subcontracted to any person or firm ineligible for award of a Government contract by virtue of section 3(a) of the Davis-Bacon Act or 29 CFR 5.12(a)(1).

c. The penalty for making false statements is prescribed in the U.S. Criminal Code, 18 U.S.C. 1001.

V. CONTRACT WORK HOURS AND SAFETY STANDARDS ACT

Pursuant to 29 CFR 5.5(b), the following clauses apply to any Federal-aid construction contract in an amount in excess of \$100,000 and subject to the overtime provisions of the Contract Work Hours and Safety Standards Act. These clauses shall be inserted in addition to the clauses required by 29 CFR 5.5(a) or 29 CFR 4.6. As used in this paragraph, the terms laborers and mechanics include watchmen and guards.

1. Overtime requirements. No contractor or subcontractor contracting for any part of the contract work which may require or involve the employment of laborers or mechanics shall require or permit any such laborer or mechanic in any workweek in which he or she is employed on such work to work in excess of forty hours in such workweek unless such laborer or mechanic receives compensation at a rate not less than one and one-half times the basic rate of pay for all hours worked in excess of forty hours in such workweek. 29 CFR 5.5.

2. Violation; liability for unpaid wages; liquidated damages. In the event of any violation of the clause set forth in paragraph 1 of this section, the contractor and any subcontractor responsible therefor shall be liable for the unpaid wages. In addition, such contractor and subcontractor shall be liable to the United States (in the case of work done under contract for the District of Columbia or a territory, to such District or to such territory), for liquidated damages. Such liquidated damages shall be computed with respect to each individual laborer or mechanic, including watchmen and guards, employed in violation of the clause set forth in paragraph 1 of this section, in the sum currently provided in 29 CFR 5.5(b)(2)* for each calendar day on which such individual was required or permitted to work in excess of the standard workweek of forty hours without payment of the overtime wages required by the clause set forth in paragraph 1 of this section. 29 CFR 5.5.

* \$27 as of January 23, 2019 (See 84 FR 213-01, 218) as may be adjusted annually by the Department of Labor; pursuant to the Federal Civil Penalties Inflation Adjustment Act of 1990).

3. Withholding for unpaid wages and liquidated damages. The FHWA or the contracting agency shall upon its own action or upon written request of an authorized representative of the Department of Labor withhold or cause to be withheld, from any moneys payable on account of work performed by the contractor or subcontractor under any such contract or any other Federal contract with the same prime contractor, or any other federally-assisted contract subject to the Contract Work Hours and Safety Standards Act, which is held by the same prime contractor, such sums as may be determined to be necessary to satisfy any liabilities of such contractor or subcontractor for unpaid wages and liquidated damages as provided in the clause set forth in paragraph 2 of this section. 29 CFR 5.5.

4. Subcontracts. The contractor or subcontractor shall insert in any subcontracts the clauses set forth in paragraphs 1 through 4 of this section and also a clause requiring the subcontractors to include these clauses in any lower tier subcontracts. The prime contractor shall be responsible for compliance by any subcontractor or lower tier subcontractor with the clauses set forth in paragraphs 1 through 4 of this section. 29 CFR 5.5.

VI. SUBLETTING OR ASSIGNING THE CONTRACT

This provision is applicable to all Federal-aid construction contracts on the National Highway System pursuant to 23 CFR 635.116.

1. The contractor shall perform with its own organization contract work amounting to not less than 30 percent (or a greater percentage if specified elsewhere in the contract) of the total original contract price, excluding any specialty items designated by the contracting agency. Specialty items may be performed by subcontract and the amount of any such specialty items performed may be deducted from the total original contract price before computing the amount of work required to be performed by the contractor's own organization (23 CFR 635.116).

a. The term "perform work with its own organization" in paragraph 1 of Section VI refers to workers employed or leased by the prime contractor, and equipment owned or rented by the prime contractor, with or without operators. Such term does not include employees or equipment of a subcontractor or lower tier subcontractor, agents of the prime contractor, or any other assignees. The term may include payments for the costs of hiring leased employees from an employee leasing firm meeting all relevant Federal and State regulatory requirements. Leased employees may only be included in this term if the prime contractor meets all of the following conditions: (based on longstanding interpretation)

(1) the prime contractor maintains control over the supervision of the day-to-day activities of the leased employees;

(2) the prime contractor remains responsible for the quality of the work of the leased employees;

(3) the prime contractor retains all power to accept or exclude individual employees from work on the project; and

(4) the prime contractor remains ultimately responsible for the payment of predetermined minimum wages, the submission of payrolls, statements of compliance and all other Federal regulatory requirements.

b. "Specialty Items" shall be construed to be limited to work that requires highly specialized knowledge, abilities, or equipment not ordinarily available in the type of contracting organizations qualified and expected to bid or propose on the contract as a whole and in general are to be limited to minor components of the overall contract. 23 CFR 635.102.

2. Pursuant to 23 CFR 635.116(a), the contract amount upon which the requirements set forth in paragraph (1) of Section VI is computed includes the cost of material and manufactured products which are to be purchased or produced by the contractor under the contract provisions.

3. Pursuant to 23 CFR 635.116(c), the contractor shall furnish (a) a competent superintendent or supervisor who is employed by the firm, has full authority to direct performance of the work in accordance with the contract requirements, and is in charge of all construction operations (regardless of who performs the work) and (b) such other of its own organizational resources (supervision, management, and engineering services) as the contracting officer determines is necessary to assure the performance of the contract.

4. No portion of the contract shall be sublet, assigned or otherwise disposed of except with the written consent of the contracting officer, or authorized representative, and such consent when given shall not be construed to relieve the contractor of any responsibility for the fulfillment of the contract. Written consent will be given only after the contracting agency has assured that each subcontract is evidenced in writing and that it contains all pertinent provisions and requirements of the prime contract. (based on long-standing interpretation of 23 CFR 635.116).

5. The 30-percent self-performance requirement of paragraph (1) is not applicable to design-build contracts; however, contracting agencies may establish their own self-performance requirements. 23 CFR 635.116(d).

VII. SAFETY: ACCIDENT PREVENTION

This provision is applicable to all Federal-aid construction contracts and to all related subcontracts.

1. In the performance of this contract the contractor shall comply with all applicable Federal, State, and local laws governing safety, health, and sanitation (23 CFR Part 635). The contractor shall provide all safeguards, safety devices and protective equipment and take any other needed actions as it determines, or as the contracting officer may determine, to be reasonably necessary to protect the life and health of employees on the job and the safety of the public and to protect property in connection with the performance of the work covered by the contract. 23 CFR 635.108.

2. It is a condition of this contract, and shall be made a condition of each subcontract, which the contractor enters into pursuant to this contract, that the contractor and any subcontractor shall not permit any employee, in performance of the contract, to work in surroundings or under conditions which are unsanitary, hazardous or dangerous to his/her health or safety, as determined under construction safety and health standards (29 CFR Part 1926) promulgated by the Secretary of Labor, in accordance with Section 107 of the Contract Work Hours and Safety Standards Act (40 U.S.C. 3704). 29 CFR 1926.10.

3. Pursuant to 29 CFR 1926.3, it is a condition of this contract that the Secretary of Labor or authorized representative thereof, shall have right of entry to any site of contract performance to inspect or investigate the matter of compliance with the construction safety and health standards and to carry out the duties of the Secretary under Section 107 of the Contract Work Hours and Safety Standards Act (40 U.S.C. 3704).

VIII. FALSE STATEMENTS CONCERNING HIGHWAY PROJECTS

This provision is applicable to all Federal-aid construction contracts and to all related subcontracts.

In order to assure high quality and durable construction in conformity with approved plans and specifications and a high degree of reliability on statements and representations made by engineers, contractors, suppliers, and workers on Federal-aid highway projects, it is essential that all persons concerned with the project perform their functions as carefully, thoroughly, and honestly as possible. Willful falsification, distortion, or misrepresentation with respect to any facts related to the project is a violation of Federal law. To prevent any misunderstanding regarding the seriousness of these and similar acts, Form FHWA-1022 shall be posted on each Federal-aid highway project (23 CFR Part 635) in one or more places where it is readily available to all persons concerned with the project:

18 U.S.C. 1020 reads as follows:

"Whoever, being an officer, agent, or employee of the United States, or of any State or Territory, or whoever, whether a person, association, firm, or corporation, knowingly makes any false statement, false representation, or false report as to the character, quality, quantity, or cost of the material used or to be used, or the quantity or quality of the work performed or to be performed, or the cost thereof in connection with the submission of plans, maps, specifications, contracts, or costs of construction on any highway or related project submitted for approval to the Secretary of Transportation; or

Whoever knowingly makes any false statement, false representation, false report or false claim with respect to the character, quality, quantity, or cost of any work performed or to be performed, or materials furnished or to be furnished, in connection with the construction of any highway or related project approved by the Secretary of Transportation; or

Whoever knowingly makes any false statement or false representation as to material fact in any statement, certificate, or report submitted pursuant to provisions of the Federal-aid Roads Act approved July 11, 1916, (39 Stat. 355), as amended and supplemented;

Shall be fined under this title or imprisoned not more than 5 years or both."

IX. IMPLEMENTATION OF CLEAN AIR ACT AND FEDERAL WATER POLLUTION CONTROL ACT (42 U.S.C. 7606; 2 CFR 200.88; EO 11738)

This provision is applicable to all Federal-aid construction contracts in excess of \$150,000 and to all related subcontracts. 48 CFR 2.101; 2 CFR 200.326.

By submission of this bid/proposal or the execution of this contract or subcontract, as appropriate, the bidder, proposer, Federal-aid construction contractor, subcontractor, supplier, or vendor agrees to comply with all applicable standards, orders or regulations issued pursuant to the Clean Air Act (42 U.S.C. 7401-7671q) and the Federal Water Pollution Control Act, as amended (33 U.S.C. 1251-1387). Violations must be reported to the Federal Highway Administration and the Regional Office of the Environmental Protection Agency. 2 CFR Part 200, Appendix II.

The contractor agrees to include or cause to be included the requirements of this Section in every subcontract, and further agrees to take such action as the contracting agency may direct as a means of enforcing such requirements. 2 CFR 200.326.

X. CERTIFICATION REGARDING DEBARMENT, SUSPENSION, INELIGIBILITY AND VOLUNTARY EXCLUSION

This provision is applicable to all Federal-aid construction contracts, design-build contracts, subcontracts, lower-tier subcontracts, purchase orders, lease agreements, consultant contracts or any other covered transaction requiring FHWA approval or that is estimated to cost \$25,000 or more – as defined in 2 CFR Parts 180 and 1200. 2 CFR 180.220 and 1200.220.

1. Instructions for Certification – First Tier Participants:

a. By signing and submitting this proposal, the prospective first tier participant is providing the certification set out below.

b. The inability of a person to provide the certification set out below will not necessarily result in denial of participation in this covered transaction. The prospective first tier participant shall submit an explanation of why it cannot provide the certification set out below. The certification or explanation will be considered in connection with the department or agency's determination whether to enter into this transaction. However, failure of the prospective first tier participant to furnish a certification or an explanation shall disqualify such a person from participation in this transaction. 2 CFR 180.320.

c. The certification in this clause is a material representation of fact upon which reliance was placed when the contracting agency determined to enter into this transaction. If it is later determined that the prospective participant knowingly rendered an erroneous certification, in addition to other remedies available to the Federal Government, the contracting agency may terminate this transaction for cause of default. 2 CFR 180.325.

d. The prospective first tier participant shall provide immediate written notice to the contracting agency to whom this proposal is submitted if any time the prospective first tier participant learns that its certification was erroneous when submitted or has become erroneous by reason of changed circumstances. 2 CFR 180.345 and 180.350.

e. The terms "covered transaction," "debarred," "suspended," "ineligible," "participant," "person," "principal," and "voluntarily excluded," as used in this clause, are defined in 2 CFR Parts 180, Subpart I, 180.900-180.1020, and 1200. "First Tier Covered Transactions" refers to any covered transaction between a recipient or subrecipient of Federal funds and a participant (such as the prime or general contract). "Lower Tier Covered Transactions" refers to any covered transaction under a First Tier Covered Transaction (such as subcontracts). "First Tier Participant" refers to the participant who has entered into a covered transaction with a recipient or subrecipient of Federal funds (such as the prime or general contractor). "Lower Tier Participant" refers any participant who has entered into a covered transaction with a First Tier Participant or other Lower Tier Participants (such as subcontractors and suppliers).

f. The prospective first tier participant agrees by submitting this proposal that, should the proposed covered transaction be entered into, it shall not knowingly enter into any lower tier covered transaction with a person who is debarred, suspended, declared ineligible, or voluntarily excluded from participation in this covered transaction, unless authorized by the department or agency entering into this transaction. 2 CFR 180.330.

g. The prospective first tier participant further agrees by submitting this proposal that it will include the clause titled "Certification Regarding Debarment, Suspension, Ineligibility and Voluntary Exclusion-Lower Tier Covered Transactions," provided by the department or contracting agency, entering into this covered transaction, without modification, in all lower tier covered transactions and in all solicitations for lower tier covered transactions exceeding the \$25,000 threshold. 2 CFR 180.220 and 180.300.

h. A participant in a covered transaction may rely upon a certification of a prospective participant in a lower tier covered transaction that is not debarred, suspended, ineligible, or voluntarily excluded from the covered transaction, unless it knows that the certification is erroneous. 2 CFR 180.300; 180.320, and 180.325. A participant is responsible for ensuring that its principals are not suspended, debarred, or otherwise ineligible to participate in covered transactions. 2 CFR 180.335. To verify the eligibility of its principals, as well as the eligibility of any lower tier prospective participants, each participant may, but is not required to, check the System for Award Management website (<https://www.sam.gov>). 2 CFR 180.300, 180.320, and 180.325.

i. Nothing contained in the foregoing shall be construed to require the establishment of a system of records in order to render in good faith the certification required by this clause. The knowledge and information of the prospective participant is not required to exceed that which is normally possessed by a prudent person in the ordinary course of business dealings.

j. Except for transactions authorized under paragraph (f) of these instructions, if a participant in a covered transaction knowingly enters into a lower tier covered transaction with a person who is suspended, debarred, ineligible, or voluntarily excluded from participation in this transaction, in addition to other remedies available to the Federal Government, the department or agency may terminate this transaction for cause or default. 2 CFR 180.325.

* * * * *

2. Certification Regarding Debarment, Suspension, Ineligibility and Voluntary Exclusion – First Tier Participants:

a. The prospective first tier participant certifies to the best of its knowledge and belief, that it and its principals:

(1) Are not presently debarred, suspended, proposed for debarment, declared ineligible, or voluntarily excluded from participating in covered transactions by any Federal department or agency, 2 CFR 180.335;

(2) Have not within a three-year period preceding this proposal been convicted of or had a civil judgment rendered against them for commission of fraud or a criminal offense in connection with obtaining, attempting to obtain, or performing a public (Federal, State, or local) transaction or contract under a public transaction; violation of Federal or State antitrust statutes or commission of embezzlement, theft, forgery, bribery, falsification or destruction of records, making false statements, or receiving stolen property, 2 CFR 180.800;

(3) Are not presently indicted for or otherwise criminally or civilly charged by a governmental entity (Federal, State or local) with commission of any of the offenses enumerated in paragraph (a)(2) of this certification, 2 CFR 180.700 and 180.800; and

(4) Have not within a three-year period preceding this application/proposal had one or more public transactions (Federal, State or local) terminated for cause or default. 2 CFR 180.335(d).

(5) Are not a corporation that has been convicted of a felony violation under any Federal law within the two-year period preceding this proposal (USDOT Order 4200.6 implementing appropriations act requirements); and

(6) Are not a corporation with any unpaid Federal tax liability that has been assessed, for which all judicial and administrative remedies have been exhausted, or have lapsed, and that is not being paid in a timely manner pursuant to an agreement with the authority responsible for collecting the tax liability (USDOT Order 4200.6 implementing appropriations act requirements).

b. Where the prospective participant is unable to certify to any of the statements in this certification, such prospective participant should attach an explanation to this proposal. 2 CFR 180.335 and 180.340.

3. Instructions for Certification - Lower Tier Participants:

(Applicable to all subcontracts, purchase orders, and other lower tier transactions requiring prior FHWA approval or estimated to cost \$25,000 or more - 2 CFR Parts 180 and 1200). 2 CFR 180.220 and 1200.220.

a. By signing and submitting this proposal, the prospective lower tier participant is providing the certification set out below.

b. The certification in this clause is a material representation of fact upon which reliance was placed when this transaction was entered into. If it is later determined that the prospective lower tier participant knowingly rendered an erroneous certification, in addition to other remedies available to the Federal Government, the department, or agency with which this transaction originated may pursue available remedies, including suspension and/or debarment.

c. The prospective lower tier participant shall provide immediate written notice to the person to which this proposal is submitted if at any time the prospective lower tier participant learns that its certification was erroneous by reason of changed circumstances. 2 CFR 180.365.

d. The terms "covered transaction," "debarred," "suspended," "ineligible," "participant," "person," "principal," and "voluntarily excluded," as used in this clause, are defined in 2 CFR Parts 180, Subpart I, 180.900 – 180.1020, and 1200. You may contact the person to which this proposal is submitted for assistance in obtaining a copy of those regulations. "First Tier Covered Transactions" refers to any covered transaction between a recipient or subrecipient of Federal funds and a participant (such as the prime or general contract). "Lower Tier Covered Transactions" refers to any covered transaction under a First Tier Covered Transaction (such as subcontracts). "First Tier Participant" refers to the participant who has entered into a covered transaction with a recipient or subrecipient of Federal funds (such as the prime or general contractor). "Lower Tier Participant" refers any participant who has entered into a covered transaction with a First Tier Participant or other Lower Tier Participants (such as subcontractors and suppliers).

e. The prospective lower tier participant agrees by submitting this proposal that, should the proposed covered transaction be entered into, it shall not knowingly enter into any lower tier covered transaction with a person who is debarred, suspended, declared ineligible, or voluntarily excluded from participation in this covered transaction, unless authorized by the department or agency with which this transaction originated. 2 CFR 1200.220 and 1200.332.

f. The prospective lower tier participant further agrees by submitting this proposal that it will include this clause titled "Certification Regarding Debarment, Suspension, Ineligibility and Voluntary Exclusion-Lower Tier Covered Transaction," without modification, in all lower tier covered transactions and in all solicitations for lower tier covered transactions exceeding the \$25,000 threshold. 2 CFR 180.220 and 1200.220.

g. A participant in a covered transaction may rely upon a certification of a prospective participant in a lower tier covered transaction that is not debarred, suspended, ineligible, or voluntarily excluded from the covered transaction, unless it knows that the certification is erroneous. A participant is responsible for ensuring that its principals are not suspended, debarred, or otherwise ineligible to participate in covered transactions. To verify the eligibility of its principals, as well as the eligibility of any lower tier prospective participants, each participant may, but is not required to, check the System for Award Management website (<https://www.sam.gov/>), which is compiled by the General Services Administration. 2 CFR 180.300, 180.320, 180.330, and 180.335.

h. Nothing contained in the foregoing shall be construed to require establishment of a system of records in order to render in good faith the certification required by this clause. The knowledge and information of participant is not required to exceed that which is normally possessed by a prudent person in the ordinary course of business dealings.

i. Except for transactions authorized under paragraph e of these instructions, if a participant in a covered transaction knowingly enters into a lower tier covered transaction with a person who is suspended, debarred, ineligible, or voluntarily excluded from participation in this transaction, in addition to other remedies available to the Federal Government, the department or agency with which this transaction originated may pursue available remedies, including suspension and/or debarment. 2 CFR 180.325.

Certification Regarding Debarment, Suspension, Ineligibility and Voluntary Exclusion--Lower Tier Participants:

1. The prospective lower tier participant certifies, by submission of this proposal, that neither it nor its principals:

(a) is presently debarred, suspended, proposed for debarment, declared ineligible, or voluntarily excluded from participating in covered transactions by any Federal department or agency, 2 CFR 180.355;

(b) is a corporation that has been convicted of a felony violation under any Federal law within the two-year period preceding this proposal (USDOT Order 4200.6 implementing appropriations act requirements); and

(c) is a corporation with any unpaid Federal tax liability that has been assessed, for which all judicial and administrative remedies have been exhausted, or have lapsed, and that is not being paid in a timely manner pursuant to an agreement with the authority responsible for collecting the tax liability. (USDOT Order 4200.6 implementing appropriations act requirements)

2. Where the prospective lower tier participant is unable to certify to any of the statements in this certification, such prospective participant should attach an explanation to this proposal.

XI. CERTIFICATION REGARDING USE OF CONTRACT FUNDS FOR LOBBYING

This provision is applicable to all Federal-aid construction contracts and to all related subcontracts which exceed \$100,000. 49 CFR Part 20, App. A.

1. The prospective participant certifies, by signing and submitting this bid or proposal, to the best of his or her knowledge and belief, that:

a. No Federal appropriated funds have been paid or will be paid, by or on behalf of the undersigned, to any person for influencing or attempting to influence an officer or employee of any Federal agency, a Member of Congress, an officer or employee of Congress, or an employee of a Member of Congress in connection with the awarding of any Federal contract, the making of any Federal grant, the making of any Federal loan, the entering into of any cooperative agreement, and the extension, continuation, renewal, amendment, or modification of any Federal contract, grant, loan, or cooperative agreement.

b. If any funds other than Federal appropriated funds have been paid or will be paid to any person for influencing or attempting to influence an officer or employee of any Federal agency, a Member of Congress, an officer or employee of Congress, or an employee of a Member of Congress in connection with this Federal contract, grant, loan, or cooperative agreement, the undersigned shall complete and submit Standard Form-LLL, "Disclosure Form to Report Lobbying," in accordance with its instructions.

2. This certification is a material representation of fact upon which reliance was placed when this transaction was made or entered into. Submission of this certification is a prerequisite for making or entering into this transaction imposed by 31 U.S.C. 1352. Any person who fails to file the required certification shall be subject to a civil penalty of not less than \$10,000 and not more than \$100,000 for each such failure.

3. The prospective participant also agrees by submitting its bid or proposal that the participant shall require that the language of this certification be included in all lower tier subcontracts, which exceed \$100,000 and that all such recipients shall certify and disclose accordingly.

XII. USE OF UNITED STATES-FLAG VESSELS:

This provision is applicable to all Federal-aid construction contracts, design-build contracts, subcontracts, lower-tier subcontracts, purchase orders, lease agreements, or any other covered transaction. 46 CFR Part 381.

This requirement applies to material or equipment that is acquired for a specific Federal-aid highway project. 46 CFR 381.7. It is not applicable to goods or materials that come into inventories independent of an FHWA funded-contract.

When oceanic shipments (or shipments across the Great Lakes) are necessary for materials or equipment acquired for a specific Federal-aid construction project, the bidder, proposer, contractor, subcontractor, or vendor agrees:

1. To utilize privately owned United States-flag commercial vessels to ship at least 50 percent of the gross tonnage (computed separately for dry bulk carriers, dry cargo liners, and tankers) involved, whenever shipping any equipment, material, or commodities pursuant to this contract, to the extent such vessels are available at fair and reasonable rates for United States-flag commercial vessels. 46 CFR 381.7.

2. To furnish within 20 days following the date of loading for shipments originating within the United States or within 30 working days following the date of loading for shipments originating outside the United States, a legible copy of a rated, 'on-board' commercial ocean bill-of-lading in English for each shipment of cargo described in paragraph (b)(1) of this section to both the Contracting Officer (through the prime contractor in the case of subcontractor bills-of-lading) and to the Office of Cargo and Commercial Sealift (MAR-620), Maritime Administration, Washington, DC 20590. (MARAD requires copies of the ocean carrier's (master) bills of lading, certified onboard, dated, with rates and charges. These bills of lading may contain business sensitive information and therefore may be submitted directly to MARAD by the Ocean Transportation Intermediary on behalf of the contractor). 46 CFR 381.7.

12. FEMALE AND MINORITY GOALS

To comply with Section II, "Nondiscrimination," of "Required Contract Provisions Federal-Aid Construction Contracts," the following are for female and minority utilization goals for Federal-aid construction contracts and subcontracts that exceed \$10,000:

The nationwide goal for female utilization is 6.9 percent.

The goals for minority utilization (45 Fed Reg 65984 (10/3/1980)) are as follows:

MINORITY UTILIZATION GOALS

	Economic Area	Goal (Percent)
174	Redding CA: Non-SMSA (Standard Metropolitan Statistical Area) Counties: CA Lassen; CA Modoc; CA Plumas; CA Shasta; CA Siskiyou; CA Tehama	6.8
175	Eureka, CA Non-SMSA Counties: CA Del Norte; CA Humboldt; CA Trinity	6.6
176	San Francisco-Oakland-San Jose, CA: SMSA Counties: 7120 Salinas-Seaside-Monterey, CA CA Monterey	28.9
	7360 San Francisco-Oakland CA Alameda; CA Contra Costa; CA Marin; CA San Francisco; CA San Mateo	25.6
	7400 San Jose, CA CA Santa Clara, CA	19.6
	7485 Santa Cruz, CA CA Santa Cruz	14.9
	7500 Santa Rosa CA Sonoma	9.1
	8720 Vallejo-Fairfield-Napa, CA CA Napa; CA Solano	17.1
	Non-SMSA Counties: CA Lake; CA Mendocino; CA San Benito	23.2
177	Sacramento, CA: SMSA Counties: 6920 Sacramento, CA CA Placer; CA Sacramento; CA Yolo Non-SMSA Counties	16.1
	CA Butte; CA Colusa; CA El Dorado; CA Glenn; CA Nevada; CA Sierra; CA Sutter; CA Yuba	14.3
178	Stockton-Modesto, CA: SMSA Counties: 5170 Modesto, CA CA Stanislaus	12.3
	8120 Stockton, CA CA San Joaquin	24.3
	Non-SMSA Counties CA Alpine; CA Amador; CA Calaveras; CA Mariposa; CA Merced; CA Tuolumne	19.8
179	Fresno-Bakersfield, CA SMSA Counties: 0680 Bakersfield, CA CA Kern	19.1
	2840 Fresno, CA	26.1

	CA Fresno Non-SMSA Counties: CA Kings; CA Madera; CA Tulare	23.6
180	Los Angeles, CA: SMSA Counties: 0360 Anaheim-Santa Ana-Garden Grove, CA	11.9
	CA Orange	28.3
	4480 Los Angeles-Long Beach, CA	
	CA Los Angeles	21.5
	6000 Oxnard-Simi Valley-Ventura, CA	
	CA Ventura	19.0
	6780 Riverside-San Bernardino-Ontario, CA	
181	CA Riverside; CA San Bernardino	19.7
	7480 Santa Barbara-Santa Maria-Lompoc, CA	
	CA Santa Barbara	24.6
	Non-SMSA Counties	
	CA Inyo; CA Mono; CA San Luis Obispo	
	San Diego, CA: SMSA Counties	16.9
7320 San Diego, CA		
CA San Diego	18.2	
	Non-SMSA Counties	
	CA Imperial	

For the last full week of July during which work is performed under the contract, the prime contractor and each non material-supplier subcontractor with a subcontract of \$10,000 or more must complete Form FHWA PR-1391 (Appendix C to 23 CFR 230). Submit the forms by August 15.

13. TITLE VI ASSURANCES

The U.S. Department of Transportation Order No.1050.2A requires all federal-aid Department of Transportation contracts between an agency and a contractor to contain Appendix A and E. Appendix B only requires inclusion if the contract impacts deeds effecting or recording the transfer of real property, structures, or improvements thereon, or granting interest therein. Appendices C and D only require inclusion if the contract impacts deeds, licenses, leases, permits, or similar instruments entered into by the recipient.

APPENDIX A

During the performance of this Agreement, the contractor, for itself, its assignees and successors in interest (hereinafter collectively referred to as CONTRACTOR) agrees as follows:

- a. Compliance with Regulations: CONTRACTOR shall comply with the regulations relative to nondiscrimination in federally assisted programs of the Department of Transportation, Title 49, Code of Federal Regulations, Part 21, as they may be amended from time to time, (hereinafter referred to as the REGULATIONS), which are herein incorporated by reference and made a part of this agreement.
- b. Nondiscrimination: CONTRACTOR, with regard to the work performed by it during the AGREEMENT, shall not discriminate on the grounds of race, color, sex, national origin, religion, age, or disability in the selection and retention of sub-applicants, including procurements of materials and leases of equipment. CONTRACTOR shall not participate either directly or indirectly in the discrimination prohibited by Section 21.5 of the Regulations, including employment practices when the agreement covers a program set forth in Appendix B of the Regulations.
- c. Solicitations for Sub-agreements, Including Procurements of Materials and Equipment: In all solicitations either by competitive bidding or negotiation made by CONTRACTOR for work to be performed under a Sub- agreement, including procurements of materials or leases of equipment,

each potential sub-applicant or supplier shall be notified by CONTRACTOR of the CONTRACTOR'S obligations under this Agreement and the Regulations relative to nondiscrimination on the grounds of race, color, or national origin.

- d. Information and Reports: CONTRACTOR shall provide all information and reports required by the Regulations, or directives issued pursuant thereto, and shall permit access to its books, records, accounts, other sources of information, and its facilities as may be determined by the recipient or FHWA to be pertinent to ascertain compliance with such Regulations or directives. Where any information required of CONTRACTOR is in the exclusive possession of another who fails or refuses to furnish this information, CONTRACTOR shall so certify to the recipient or FHWA as appropriate, and shall set forth what efforts CONTRACTOR has made to obtain the information.
- e. Sanctions for Noncompliance: In the event of CONTRACTOR's noncompliance with the nondiscrimination provisions of this agreement, the recipient shall impose such agreement sanctions as it or the FHWA may determine to be appropriate, including, but not limited to:
 - i. withholding of payments to CONTRACTOR under the Agreement within a reasonable period of time, not to exceed 90 days; and/or
 - ii. cancellation, termination or suspension of the Agreement, in whole or in part.
- f. Incorporation of Provisions: CONTRACTOR shall include the provisions of paragraphs (1) through (6) in every sub-agreement, including procurements of materials and leases of equipment, unless exempt by the Regulations, or directives issued pursuant thereto.

CONTRACTOR shall take such action with respect to any sub-agreement or procurement as the recipient or FHWA may direct as a means of enforcing such provisions including sanctions for noncompliance, provided, however, that, in the event CONTRACTOR becomes involved in, or is threatened with, litigation with a sub-applicant or supplier as a result of such direction, CONTRACTOR may request the recipient enter into such litigation to protect the interests of the State, and, in addition, CONTRACTOR may request the United States to enter into such litigation to protect the interests of the United States.

APPENDIX B

CLAUSES FOR DEEDS TRANSFERRING UNITED STATES PROPERTY

The following clauses will be included in deeds effecting or recording the transfer of real property, structures, or improvements thereon, or granting interest therein from the United States pursuant to the provisions of Assurance 4:

NOW THEREFORE, the U.S. Department of Transportation as authorized by law and upon the condition that the recipient will accept title to the lands and maintain the project constructed thereon in accordance with Title 23 U.S.C., the regulations for the administration of the preceding statute, and the policies and procedures prescribed by the FHWA of the U.S. Department of Transportation in accordance and in compliance with all requirements imposed by Title 49, Code of Federal Regulations, U.S. Department of Transportation, Subtitle A, Office of the Secretary, Part 21, Non-discrimination in Federally-assisted programs of the U.S. Department of Transportation pertaining to and effectuating the provisions of Title VI of the Civil Rights Act of 1964 (78 Stat. 252; 42 U.S.C. § 2000d to 2000d-4), does hereby remise, release, quitclaim and convey unto the recipient all the right, title and interest of the U.S. Department of Transportation in and to said lands described in Exhibit A attached hereto and made a part hereof.

(HABENDUM CLAUSE)

TO HAVE AND TO HOLD said lands and interests therein unto the recipient and its successors forever, subject, however, to the covenants, conditions, restrictions and reservations herein contained as follows, which will remain in effect for the period during which the real property or structures are used for a purpose for which Federal financial assistance is extended or for another purpose involving the provision of similar services or benefits and will be binding on the recipient, its successors and assigns. The recipient, in consideration of the conveyance of said lands and interest in lands, does hereby covenant and agree as a covenant running with the land for itself, its successors and assigns, that (1) no person

will on the grounds of race, color, or national origin, be excluded from participation in, be denied the benefits of, or be otherwise subjected to discrimination with regard to any facility located wholly or in part on, over, or under such lands hereby conveyed [,] [and]* (2) that the recipient will use the lands and interests in lands and interest in lands so conveyed, in compliance with all requirements imposed by or pursuant to Title 49, Code of Federal Regulations, U.S. Department of Transportation, Subtitle A, Office of the Secretary, Part 21, Non-discrimination in Federally-assisted programs of the U.S. Department of Transportation, Effectuation of Title VI of the Civil Rights Act of 1964, and as said Regulations and Acts may be amended[, and (3) that in the event of breach of any of the above-mentioned non-discrimination conditions, the Department will have a right to enter or re-enter said lands and facilities on said lands, and that above described land and facilities will thereon revert to and vest in and become the absolute property of the U.S. Department of Transportation and its assigns as such interest existed prior to this instruction].*

(*Reverter clause and related language to be used only when it is determined that such a clause is necessary in order to make clear the purpose of Title VI.)

APPENDIX C

CLAUSES FOR TRANSFER OF REAL PROPERTY ACQUIRED OR IMPROVED UNDER THE ACTIVITY, FACILITY, OR PROGRAM

The following clauses will be included in deeds, licenses, leases, permits, or similar instruments entered into by the recipient pursuant to the provisions of Assurance 7(a):

A. The (grantee, lessee, permittee, etc. as appropriate) for himself/herself, his/her heirs, personal representatives, successors in interest, and assigns, as a part of the consideration hereof, does hereby covenant and agree [in the case of deeds and leases add "as a covenant running with the land"] that:

1. In the event facilities are constructed, maintained, or otherwise operated on the property described in this (deed, license, lease, permit, etc.) for a purpose for which a U.S. Department of Transportation activity, facility, or program is extended or for another purpose involving the provision of similar services or benefits, the (grantee, licensee, lessee, permittee, etc.) will maintain and operate such facilities and services in compliance with all requirements imposed by the Acts and Regulations (as may be amended) such that no person on the grounds of race, color, or national origin, will be excluded from participation in, denied the benefits of, or be otherwise subjected to discrimination in the use of said facilities.

B. With respect to licenses, leases, permits, etc., in the event of breach of any of the above Non-discrimination covenants, the recipient will have the right to terminate the (lease, license, permit, etc.) and to enter, re-enter, and repossess said lands and facilities thereon, and hold the same as if the (lease, license, permit, etc.) had never been made or issued.*

C. With respect to a deed, in the event of breach of any of the above Non-discrimination covenants, the recipient will have the right to enter or re-enter the lands and facilities thereon, and the above described lands and facilities will there upon revert to and vest in and become the absolute property of the recipient and its assigns.*

(*Reverter clause and related language to be used only when it is determined that such a clause is necessary to make clear the purpose of Title VI.)

APPENDIX D

CLAUSES FOR CONSTRUCTION/USE/ACCESS TO REAL PROPERTY ACQUIRED UNDER THE ACTIVITY, FACILITY OR PROGRAM

The following clauses will be included in deeds, licenses, permits, or similar instruments/agreements entered into by the recipient pursuant to the provisions of Assurance 7(b):

A. The (grantee, licensee, permittee, etc., as appropriate) for himself/herself, his/her heirs, personal representatives, successors in interest, and assigns, as a part of the consideration hereof, does hereby covenant and agree (in the case of deeds and leases add, "as a covenant running with the land") that (1) no person on the ground of race, color, or national origin, will be excluded from participation in, denied the benefits of, or be otherwise subjected to discrimination in the use of said facilities, (2) that in the construction of any improvements on, over, or under such land, and the furnishings of services thereon, no person on the ground of race, color, or national origin, will be excluded from participation in, denied the benefits or, or otherwise be subjected to discrimination, (3) that the (grantee, licensee, lessee, permittee, etc.) will use the premises in compliance with all other requirements imposed by or pursuant to the Acts and Regulations, as amended, set forth in this Assurance.

B. With respect to (licenses, leases, permits, etc.) in the event of breach of any of the above of the above Non-discrimination covenants, the recipient will have the right to terminate the (license, permits, etc., as appropriate) and to enter or re-enter and repossess said land and the facilities thereon, and hold the same as if said (license, permit, etc., as appropriate) had never been made or issued.*

C. With respect to deeds, in the event of breach of any of the above Non-discrimination covenants, the recipient will there upon revert to and vest in and become the absolute property of the recipient and its assigns.

(*Reverter clause and related language to be used only when it is determined that such a clause is necessary to make clear the purpose of Title VI.)

APPENDIX E

During the performance of this contract, the contractor, for itself, its assignees, and successors in interest (hereinafter referred to as the "contractor") agrees to comply with the following non-discrimination statutes and authorities, including, but not limited to:

Pertinent Non-Discrimination Authorities:

- Title VI of the Civil Rights Act of 1964 (42 U.S.C. § 2000d et seq., 78 stat. 252), prohibits discrimination on the basis of race, color, national origin); and 49 CFR Part 21.
- The Uniform Relocation Assistance and Real Property Acquisition Policies Act of 1970, (42 U.S.C. § 4601), (prohibits unfair treatment of persons displaced or whose property has been acquired because of Federal or Federal-aid programs and projects);
- Federal-Aid Highway Act of 1973, (23 U.S.C. § 324 et seq.), prohibits discrimination on the basis of sex;
- Section 504 of the Rehabilitation Act of 1973, (29 U.S.C. § 794 et seq.), as amended, (prohibits discrimination on the basis of disability); and 49 CR Part 27;
- The Age Discrimination Act of 1975, as amended, (42 U.S.C. § 6101 et seq.), prohibits discrimination on the basis of age);
- Airport and Airway Improvement Act of 1982, (49 U.S.C. § 471, Section 47123), as amended, (prohibits discrimination based on race, creed, color, national origin, or sex);
- The Civil Rights Restoration Act of 1987, (PL 100-209), (Broadened the scope, coverage and applicability of Title VI of the Civil Rights Act of 1964, The Age Discrimination Act of 1975 and Section 504 of the Rehabilitation Act of 1973, by expanding the definition of the terms "programs or activities" to include all of the programs or activities of the Federal-aid recipients, sub-recipients and contractors, whether such programs or activities are Federally funded or not);

-
- Titles II and III of the Americans with Disabilities Act, which prohibit discrimination on the basis of disability in the operation of public entities, public and private transportation systems, places of public accommodation, and certain testing entities (42 U.S.C. §§ 12131 – 12189) as implemented by Department of Transportation regulations 49 C.F.R. parts 37 and 38;
 - The Federal Aviation Administration’s Non-discrimination statute (49 U.S.C. § 47123) (prohibits discrimination on the basis of race, color, national origin, and sex);
 - Executive Order 12898, Federal Actions to Address Environmental Justice in Minority Populations and Low-Income Populations, which ensures discrimination against minority populations by discouraging programs, policies, and activities with disproportionately high and adverse human health or environmental effects on minority and low-income populations;
 - Executive Order 13166, Improving Access to Services for Persons with Limited English Proficiency, and resulting agency guidance, national origin discrimination includes discrimination because of limited English proficiency (LEP). To ensure compliance with Title VI, you must take reasonable steps to ensure that LEP persons have meaningful access to your programs (70 Fed. Reg. at 74087 to 74100);
 - Title IX of the Education Amendments of 1972, as amended, which prohibits you from discriminating because of sex in education programs or activities (20 U.S.C. 1681 et seq).

Federal Trainee Program Special Provisions
(to be used when applicable)

14. FEDERAL TRAINEE PROGRAM

For the Federal training program, the number of trainees or apprentices is ____.

This section applies if a number of trainees or apprentices is specified in the special provisions.

As part of the prime contractor's equal opportunity affirmative action program, provide on-the-job training to develop full journeymen in the types of trades or job classifications involved.

The prime contractor has primary responsibility for meeting this training requirement.

If the prime contractor subcontracts a contract part, they shall determine how many trainees or apprentices are to be trained by the subcontractor. Include these training requirements in each subcontract.

Where feasible, 25 percent of apprentices or trainees in each occupation must be in their 1st year of apprenticeship or training.

Distribute the number of apprentices or trainees among the work classifications on the basis of the prime contractor's needs and the availability of journeymen in the various classifications within a reasonable recruitment area.

Before starting work, the prime contractor shall submit to the City/County of _____ :

1. Number of apprentices or trainees to be trained for each classification
2. Training program to be used
3. Training starting date for each classification

The prime contractor shall obtain the City/County of _____ approval for this submitted information before the prime contractor starts work. The City/County of _____ credits the prime contractor for each apprentice or trainee the prime contractor employs on the job who is currently enrolled or becomes enrolled in an approved program.

The primary objective of this section is to train and upgrade minorities and women toward journeyman status. The prime contractor shall make every effort to enroll minority and women apprentices or trainees, such as conducting systematic and direct recruitment through public and private sources likely to yield minority and women apprentices or trainees, to the extent they are available within a reasonable recruitment area and show that they have made the efforts. In making these efforts, the prime contractor shall not discriminate against any applicant for training.

The prime contractor shall not employ as an apprentice or trainee an employee:

1. In any classification in which the employee has successfully completed a training course leading to journeyman status or in which the employee has been employed as a journeyman
2. Who is not registered in a program approved by the US Department of Labor, Bureau of Apprenticeship and Training

The prime contractor shall ask the employee if the employee has successfully completed a training course leading to journeyman status or has been employed as a journeyman. The prime contractor's records must show the employee's answers to the questions.

In the training program, the prime contractor shall establish the minimum length and training type for each classification. The City/County of _____ and FHWA approves a program if one of the following is met:

1. It is calculated to:
 - Meet the equal employment opportunity responsibilities
 - Qualify the average apprentice or trainee for journeyman status in the classification involved by the end of the training period
2. It is registered with the U.S. Department of Labor, Bureau of Apprenticeship and Training, and it is administered in a way consistent with the equal employment responsibilities of Federal-aid highway construction contracts

The prime contractor shall obtain the State's approval for their training program before they start work involving the classification covered by the program.

The prime contractor shall provide training in the construction crafts, not in clerk-typist or secretarial-type positions. Training is allowed in lower level management positions such as office engineers, estimators, and timekeepers if the training is oriented toward construction applications. Training is allowed in the laborer classification if significant and meaningful training is provided and approved by the division office. Off-site training is allowed if the training is an integral part of an approved training program and does not make up a significant part of the overall training.

The City/County of _____ reimburses the prime contractor 80 cents per hour of training given an employee on this contract under an approved training program:

1. For on-site training
2. For off-site training if the apprentice or trainee is currently employed on a Federal-aid project and prime contractor does at least one of the following:
 - a. Contribute to the cost of the training
 - b. Provide the instruction to the apprentice or trainee
 - c. Pay the apprentice's or trainee's wages during the off-site training period
3. If the prime contractor complies with this section.

Each apprentice or trainee must:

1. Begin training on the project as soon as feasible after the start of work involving the apprentice's or trainee's skill
2. Remain on the project as long as training opportunities exist in the apprentice's or trainee's work classification or until the apprentice or trainee has completed the training program

The prime contractor shall furnish the apprentice or trainee with a copy of the program that the prime contractor will comply with in providing the training.

15. PROHIBITION OF CERTAIN TELECOMMUNICATIONS AND VIDEO SURVEILLANCE EQUIPMENT AND SERVICES

In response to significant national security concerns, the agency shall check the prohibited vendor list before making any telecommunications and video surveillance purchase because recipients and subrecipients of federal funds are prohibited from obligating or expending loan or grant funds to:

- Procure or obtain;
- Extend or renew a contract to procure or obtain; or
- Enter into a contract (or extend or renew a contract) to procure or obtain equipment, services, or systems that uses covered telecommunications equipment or services as a substantial or essential component of any system, or as critical technology as part of any system.

The prohibited vendors (and their subsidiaries or affiliates) are:

- Huawei Technologies Company;
- ZTE Corporation;
- Hytera Communications Corporation;
- Hangzhou Hikvision Digital Technology Company;
- Dahua Technology Company; and
- Subsidiaries or affiliates of the above-mentioned companies.

In implementing the prohibition, the agency administering loan, grant, or subsidy programs shall prioritize available funding and technical support to assist affected businesses, institutions and organizations as is reasonably necessary for those affected entities to transition from covered communications equipment and services, to procure replacement equipment and services, and to ensure that communications service to users and customers is sustained.

The contractors should furnish telecommunications and video surveillance equipment with a certificate of compliance. The certificate must state telecommunications and video surveillance equipment was not procured or obtained from manufacturers identified in the above list.

EXHIBIT 12-B

Exhibit 12-B: Bidder's List of Subcontractor (DBE and Non-DBE) - Part 1

As of March 1, 2015 Contractors (and sub-contractors) wishing to bid on public works contracts must be registered with the State Division of Industrial Relations and certified to bid on Public Works contracts. Please register at <https://www.dir.ca.gov/Public-Works/Contractor-Registration.html>. The local agency will verify registration of all contractors and subcontractors on public works projects at bid and thereafter annually to assure that yearly registration is maintained throughout the life of the project.

In accordance with Title 49, Section 26.11 of the Code of Federal Regulations, and Section 4104 of the Public Contract Code of the State of California, as amended, the following information is required for each sub-contractor who will perform work amounting to more than one half of one percent (0.5%) of the Total Base Bid or \$10,000 (whichever is greater).

FEDERAL PROJECT NUMBER:

Photocopy this form for additional firms.

Subcontractor Name & Location	Line Item & Description	Subcontract Amount	Percentage of Bid Item Subcontracted	Contractor License Number	DBE (Y/N)	DBE Cert Number	Annual Gross Receipts	
				DIR Reg Number				
NAME								< \$1 million
								< \$5 million
								< \$10 million
City, State								< \$15 million
							Age of Firm in years	
NAME								< \$1 million
								< \$5 million
								< \$10 million
City, State								< \$15 million
							Age of Firm in years	
NAME								< \$1 million
								< \$5 million
								< \$10 million
City, State								< \$15 million
							Age of Firm in years	
NAME								< \$1 million
								< \$5 million
								< \$10 million
City, State								< \$15 million
							Age of Firm in years	
NAME								< \$1 million
								< \$5 million
								< \$10 million
City, State								< \$15 million
							Age of Firm in years	
NAME								< \$1 million
								< \$5 million
								< \$10 million
City, State								< \$15 million
							Age of Firm in years	
NAME								< \$1 million
								< \$5 million
								< \$10 million
City, State								< \$15 million
							Age of Firm in years	
NAME								< \$1 million
								< \$5 million
								< \$10 million
City, State								< \$15 million
							Age of Firm in years	

Exhibit 12-B: Bidder's List of Subcontractor (DBE and Non-DBE) - Part 2

In accordance with Title 49, Section 26 of the Code of Federal Regulations, the Bidder shall list all subcontractors who provided a quote or bid but **were not selected** to participate as a subcontractor on this project.

FEDERAL PROJECT NUMBER:

Photocopy this form for additional firms.

Subcontractor Name & Location	Line Item & Description	Subcontract Amount	Percentage of Bid Item Subcontracted	Contractor License Number	DBE (Y/N)	DBE Cert Number	Annual Gross Receipts	
				DIR Reg Number				
NAME							< \$1 million	
							< \$5 million	
							< \$10 million	
City, State							< \$15 million	
							Age of Firm in years	
NAME							< \$1 million	
							< \$5 million	
							< \$10 million	
City, State							< \$15 million	
							Age of Firm in years	
NAME							< \$1 million	
							< \$5 million	
							< \$10 million	
City, State							< \$15 million	
							Age of Firm in years	
NAME							< \$1 million	
							< \$5 million	
							< \$10 million	
City, State							< \$15 million	
							Age of Firm in years	
NAME							< \$1 million	
							< \$5 million	
							< \$10 million	
City, State							< \$15 million	
							Age of Firm in years	
NAME							< \$1 million	
							< \$5 million	
							< \$10 million	
City, State							< \$15 million	
							Age of Firm in years	
NAME							< \$1 million	
							< \$5 million	
							< \$10 million	
City, State							< \$15 million	
							Age of Firm in years	
NAME							< \$1 million	
							< \$5 million	
							< \$10 million	
City, State							< \$15 million	
							Age of Firm in years	

EXHIBIT 15-G

EXHIBIT 15-G CONSTRUCTION CONTRACT DBE COMMITMENT

1. Local Agency: _____ 2. Contract DBE Goal: _____
3. Project Description: _____
4. Project Location: _____
5. Bidder's Name: _____ 6. Prime Certified DBE: 7. Bid Amount: _____
8. Total Dollar Amount for **ALL** Subcontractors: _____ 9. Total Number of **ALL** Subcontractors: _____

10. Bid Item Number	11. Description of Work, Service, or Materials Supplied	12. DBE Certification Number	13. DBE Contact Information (Must be certified on the date bids are opened)	14. DBE Dollar Amount

Local Agency to Complete this Section upon Execution of Award		15. TOTAL CLAIMED DBE PARTICIPATION	%		
21. Local Agency Contract Number: _____	22. Federal-Aid Project Number: _____				
23. Bid Opening Date: _____	24. Contract Award Date: _____	IMPORTANT: Identify all DBE firms being claimed for credit, regardless of tier. Names of the First Tier DBE Subcontractors and their respective item(s) of work listed above must be consistent, where applicable with the names and items of the work in the "Subcontractor List" submitted with your bid. Written confirmation of each listed DBE is required.			
25. Award Amount: _____	Local Agency certifies that all DBE certifications are valid and information on this form is complete and accurate.				
26. Local Agency Representative's Signature _____	27. Date _____			16. Preparer's Signature _____	17. Date _____
28. Local Agency Representative's Name _____	29. Phone _____			18. Preparer's Name _____	19. Phone _____
30. Local Agency Representative's Title _____	20. Preparer's Title _____				

- DISTRIBUTION: 1. Original – Local Agency
 2. Copy – Caltrans District Local Assistance Engineer (DLAE). Failure to submit to DLAE within 30 days of contract execution may result in de-obligation of federal funds on contract.
 3. Include additional copy with award package.

ADA Notice: For individuals with sensory disabilities, this document is available in alternate formats. For information call (916) 654-6410 or TDD (916) 654-3880 or write Records and Forms Management, 1120 N Street, MS-89, Sacramento, CA 95814.

INSTRUCTIONS – CONSTRUCTION CONTRACT DBE COMMITMENT

CONTRACTOR SECTION

- 1. Local Agency** - Enter the name of the local agency that is administering the contract.
- 2. Contract DBE Goal** - Enter the contract DBE goal percentage as it appears on the project advertisement.
- 3. Project Location** - Enter the project location(s) as it appears on the project advertisement.
- 4. Project Description** - Enter the project description as it appears on the project advertisement (Bridge Rehab, Seismic Rehab, Overlay, Widening, etc).
- 5. Bidder's Name** - Enter the contractor's firm name.
- 6. Prime Certified DBE** - Check box if prime contractor is a certified DBE.
- 7. Bid Amount** - Enter the total contract bid dollar amount for the prime contractor.
- 8. Total Dollar Amount for ALL Subcontractors** – Enter the total dollar amount for all subcontracted contractors. SUM = (DBEs + all Non-DBEs). Do not include the prime contractor information in this count.
- 9. Total number of ALL subcontractors** – Enter the total number of all subcontracted contractors. SUM = (DBEs + all Non-DBEs). Do not include the prime contractor information in this count.
- 10. Bid Item Number** - Enter bid item number for work, services, or materials supplied to be provided.
- 11. Description of Work, Services, or Materials Supplied** - Enter description of work, services, or materials to be provided. Indicate all work to be performed by DBEs including work performed by the prime contractor's own forces, if the prime is a DBE. If 100% of the item is not to be performed or furnished by the DBE, describe the exact portion to be performed or furnished by the DBE. See LAPM Chapter 9 to determine how to count the participation of DBE firms.
- 12. DBE Certification Number** - Enter the DBE's Certification Identification Number. All DBEs must be certified on the date bids are opened.
- 13. DBE Contact Information** - Enter the name, address, and phone number of all DBE subcontracted contractors. Also, enter the prime contractor's name and phone number, if the prime is a DBE.
- 14. DBE Dollar Amount** - Enter the subcontracted dollar amount of the work to be performed or service to be provided. Include the prime contractor if the prime is a DBE. See LAPM Chapter 9 for how to count full/partial participation.
- 15. Total Claimed DBE Participation** - \$: Enter the total dollar amounts entered in the "DBE Dollar Amount" column. %: Enter the total DBE participation claimed ("Total Claimed DBE Participation Dollars" divided by item "Bid Amount"). If the total % claimed is less than item "Contract DBE Goal," an adequately documented Good Faith Effort (GFE) is required (see Exhibit 15-H DBE Information - Good Faith Efforts of the LAPM).
- 16. Preparer's Signature** - The person completing the DBE commitment form on behalf of the contractor's firm must sign their name.
- 17. Date** - Enter the date the DBE commitment form is signed by the contractor's preparer.
- 18. Preparer's Name** - Enter the name of the person preparing and signing the contractor's DBE commitment form.
- 19. Phone** - Enter the area code and phone number of the person signing the contractor's DBE commitment form.
- 20. Preparer's Title** - Enter the position/title of the person signing the contractor's DBE commitment form.

LOCAL AGENCY SECTION

- 21. Local Agency Contract Number** - Enter the Local Agency contract number or identifier.
- 22. Federal-Aid Project Number** - Enter the Federal-Aid Project Number(s).
- 23. Bid Opening Date** - Enter the date contract bids were opened.
- 24. Contract Award Date** - Enter the date the contract was executed.
- 25. Award Amount** – Enter the contract award amount as stated in the executed contract.
- 26. Local Agency Representative's Signature** - The person completing this section of the form for the Local Agency must sign their name to certify that the information in this and the Contractor Section of this form is complete and accurate.
- 27. Date** - Enter the date the DBE commitment form is signed by the Local Agency Representative.
- 28. Local Agency Representative's Name** - Enter the name of the Local Agency Representative certifying the contractor's DBE commitment form.
- 29. Phone** - Enter the area code and phone number of the person signing the contractor's DBE commitment form.

30. Local Agency Representative Title - Enter the position/title of the Local Agency Representative certifying the contractor's DBE commitment form.

EXHIBIT 15-H

EXHIBIT 15-H: PROPOSER/CONTRACTOR GOOD FAITH EFFORTS

Cost Proposal Due Date _____ PE/CE

Federal-aid Project No(s). _____ Bid Opening Date _____ CON

The _____ established a Disadvantaged Business Enterprise (DBE) goal of _____ for this contract. The information provided herein shows the required good faith efforts to meet or exceed the DBE contract goal.

Proposers or bidders submit the following information to document their good faith efforts within five (5) calendar days from cost proposal due date or bid opening. Proposers and bidders are recommended to submit the following information even if the Exhibit 10-O1: Consultant Proposal DBE Commitments or Exhibit 15-G: Construction Contract DBE Commitment indicate that the proposer or bidder has met the DBE goal. This form protects the proposer’s or bidder’s eligibility for award of the contract if the administering agency determines that the bidder failed to meet the goal for various reasons, e.g., a DBE firm was not certified at bid opening, or the bidder made a mathematical error.

The following items are listed in the Section entitled “Submission of DBE Commitment” of the Special Provisions, **please attach additional sheets as needed:**

- A. The names and dates of each publication in which a request for DBE participation for this project was placed by the bidder (please attach copies of advertisements or proofs of publication):

Publications	Dates of Advertisement

- B. The names and dates of written notices sent to certified DBEs soliciting bids for this project and the dates and methods used for following up initial solicitations to determine with certainty whether the DBEs were interested (please attach copies of solicitations, telephone records, fax confirmations, etc.):

Names of DBEs Solicited	Date of Initial Solicitation	Follow Up Methods and Dates

- C. The items of work made available to DBE firms including those unbundled contract work items into economically feasible units to facilitate DBE participation. It is the bidder's responsibility to demonstrate that sufficient work to facilitate DBE participation in order to meet or exceed the DBE contract goal.

Items of Work	Proposer or Bidder Normally Performs Item (Y/N)	Breakdown of Items	Amount (\$)	Percentage Of Contract
---------------	---	--------------------	-------------	------------------------

- D. The names, addresses and phone numbers of rejected DBE firms, the reasons for the bidder's rejection of the DBEs, the firms selected for that work (please attach copies of quotes from the firms involved), and the price difference for each DBE if the selected firm is not a DBE:

Names, addresses and phone numbers of rejected DBEs and the reasons for the bidder's rejection of the DBEs:

Names, addresses and phone numbers of firms selected for the work above:

- E. Efforts (e.g. in advertisements and solicitations) made to assist interested DBEs in obtaining information related to the plans, specifications and requirements for the work which was provided to DBEs:

F. Efforts (e.g. in advertisements and solicitations) made to assist interested DBEs in obtaining bonding, lines of credit or insurance, necessary equipment, supplies, materials, or related assistance or services, excluding supplies and equipment the DBE subcontractor purchases or leases from the prime contractor or its affiliate:

G. The names of agencies, organizations or groups contacted to provide assistance in contacting, recruiting and using DBE firms (please attach copies of requests to agencies and any responses received, i.e., lists, Internet page download, etc.):

Name of Agency/Organization	Method/Date of Contact	Results

H. Any additional data to support a demonstration of good faith efforts:

APPENDIX G

VENDOR APPLICATION FORM



City of Mission Viejo

200 Civic Center
Mission Viejo, CA 92691
Phone (949) 470-3059

purchasing@cityofmissionviejo.org

Vendor Approval Application

Please type or print in black ink. All vendor information must be complete and application must be signed. A signed Form W-9 must accompany this application.

Name of City Employee requesting this information: _____

Business Information:

*Company Name _____

*Address _____ *Suite _____

*City _____ *State _____ *Zip _____

*Contact Name/Title _____ Email _____

*Phone () _____ *Website _____

Accts Receivable Contact Name _____ E-Mail _____

*Remit Address _____ *State _____ *Zip _____

Accts Receivable Phone _____

Where is your DBA registered? _____

Year Established _____ Incorporated: Year _____ State _____

Product or Services provided _____

Standard Terms:

Net 30 2% 10 Net 30 Other _____

Current California License or Certifications(s) *(Examples: Contractor, Instructors, Health Dept, Architectural, Sports/Fitness, etc.):*

Type _____ Number _____

Type _____ Number _____

Type _____ Number _____

DIR Registration *(if applicable)* _____ Number _____

Company Ownership:

Sole Proprietorship Partnership Corporation Other *(please indicate)* _____

*Information is subject to disclosure under the Public Record Act

Principal Ownership or Corporate Officers:

Name _____ Title _____

Name _____ Title _____

Name _____ Title _____

References:

Please list three companies with whom you are currently doing business

Company Name _____ Phone (_____) _____

Address _____ Suite _____

City _____ State _____ Zip _____

Company Name _____ Phone (_____) _____

Address _____ Suite _____

City _____ State _____ Zip _____

Company Name _____ Phone (_____) _____

Address _____ Suite _____

City _____ State _____ Zip _____

Do you have a relationship with any existing City of Mission Viejo employee, Commissioner, Council member or Board member? YES NO If yes, please describe relationship below:

Certification:

Under penalty of perjury, I certify that all information provided on this application is true and correct.

Signature of Company Officer _____ Title _____

Please Print Name _____ Date _____

APPENDIX H

W9 REQUEST FOR TAXPAYER

Request for Taxpayer Identification Number and Certification

Give Form to the requester. Do not send to the IRS.

▶ Go to www.irs.gov/FormW9 for instructions and the latest information.

Print or type. See Specific Instructions on page 3.	1 Name (as shown on your income tax return). Name is required on this line; do not leave this line blank.	
	2 Business name/disregarded entity name, if different from above	
	3 Check appropriate box for federal tax classification of the person whose name is entered on line 1. Check only one of the following seven boxes. <div style="display: flex; justify-content: space-between; margin-top: 5px;"> <div style="width: 45%;"> <input type="checkbox"/> Individual/sole proprietor or single-member LLC <input type="checkbox"/> Limited liability company. Enter the tax classification (C=C corporation, S=S corporation, P=Partnership) ▶ _____ Note: Check the appropriate box in the line above for the tax classification of the single-member owner. Do not check LLC if the LLC is classified as a single-member LLC that is disregarded from the owner unless the owner of the LLC is another LLC that is not disregarded from the owner for U.S. federal tax purposes. Otherwise, a single-member LLC that is disregarded from the owner should check the appropriate box for the tax classification of its owner. <input type="checkbox"/> Other (see instructions) ▶ _____ </div> <div style="width: 45%;"> <input type="checkbox"/> C Corporation <input type="checkbox"/> S Corporation <input type="checkbox"/> Partnership <input type="checkbox"/> Trust/estate </div> </div>	4 Exemptions (codes apply only to certain entities, not individuals; see instructions on page 3): Exempt payee code (if any) _____ Exemption from FATCA reporting code (if any) _____ <small>(Applies to accounts maintained outside the U.S.)</small>
	5 Address (number, street, and apt. or suite no.) See instructions.	Requester's name and address (optional)
6 City, state, and ZIP code	7 List account number(s) here (optional)	

Part I Taxpayer Identification Number (TIN)

Enter your TIN in the appropriate box. The TIN provided must match the name given on line 1 to avoid backup withholding. For individuals, this is generally your social security number (SSN). However, for a resident alien, sole proprietor, or disregarded entity, see the instructions for Part I, later. For other entities, it is your employer identification number (EIN). If you do not have a number, see *How to get a TIN*, later.

Note: If the account is in more than one name, see the instructions for line 1. Also see *What Name and Number To Give the Requester* for guidelines on whose number to enter.

Social security number									
				-			-		
or									
Employer identification number									
				-					

Part II Certification

Under penalties of perjury, I certify that:

1. The number shown on this form is my correct taxpayer identification number (or I am waiting for a number to be issued to me); and
2. I am not subject to backup withholding because: (a) I am exempt from backup withholding, or (b) I have not been notified by the Internal Revenue Service (IRS) that I am subject to backup withholding as a result of a failure to report all interest or dividends, or (c) the IRS has notified me that I am no longer subject to backup withholding; and
3. I am a U.S. citizen or other U.S. person (defined below); and
4. The FATCA code(s) entered on this form (if any) indicating that I am exempt from FATCA reporting is correct.

Certification instructions. You must cross out item 2 above if you have been notified by the IRS that you are currently subject to backup withholding because you have failed to report all interest and dividends on your tax return. For real estate transactions, item 2 does not apply. For mortgage interest paid, acquisition or abandonment of secured property, cancellation of debt, contributions to an individual retirement arrangement (IRA), and generally, payments other than interest and dividends, you are not required to sign the certification, but you must provide your correct TIN. See the instructions for Part II, later.

Sign Here

Signature of U.S. person ▶

Date ▶

General Instructions

Section references are to the Internal Revenue Code unless otherwise noted.

Future developments. For the latest information about developments related to Form W-9 and its instructions, such as legislation enacted after they were published, go to www.irs.gov/FormW9.

Purpose of Form

An individual or entity (Form W-9 requester) who is required to file an information return with the IRS must obtain your correct taxpayer identification number (TIN) which may be your social security number (SSN), individual taxpayer identification number (ITIN), adoption taxpayer identification number (ATIN), or employer identification number (EIN), to report on an information return the amount paid to you, or other amount reportable on an information return. Examples of information returns include, but are not limited to, the following.

- Form 1099-INT (interest earned or paid)

- Form 1099-DIV (dividends, including those from stocks or mutual funds)
- Form 1099-MISC (various types of income, prizes, awards, or gross proceeds)
- Form 1099-B (stock or mutual fund sales and certain other transactions by brokers)
- Form 1099-S (proceeds from real estate transactions)
- Form 1099-K (merchant card and third party network transactions)
- Form 1098 (home mortgage interest), 1098-E (student loan interest), 1098-T (tuition)
- Form 1099-C (canceled debt)
- Form 1099-A (acquisition or abandonment of secured property)

Use Form W-9 only if you are a U.S. person (including a resident alien), to provide your correct TIN.

If you do not return Form W-9 to the requester with a TIN, you might be subject to backup withholding. See What is backup withholding, later.

By signing the filled-out form, you:

1. Certify that the TIN you are giving is correct (or you are waiting for a number to be issued),
2. Certify that you are not subject to backup withholding, or
3. Claim exemption from backup withholding if you are a U.S. exempt payee. If applicable, you are also certifying that as a U.S. person, your allocable share of any partnership income from a U.S. trade or business is not subject to the withholding tax on foreign partners' share of effectively connected income, and
4. Certify that FATCA code(s) entered on this form (if any) indicating that you are exempt from the FATCA reporting, is correct. See *What is FATCA reporting*, later, for further information.

Note: If you are a U.S. person and a requester gives you a form other than Form W-9 to request your TIN, you must use the requester's form if it is substantially similar to this Form W-9.

Definition of a U.S. person. For federal tax purposes, you are considered a U.S. person if you are:

- An individual who is a U.S. citizen or U.S. resident alien;
- A partnership, corporation, company, or association created or organized in the United States or under the laws of the United States;
- An estate (other than a foreign estate); or
- A domestic trust (as defined in Regulations section 301.7701-7).

Special rules for partnerships. Partnerships that conduct a trade or business in the United States are generally required to pay a withholding tax under section 1446 on any foreign partners' share of effectively connected taxable income from such business. Further, in certain cases where a Form W-9 has not been received, the rules under section 1446 require a partnership to presume that a partner is a foreign person, and pay the section 1446 withholding tax. Therefore, if you are a U.S. person that is a partner in a partnership conducting a trade or business in the United States, provide Form W-9 to the partnership to establish your U.S. status and avoid section 1446 withholding on your share of partnership income.

In the cases below, the following person must give Form W-9 to the partnership for purposes of establishing its U.S. status and avoiding withholding on its allocable share of net income from the partnership conducting a trade or business in the United States.

- In the case of a disregarded entity with a U.S. owner, the U.S. owner of the disregarded entity and not the entity;
- In the case of a grantor trust with a U.S. grantor or other U.S. owner, generally, the U.S. grantor or other U.S. owner of the grantor trust and not the trust; and
- In the case of a U.S. trust (other than a grantor trust), the U.S. trust (other than a grantor trust) and not the beneficiaries of the trust.

Foreign person. If you are a foreign person or the U.S. branch of a foreign bank that has elected to be treated as a U.S. person, do not use Form W-9. Instead, use the appropriate Form W-8 or Form 8233 (see Pub. 515, *Withholding of Tax on Nonresident Aliens and Foreign Entities*).

Nonresident alien who becomes a resident alien. Generally, only a nonresident alien individual may use the terms of a tax treaty to reduce or eliminate U.S. tax on certain types of income. However, most tax treaties contain a provision known as a "saving clause." Exceptions specified in the saving clause may permit an exemption from tax to continue for certain types of income even after the payee has otherwise become a U.S. resident alien for tax purposes.

If you are a U.S. resident alien who is relying on an exception contained in the saving clause of a tax treaty to claim an exemption from U.S. tax on certain types of income, you must attach a statement to Form W-9 that specifies the following five items.

1. The treaty country. Generally, this must be the same treaty under which you claimed exemption from tax as a nonresident alien.
2. The treaty article addressing the income.
3. The article number (or location) in the tax treaty that contains the saving clause and its exceptions.
4. The type and amount of income that qualifies for the exemption from tax.
5. Sufficient facts to justify the exemption from tax under the terms of the treaty article.

Example. Article 20 of the U.S.-China income tax treaty allows an exemption from tax for scholarship income received by a Chinese student temporarily present in the United States. Under U.S. law, this student will become a resident alien for tax purposes if his or her stay in the United States exceeds 5 calendar years. However, paragraph 2 of the first Protocol to the U.S.-China treaty (dated April 30, 1984) allows the provisions of Article 20 to continue to apply even after the Chinese student becomes a resident alien of the United States. A Chinese student who qualifies for this exception (under paragraph 2 of the first protocol) and is relying on this exception to claim an exemption from tax on his or her scholarship or fellowship income would attach to Form W-9 a statement that includes the information described above to support that exemption.

If you are a nonresident alien or a foreign entity, give the requester the appropriate completed Form W-8 or Form 8233.

Backup Withholding

What is backup withholding? Persons making certain payments to you must under certain conditions withhold and pay to the IRS 24% of such payments. This is called "backup withholding." Payments that may be subject to backup withholding include interest, tax-exempt interest, dividends, broker and barter exchange transactions, rents, royalties, nonemployee pay, payments made in settlement of payment card and third party network transactions, and certain payments from fishing boat operators. Real estate transactions are not subject to backup withholding.

You will not be subject to backup withholding on payments you receive if you give the requester your correct TIN, make the proper certifications, and report all your taxable interest and dividends on your tax return.

Payments you receive will be subject to backup withholding if:

1. You do not furnish your TIN to the requester,
2. You do not certify your TIN when required (see the instructions for Part II for details),
3. The IRS tells the requester that you furnished an incorrect TIN,
4. The IRS tells you that you are subject to backup withholding because you did not report all your interest and dividends on your tax return (for reportable interest and dividends only), or
5. You do not certify to the requester that you are not subject to backup withholding under 4 above (for reportable interest and dividend accounts opened after 1983 only).

Certain payees and payments are exempt from backup withholding. See *Exempt payee code*, later, and the separate Instructions for the Requester of Form W-9 for more information.

Also see *Special rules for partnerships*, earlier.

What is FATCA Reporting?

The Foreign Account Tax Compliance Act (FATCA) requires a participating foreign financial institution to report all United States account holders that are specified United States persons. Certain payees are exempt from FATCA reporting. See *Exemption from FATCA reporting code*, later, and the Instructions for the Requester of Form W-9 for more information.

Updating Your Information

You must provide updated information to any person to whom you claimed to be an exempt payee if you are no longer an exempt payee and anticipate receiving reportable payments in the future from this person. For example, you may need to provide updated information if you are a C corporation that elects to be an S corporation, or if you no longer are tax exempt. In addition, you must furnish a new Form W-9 if the name or TIN changes for the account; for example, if the grantor of a grantor trust dies.

Penalties

Failure to furnish TIN. If you fail to furnish your correct TIN to a requester, you are subject to a penalty of \$50 for each such failure unless your failure is due to reasonable cause and not to willful neglect.

Civil penalty for false information with respect to withholding. If you make a false statement with no reasonable basis that results in no backup withholding, you are subject to a \$500 penalty.

Criminal penalty for falsifying information. Willfully falsifying certifications or affirmations may subject you to criminal penalties including fines and/or imprisonment.

Misuse of TINs. If the requester discloses or uses TINs in violation of federal law, the requester may be subject to civil and criminal penalties.

Specific Instructions

Line 1

You must enter one of the following on this line; **do not** leave this line blank. The name should match the name on your tax return.

If this Form W-9 is for a joint account (other than an account maintained by a foreign financial institution (FFI)), list first, and then circle, the name of the person or entity whose number you entered in Part I of Form W-9. If you are providing Form W-9 to an FFI to document a joint account, each holder of the account that is a U.S. person must provide a Form W-9.

a. **Individual.** Generally, enter the name shown on your tax return. If you have changed your last name without informing the Social Security Administration (SSA) of the name change, enter your first name, the last name as shown on your social security card, and your new last name.

Note: ITIN applicant: Enter your individual name as it was entered on your Form W-7 application, line 1a. This should also be the same as the name you entered on the Form 1040/1040A/1040EZ you filed with your application.

b. **Sole proprietor or single-member LLC.** Enter your individual name as shown on your 1040/1040A/1040EZ on line 1. You may enter your business, trade, or “doing business as” (DBA) name on line 2.

c. **Partnership, LLC that is not a single-member LLC, C corporation, or S corporation.** Enter the entity’s name as shown on the entity’s tax return on line 1 and any business, trade, or DBA name on line 2.

d. **Other entities.** Enter your name as shown on required U.S. federal tax documents on line 1. This name should match the name shown on the charter or other legal document creating the entity. You may enter any business, trade, or DBA name on line 2.

e. **Disregarded entity.** For U.S. federal tax purposes, an entity that is disregarded as an entity separate from its owner is treated as a “disregarded entity.” See Regulations section 301.7701-2(c)(2)(iii). Enter the owner’s name on line 1. The name of the entity entered on line 1 should never be a disregarded entity. The name on line 1 should be the name shown on the income tax return on which the income should be reported. For example, if a foreign LLC that is treated as a disregarded entity for U.S. federal tax purposes has a single owner that is a U.S. person, the U.S. owner’s name is required to be provided on line 1. If the direct owner of the entity is also a disregarded entity, enter the first owner that is not disregarded for federal tax purposes. Enter the disregarded entity’s name on line 2, “Business name/disregarded entity name.” If the owner of the disregarded entity is a foreign person, the owner must complete an appropriate Form W-8 instead of a Form W-9. This is the case even if the foreign person has a U.S. TIN.

Line 2

If you have a business name, trade name, DBA name, or disregarded entity name, you may enter it on line 2.

Line 3

Check the appropriate box on line 3 for the U.S. federal tax classification of the person whose name is entered on line 1. Check only one box on line 3.

IF the entity/person on line 1 is a(n) . . .	THEN check the box for . . .
• Corporation	Corporation
• Individual • Sole proprietorship, or • Single-member limited liability company (LLC) owned by an individual and disregarded for U.S. federal tax purposes.	Individual/sole proprietor or single-member LLC
• LLC treated as a partnership for U.S. federal tax purposes, • LLC that has filed Form 8832 or 2553 to be taxed as a corporation, or • LLC that is disregarded as an entity separate from its owner but the owner is another LLC that is not disregarded for U.S. federal tax purposes.	Limited liability company and enter the appropriate tax classification. (P= Partnership; C= C corporation; or S= S corporation)
• Partnership	Partnership
• Trust/estate	Trust/estate

Line 4, Exemptions

If you are exempt from backup withholding and/or FATCA reporting, enter in the appropriate space on line 4 any code(s) that may apply to you.

Exempt payee code.

- Generally, individuals (including sole proprietors) are not exempt from backup withholding.
- Except as provided below, corporations are exempt from backup withholding for certain payments, including interest and dividends.
- Corporations are not exempt from backup withholding for payments made in settlement of payment card or third party network transactions.
- Corporations are not exempt from backup withholding with respect to attorneys’ fees or gross proceeds paid to attorneys, and corporations that provide medical or health care services are not exempt with respect to payments reportable on Form 1099-MISC.

The following codes identify payees that are exempt from backup withholding. Enter the appropriate code in the space in line 4.

- 1—An organization exempt from tax under section 501(a), any IRA, or a custodial account under section 403(b)(7) if the account satisfies the requirements of section 401(f)(2)
- 2—The United States or any of its agencies or instrumentalities
- 3—A state, the District of Columbia, a U.S. commonwealth or possession, or any of their political subdivisions or instrumentalities
- 4—A foreign government or any of its political subdivisions, agencies, or instrumentalities
- 5—A corporation
- 6—A dealer in securities or commodities required to register in the United States, the District of Columbia, or a U.S. commonwealth or possession
- 7—A futures commission merchant registered with the Commodity Futures Trading Commission
- 8—A real estate investment trust
- 9—An entity registered at all times during the tax year under the Investment Company Act of 1940
- 10—A common trust fund operated by a bank under section 584(a)
- 11—A financial institution
- 12—A middleman known in the investment community as a nominee or custodian
- 13—A trust exempt from tax under section 664 or described in section 4947

The following chart shows types of payments that may be exempt from backup withholding. The chart applies to the exempt payees listed above, 1 through 13.

IF the payment is for . . .	THEN the payment is exempt for . . .
Interest and dividend payments	All exempt payees except for 7
Broker transactions	Exempt payees 1 through 4 and 6 through 11 and all C corporations. S corporations must not enter an exempt payee code because they are exempt only for sales of noncovered securities acquired prior to 2012.
Barter exchange transactions and patronage dividends	Exempt payees 1 through 4
Payments over \$600 required to be reported and direct sales over \$5,000 ¹	Generally, exempt payees 1 through 5 ²
Payments made in settlement of payment card or third party network transactions	Exempt payees 1 through 4

¹ See Form 1099-MISC, Miscellaneous Income, and its instructions.

² However, the following payments made to a corporation and reportable on Form 1099-MISC are not exempt from backup withholding: medical and health care payments, attorneys' fees, gross proceeds paid to an attorney reportable under section 6045(f), and payments for services paid by a federal executive agency.

Exemption from FATCA reporting code. The following codes identify payees that are exempt from reporting under FATCA. These codes apply to persons submitting this form for accounts maintained outside of the United States by certain foreign financial institutions. Therefore, if you are only submitting this form for an account you hold in the United States, you may leave this field blank. Consult with the person requesting this form if you are uncertain if the financial institution is subject to these requirements. A requester may indicate that a code is not required by providing you with a Form W-9 with "Not Applicable" (or any similar indication) written or printed on the line for a FATCA exemption code.

A—An organization exempt from tax under section 501(a) or any individual retirement plan as defined in section 7701(a)(37)

B—The United States or any of its agencies or instrumentalities

C—A state, the District of Columbia, a U.S. commonwealth or possession, or any of their political subdivisions or instrumentalities

D—A corporation the stock of which is regularly traded on one or more established securities markets, as described in Regulations section 1.1472-1(c)(1)(i)

E—A corporation that is a member of the same expanded affiliated group as a corporation described in Regulations section 1.1472-1(c)(1)(i)

F—A dealer in securities, commodities, or derivative financial instruments (including notional principal contracts, futures, forwards, and options) that is registered as such under the laws of the United States or any state

G—A real estate investment trust

H—A regulated investment company as defined in section 851 or an entity registered at all times during the tax year under the Investment Company Act of 1940

I—A common trust fund as defined in section 584(a)

J—A bank as defined in section 581

K—A broker

L—A trust exempt from tax under section 664 or described in section 4947(a)(1)

M—A tax exempt trust under a section 403(b) plan or section 457(g) plan

Note: You may wish to consult with the financial institution requesting this form to determine whether the FATCA code and/or exempt payee code should be completed.

Line 5

Enter your address (number, street, and apartment or suite number). This is where the requester of this Form W-9 will mail your information returns. If this address differs from the one the requester already has on file, write NEW at the top. If a new address is provided, there is still a chance the old address will be used until the payor changes your address in their records.

Line 6

Enter your city, state, and ZIP code.

Part I. Taxpayer Identification Number (TIN)

Enter your TIN in the appropriate box. If you are a resident alien and you do not have and are not eligible to get an SSN, your TIN is your IRS individual taxpayer identification number (ITIN). Enter it in the social security number box. If you do not have an ITIN, see *How to get a TIN* below.

If you are a sole proprietor and you have an EIN, you may enter either your SSN or EIN.

If you are a single-member LLC that is disregarded as an entity separate from its owner, enter the owner's SSN (or EIN, if the owner has one). Do not enter the disregarded entity's EIN. If the LLC is classified as a corporation or partnership, enter the entity's EIN.

Note: See *What Name and Number To Give the Requester*, later, for further clarification of name and TIN combinations.

How to get a TIN. If you do not have a TIN, apply for one immediately. To apply for an SSN, get Form SS-5, Application for a Social Security Card, from your local SSA office or get this form online at www.SSA.gov. You may also get this form by calling 1-800-772-1213. Use Form W-7, Application for IRS Individual Taxpayer Identification Number, to apply for an ITIN, or Form SS-4, Application for Employer Identification Number, to apply for an EIN. You can apply for an EIN online by accessing the IRS website at www.irs.gov/Businesses and clicking on Employer Identification Number (EIN) under Starting a Business. Go to www.irs.gov/Forms to view, download, or print Form W-7 and/or Form SS-4. Or, you can go to www.irs.gov/OrderForms to place an order and have Form W-7 and/or SS-4 mailed to you within 10 business days.

If you are asked to complete Form W-9 but do not have a TIN, apply for a TIN and write "Applied For" in the space for the TIN, sign and date the form, and give it to the requester. For interest and dividend payments, and certain payments made with respect to readily tradable instruments, generally you will have 60 days to get a TIN and give it to the requester before you are subject to backup withholding on payments. The 60-day rule does not apply to other types of payments. You will be subject to backup withholding on all such payments until you provide your TIN to the requester.

Note: Entering "Applied For" means that you have already applied for a TIN or that you intend to apply for one soon.

Caution: A disregarded U.S. entity that has a foreign owner must use the appropriate Form W-8.

Part II. Certification

To establish to the withholding agent that you are a U.S. person, or resident alien, sign Form W-9. You may be requested to sign by the withholding agent even if item 1, 4, or 5 below indicates otherwise.

For a joint account, only the person whose TIN is shown in Part I should sign (when required). In the case of a disregarded entity, the person identified on line 1 must sign. Exempt payees, see *Exempt payee code*, earlier.

Signature requirements. Complete the certification as indicated in items 1 through 5 below.

1. Interest, dividend, and barter exchange accounts opened before 1984 and broker accounts considered active during 1983.

You must give your correct TIN, but you do not have to sign the certification.

2. Interest, dividend, broker, and barter exchange accounts opened after 1983 and broker accounts considered inactive during 1983.

You must sign the certification or backup withholding will apply. If you are subject to backup withholding and you are merely providing your correct TIN to the requester, you must cross out item 2 in the certification before signing the form.

3. Real estate transactions.

You must sign the certification. You may cross out item 2 of the certification.

4. Other payments. You must give your correct TIN, but you do not have to sign the certification unless you have been notified that you have previously given an incorrect TIN. "Other payments" include payments made in the course of the requester's trade or business for rents, royalties, goods (other than bills for merchandise), medical and health care services (including payments to corporations), payments to a nonemployee for services, payments made in settlement of payment card and third party network transactions, payments to certain fishing boat crew members and fishermen, and gross proceeds paid to attorneys (including payments to corporations).

5. Mortgage interest paid by you, acquisition or abandonment of secured property, cancellation of debt, qualified tuition program payments (under section 529), ABLE accounts (under section 529A), IRA, Coverdell ESA, Archer MSA or HSA contributions or distributions, and pension distributions. You must give your correct TIN, but you do not have to sign the certification.

What Name and Number To Give the Requester

For this type of account:	Give name and SSN of:
1. Individual	The individual
2. Two or more individuals (joint account) other than an account maintained by an FFI	The actual owner of the account or, if combined funds, the first individual on the account ¹
3. Two or more U.S. persons (joint account maintained by an FFI)	Each holder of the account
4. Custodial account of a minor (Uniform Gift to Minors Act)	The minor ²
5. a. The usual revocable savings trust (grantor is also trustee)	The grantor-trustee ¹
b. So-called trust account that is not a legal or valid trust under state law	The actual owner ¹
6. Sole proprietorship or disregarded entity owned by an individual	The owner ³
7. Grantor trust filing under Optional Form 1099 Filing Method 1 (see Regulations section 1.671-4(b)(2)(i)(A))	The grantor*
For this type of account:	Give name and EIN of:
8. Disregarded entity not owned by an individual	The owner
9. A valid trust, estate, or pension trust	Legal entity ⁴
10. Corporation or LLC electing corporate status on Form 8832 or Form 2553	The corporation
11. Association, club, religious, charitable, educational, or other tax-exempt organization	The organization
12. Partnership or multi-member LLC	The partnership
13. A broker or registered nominee	The broker or nominee

For this type of account:	Give name and EIN of:
14. Account with the Department of Agriculture in the name of a public entity (such as a state or local government, school district, or prison) that receives agricultural program payments	The public entity
15. Grantor trust filing under the Form 1041 Filing Method or the Optional Form 1099 Filing Method 2 (see Regulations section 1.671-4(b)(2)(i)(B))	The trust

¹ List first and circle the name of the person whose number you furnish. If only one person on a joint account has an SSN, that person's number must be furnished.

² Circle the minor's name and furnish the minor's SSN.

³ You must show your individual name and you may also enter your business or DBA name on the "Business name/disregarded entity" name line. You may use either your SSN or EIN (if you have one), but the IRS encourages you to use your SSN.

⁴ List first and circle the name of the trust, estate, or pension trust. (Do not furnish the TIN of the personal representative or trustee unless the legal entity itself is not designated in the account title.) Also see *Special rules for partnerships*, earlier.

*Note: The grantor also must provide a Form W-9 to trustee of trust.

Note: If no name is circled when more than one name is listed, the number will be considered to be that of the first name listed.

Secure Your Tax Records From Identity Theft

Identity theft occurs when someone uses your personal information such as your name, SSN, or other identifying information, without your permission, to commit fraud or other crimes. An identity thief may use your SSN to get a job or may file a tax return using your SSN to receive a refund.

To reduce your risk:

- Protect your SSN,
- Ensure your employer is protecting your SSN, and
- Be careful when choosing a tax preparer.

If your tax records are affected by identity theft and you receive a notice from the IRS, respond right away to the name and phone number printed on the IRS notice or letter.

If your tax records are not currently affected by identity theft but you think you are at risk due to a lost or stolen purse or wallet, questionable credit card activity or credit report, contact the IRS Identity Theft Hotline at 1-800-908-4490 or submit Form 14039.

For more information, see Pub. 5027, Identity Theft Information for Taxpayers.

Victims of identity theft who are experiencing economic harm or a systemic problem, or are seeking help in resolving tax problems that have not been resolved through normal channels, may be eligible for Taxpayer Advocate Service (TAS) assistance. You can reach TAS by calling the TAS toll-free case intake line at 1-877-777-4778 or TTY/TDD 1-800-829-4059.

Protect yourself from suspicious emails or phishing schemes.

Phishing is the creation and use of email and websites designed to mimic legitimate business emails and websites. The most common act is sending an email to a user falsely claiming to be an established legitimate enterprise in an attempt to scam the user into surrendering private information that will be used for identity theft.

The IRS does not initiate contacts with taxpayers via emails. Also, the IRS does not request personal detailed information through email or ask taxpayers for the PIN numbers, passwords, or similar secret access information for their credit card, bank, or other financial accounts.

If you receive an unsolicited email claiming to be from the IRS, forward this message to phishing@irs.gov. You may also report misuse of the IRS name, logo, or other IRS property to the Treasury Inspector General for Tax Administration (TIGTA) at 1-800-366-4484. You can forward suspicious emails to the Federal Trade Commission at spam@uce.gov or report them at www.ftc.gov/complaint. You can contact the FTC at www.ftc.gov/idtheft or 877-IDTHEFT (877-438-4338). If you have been the victim of identity theft, see www.IdentityTheft.gov and Pub. 5027.

Visit www.irs.gov/IdentityTheft to learn more about identity theft and how to reduce your risk.

Privacy Act Notice

Section 6109 of the Internal Revenue Code requires you to provide your correct TIN to persons (including federal agencies) who are required to file information returns with the IRS to report interest, dividends, or certain other income paid to you; mortgage interest you paid; the acquisition or abandonment of secured property; the cancellation of debt; or contributions you made to an IRA, Archer MSA, or HSA. The person collecting this form uses the information on the form to file information returns with the IRS, reporting the above information. Routine uses of this information include giving it to the Department of Justice for civil and criminal litigation and to cities, states, the District of Columbia, and U.S. commonwealths and possessions for use in administering their laws. The information also may be disclosed to other countries under a treaty, to federal and state agencies to enforce civil and criminal laws, or to federal law enforcement and intelligence agencies to combat terrorism. You must provide your TIN whether or not you are required to file a tax return. Under section 3406, payers must generally withhold a percentage of taxable interest, dividend, and certain other payments to a payee who does not give a TIN to the payer. Certain penalties may also apply for providing false or fraudulent information.